

CATALOG
117

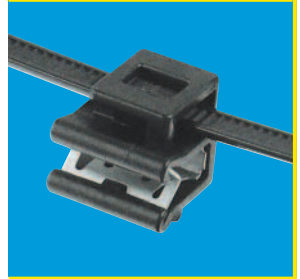

a PennEngineering® Company

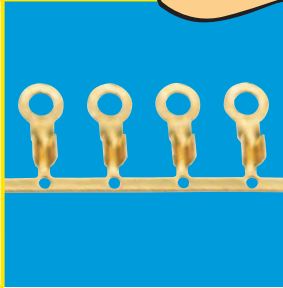
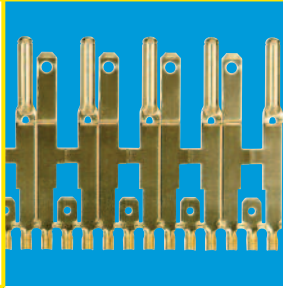
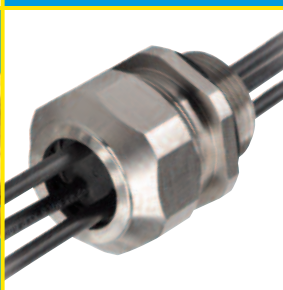
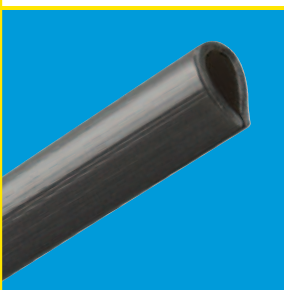
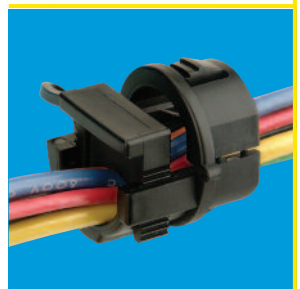
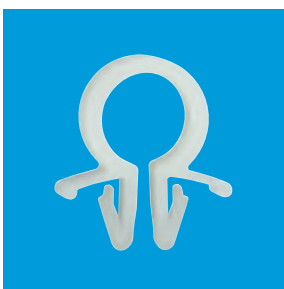
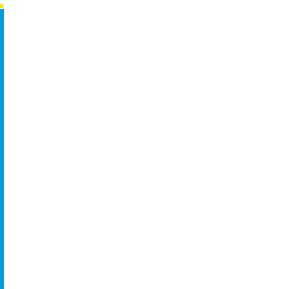

Heyco's Global Sales Network

Heyco – North America
(Includes Canada and Mexico)
northamericasales@heyco.com

Heyco – Europe
europesales@heyco.com

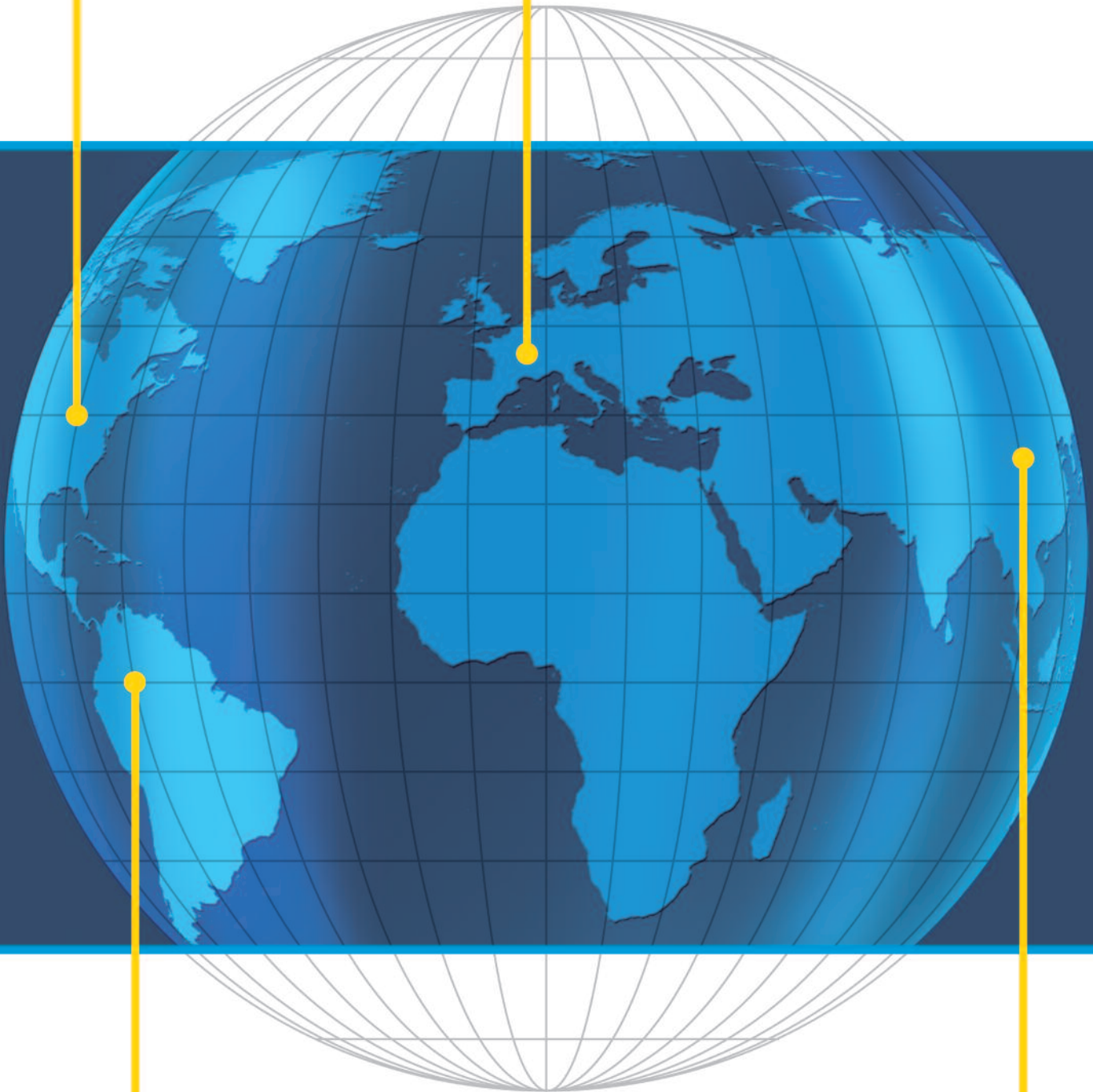

Heyco – Central and South America
csasales@heyco.com

Heyco – Asia
asiasales@heyco.com

"Stay Connected" with



Power Components

a PennEngineering® Company

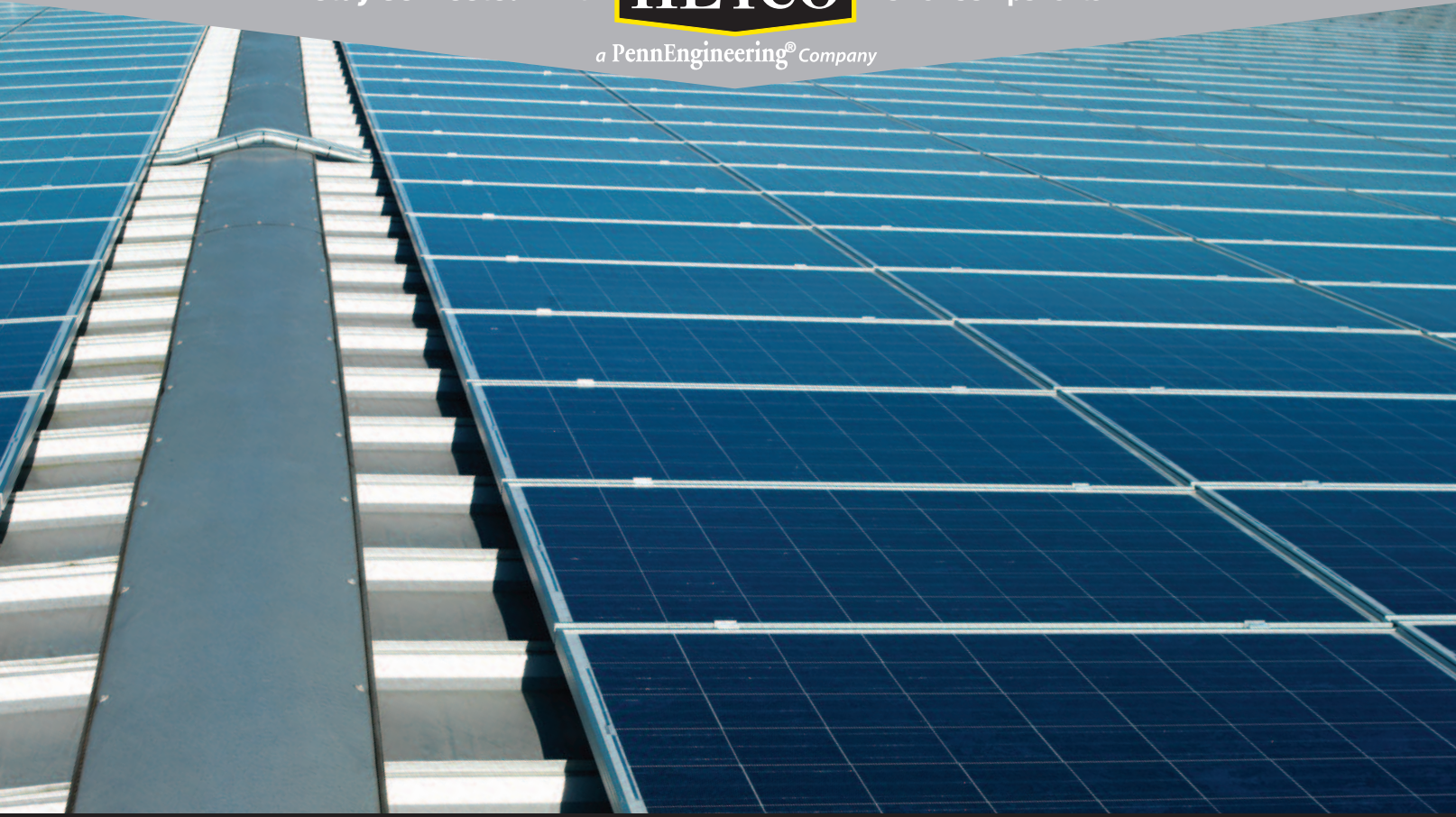

Solar Panel Array and Solar Masthead® II Cordgrips and Heyco-Flex™ I Conduit on the rooftop of Heyco Products, Inc., Toms River, NJ Headquarters and Manufacturing Facility.

www.heyco.com

HEYCO®
Solar Power
Components



1-1 Heyco-Tite Solar Masthead II Nylon Liquid Tight Cordgrips

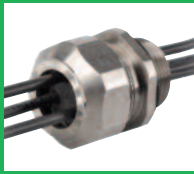

1-2 Heyco-Tite Solar Masthead Metal Liquid Tight Cordgrips



1-3 Heyco-Tite UL Listed/Recognized & CSA Certified LTCGs



1-4 HEYClip SunRunner Cable Clips



1-5 HEYClip SunRunner 90° Cable Clips



1-6 HEYClip SunRunner 2-S Series Cable Clips



1-6 HEYClip CT Cable Tie Mounting Platforms



1-7 HEYClip Stainless Steel SunRunner 2 Series Cable Clips



1-8 HEYClip Nylon UVX SunRunner 2 Series Cable Clips

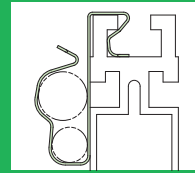

1-9 HEYClip Stainless Steel & Nylon UVX SunRunner 2 Series Rack Profiles



1-9 HEYClip Vinyl Coated Spring Clamps



1-10 HEYClip MaxRunner Cable Clip Arrays - Clip and Flush Mount



1-11 Nytyes with Stainless Steel Locking Device



1-11 SunBundler PVC Coated Stainless Steel Wire Cable Ties



1-12 Stainless Steel Cable Ties with Ball Lock AISI 304 & 316



1-13 Edge Clip Nytyes

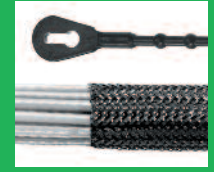

1-14 Beaded Ties & Braided Sleeving



1-15 SunWrap - Polyethylene & Heavy Duty Cable Guard



1-16 SunWrap - Nylon



1-16 Heyco-Flex V Nylon Slit Tubing



1-17 Copper and Aluminum LugRunners



1-17 SunJumpers



1-17 SunStars



1-18 SunClamp Stainless Steel Cable Clamps



1-18 Steel Cushion Clamps



1-19 PVB 101 Single Diode Solar Junction Box



1-20 PVB 301 Multi-Diode Solar Junction Box



1-21 PVB 001 Diodeless Solar Junction Boxes and Mounting Plate



1-22 CPV Solar Bulkhead Connectors



1-23 & 1-24 CPV Solar Connectors & Connector Sets



1-25 SunScreener Wire Mesh Clip & SunScreen Wire Mesh

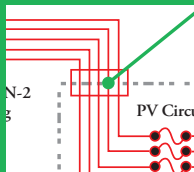

1-26 Where Used Schematic



1-27 Solar Power Components LabKit

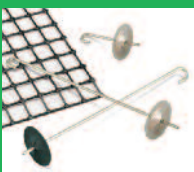

1-27 SunScreen Kit



1-27 Heyco Solar Warranty

For a list of our Solar Distributors visit heycosolar.com



“Stay Connected” with



Solar Power Components

a PennEngineering® Company



Heyco®-Tite Solar Masthead® II Liquid Tight Cordgrips

Multi-Hole, NPT Hubs with Integral Sealing Ring - IP 68 Rated

The Ultimate in Liquid Tight Strain Relief Protection

Small Packs Available

GLAND CONFIGURATION			PART NO.	DESCRIPTION with NPT Thread	PACKAGING		UL/CS or cUL/US	PART DIMENSIONS															
Size mm.	Type *	No.			Black	Std. Pack		Small Pack †	A Clearance Hole Dia.		B Max. O.A. Length		C Thread Length		D Wrenching Nut Thickness		E Flat Size						
							in.	mm.	in.	mm.	in.	mm.	in.	mm.	in.	mm.							
5,5	USE-2	5	M3234GGBR-SM	SMCG 3/4	100	25	UL/CS	1.040	26,4	2.00	50,8	.62	15,7	.25	6,4	1.30	33,0						
		9	M8437GBK-SM	SMCG 1	100	25	UL/CS	1.326	33,8	2.41	61,2	.76	19,3	.30	7,6	1.73	43,9						
		13	M4524GBM-SM	SMCG 1-1/4	50	10	UL/CS	1.680	42,7	2.69	68,3	.78	19,8	.30	7,6	2.05	52,1						
		21	M3317GBQ-SM	SMCG 1-1/2	50	5	UL/CS	1.920	48,8	2.81	71,3	.76	19,3	.36	9,1	2.46	62,5						
		31	M3321GBY-SM	SMCG 2	50	5	UL/CS	2.400	60,8	2.93	74,3	.79	20,1	.42	10,7	2.73	69,3						
5,6	USE-2	3	M3200GAH-SM	SMCG LL 1/2	200	25	UL/CS	.875	22,2	1.68	42,7	.44	11,2	.25	6,4	1.06	26,9						
7,7	PV 1000 or USE-2 **	3	M3234GBS-SM	SMCG 3/4	100	25	UL/CS	1.040	26,4	2.00	50,8	.62	15,7	.25	6,4	1.30	33,0						
		5	M8437GBT-SM	SMCG 1	100	25	UL/CS	1.326	33,8	2.41	61,2	.76	19,3	.30	7,6	1.73	43,9						
		9	M4524GBW-SM	SMCG 1-1/4	50	10	UL/CS	1.680	42,7	2.69	68,3	.78	19,8	.30	7,6	2.05	52,1						
		11	M3317GBZ-SM	SMCG 1-1/2	50	5	UL/CS	1.920	48,8	2.81	71,3	.76	19,3	.36	9,1	2.46	62,5						
		19	M3321GBX-SM	SMCG 2	50	5	UL/CS	2.400	60,8	2.93	74,3	.79	20,1	.42	10,7	2.73	69,3						
8,9	PV 1000	7	M4524GCJ-SM	SMCG 1-1/4	50	10	UL/CS	1.680	42,7	2.69	68,3	.78	19,8	.30	7,6	2.05	52,1						
		9	M3317GCK-SM	SMCG 1-1/2	50	5	UL/CS	1.920	48,8	2.81	71,3	.76	19,3	.36	9,1	2.46	62,5						
		12	M3321GCM-SM	SMCG 2	50	5	UL/CS	2.400	60,8	2.93	74,3	.79	20,1	.42	10,7	2.73	69,3						

*AWG 10 and 12 for both USE-2 and PV 1000. **For 8 AWG USE-2 Wire.

† To order **Small Packs**, please add the suffix **-P** to Part No.; e.g., M3234GGBR-SM-P.

- **Break-Thru Skinned-Over glands** in the Solar Masthead II Cordgrips offer flexibility to use from 1 to 31 of the available holes while still providing a liquid tight seal around the wire.
- **IP 68 rated.**
- Approved for **NEMA 4, 4X, 6 and 6P** applications.
- **Integral Sealing Ring** ensures a superior seal at the clearance or threaded mounting hole location, every time.
- Provide a watertight seal for PV module output leads to inverters.
- Designed for solar rooftop or combiner box installations.
- Secure input PV leads from solar panel array strings to fuse holder hookup within solar combiner boxes.
- Use in some residential rooftop solar applications may eliminate the need for combiner box when appropriate threaded adaptor is used.
- UV resistant nylon construction with TPE Sealing Gland resists salt water, weak acids, gasoline, alcohol, oil, grease, and common solvents.
- No disassembly required for installation.
- Generous wrenching flats for ease of assembly.
- **Solar Masthead II Cordgrips provided with assembled metal locknut.**

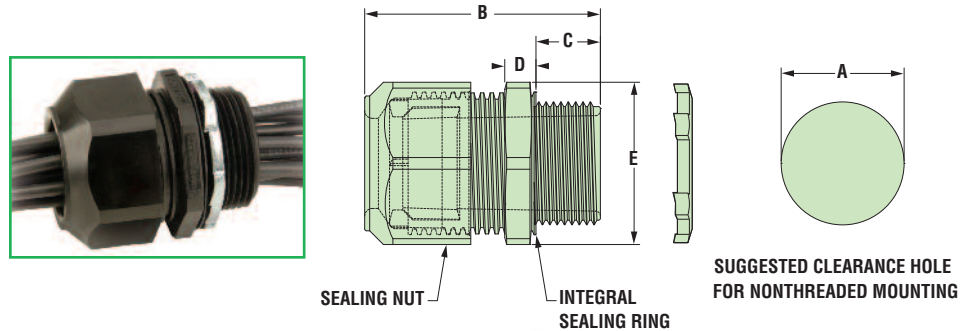

See page 2-7 for details

Use a Heyco-Flex I Conduit Adapter to join a Heyco Solar Masthead to Heyco-Flex I or Rigid PVC Conduit, through which the solar installer can run PV wire from the roof to the field level inverter.

Material	Nylon 6/6 with TPE Sealing Glands
Certifications	<ul style="list-style-type: none"> UL Listed under Underwriters' Laboratories File E51579 cUL/US Recognized under the Component Program of Underwriters' Laboratories File E51579 to both Canadian and U.S. requirements CS Certified by the Canadian Standards Association File 93876
Flammability Rating	94-V2
Temperature Range	Static -40°F (-40°C) to 239°F (115°C) Dynamic -4°F (-20°C) to 212°F (100°C)
IP Rating	IP 68



Heyco® -Tite Solar Masthead® Metal Liquid Tight Cordgrips

Multi-Hole, NPT Hubs - IP 68 Rated

The Ultimate in Liquid Tight Strain Relief Protection



GLAND CONFIGURATION Conductors			PART NO.	DESCRIPTION	PACKAGING Standard Pack		A Clearance Hole Dia.		B Max. O.A. Length		C Thread Length		D Wrenching Nut Thickness		E Flat Size	
Size mm.	Type *	No.					in.	mm.	in.	mm.	in.	mm.	in.	mm.	in.	mm.
Stainless Steel																
5.5	USE-2	9	M6013GBK-SM	SSMCG 1	25		1.375	34,9	2.22	56,4	.69	17,5	.20	5,1	1.75	44,5
		13	M6016GBM-SM	SSMCG 1-1/4	10		1.734	44,0	2.61	65,0	.71	18,0	.25	6,4	2.25	57,2
		21	M6018GBQ-SM	SSMCG 1-1/2	5		1.984	50,4	2.69	67,1	.73	18,5	.25	6,4	2.50	63,5
		31	M6020GBY-SM	SSMCG 2	5		2.469	62,7	2.92	74,2	.76	19,3	.25	6,4	2.75	69,9
7.7	PV 1000	5	M6013GBT-SM	SSMCG 1	25		1.375	34,9	2.22	56,4	.69	17,5	.20	5,1	1.75	44,5
		9	M6016GBW-SM	SSMCG 1-1/4	10		1.734	44,0	2.61	65,0	.71	18,0	.25	6,4	2.25	57,2
		11	M6018GBZ-SM	SSMCG 1-1/2	5		1.984	50,4	2.69	67,1	.73	18,5	.25	6,4	2.50	63,5
		19	M6020GBX-SM	SSMCG 2	5		2.469	62,7	2.92	74,2	.76	19,3	.25	6,4	2.75	69,9
8.9	PV 1000**	7	M6016GCJ-SM	SSMCG 1-1/4	10		1.734	44,0	2.61	65,0	.71	18,0	.25	6,4	2.25	57,2
		9	M6018GCK-SM	SSMCG 1-1/2	5		1.984	50,4	2.69	67,1	.73	18,5	.25	6,4	2.50	63,5
		12	M6020GCM-SM	SSMCG 2	5		2.469	62,7	2.92	74,2	.76	19,3	.25	6,4	2.75	69,9
Aluminum																
5.5	USE-2	9	M6113GBK-SM	ALMCG 1	25		1.375	34,9	2.22	56,4	.69	17,5	.20	5,1	1.75	44,5
		13	M6116GBM-SM	ALMCG 1-1/4	10		1.734	44,0	2.61	65,0	.71	18,0	.25	6,4	2.25	57,2
		21	M6118GBQ-SM	ALMCG 1-1/2	5		1.984	50,4	2.69	67,1	.73	18,5	.25	6,4	2.50	63,5
		31	M6120GBY-SM	ALMCG 2	5		2.469	62,7	2.92	74,2	.76	19,3	.25	6,4	2.75	69,9
7.7	PV 1000	5	M6113GBT-SM	ALMCG 1	25		1.375	34,9	2.22	56,4	.69	17,5	.20	5,1	1.75	44,5
		9	M6116GBW-SM	ALMCG 1-1/4	10		1.734	44,0	2.61	65,0	.71	18,0	.25	6,4	2.25	57,2
		11	M6118GBZ-SM	ALMCG 1-1/2	5		1.984	50,4	2.69	67,1	.73	18,5	.25	6,4	2.50	63,5
		19	M6120GBX-SM	ALMCG 2	5		2.469	62,7	2.92	74,2	.76	19,3	.25	6,4	2.75	69,9
8.9	PV 1000**	7	M6116GCJ-SM	ALMCG 1-1/4	10		1.734	44,0	2.61	65,0	.71	18,0	.25	6,4	2.25	57,2
		9	M6118GCK-SM	ALMCG 1-1/2	5		1.984	50,4	2.69	67,1	.73	18,5	.25	6,4	2.50	63,5
		12	M6120GCM-SM	ALMCG 2	5		2.469	62,7	2.92	74,2	.76	19,3	.25	6,4	2.75	69,9

* AWG 10 and 12 for both USE-2 and PV 1000
 ** For 8 AWG USE-2 Wire, use Solar Mastheads for 7,7 mm conductors.
Assembled Metal Locknuts INCLUDED.

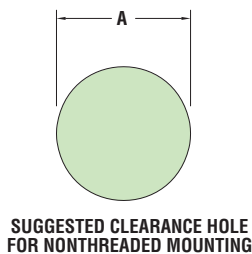
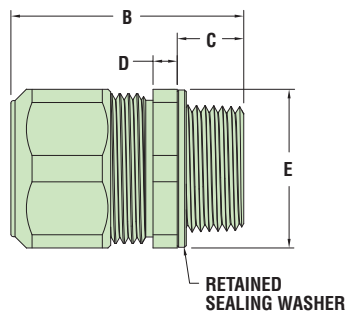

Material	SSMCG: 303 Stainless Body and sealing nut with Nylon 6/6 finger and TPE Gland ALMCG: 6061 Aluminum body and sealing nut with Nylon 6/6 finger and TPE Gland
Certifications	Certified by UL for Compliance with both Canadian and US requirements under File E51579 Recognized under the Component Program of Underwriters' Laboratories File E51579 to both Canadian and US requirements
Flammability Rating	94V-2
Temperature Range	-40°F (-40°C) to 212°F (100°C)
IP Rating	IP 68 (70 PSI, 5 BAR)

- Break-Thru Skinned-Over glands offer flexibility to use from 1 to 31 of the available holes while still providing a liquid tight seal around the wire.
- Rolled grease-free threads prevent galling and allow for multiple assemblies and disassemblies.
- Approved for NEMA 4, 4X, 6 and 6P applications.
- Self-retaining sealing washers eliminate the need for an O-Ring groove, thus reducing cost.
- Stainless Steel ideal for corrosive environments.
- Aluminum a less costly solution for robust environments.
- Provide a watertight seal for PV module output leads to inverters.
- Secure input PV leads from solar panel array strings to fuse holder hookup within solar combiner boxes.
- No disassembly required for installation.
- Sealing washer required for through hole applications only.
- DFARS Compliant.

“Stay Connected” with



Solar Power Components

a PennEngineering® Company



Heyco®-Tite UL Listed/Recognized and CSA Certified Liquid Tight Cordgrips for Solar Applications

Multi-Hole, NPT Hubs with Integral Sealing Ring - IP 68 Rated

The Ultimate in Liquid Tight Strain Relief Protection

- Integral Sealing Ring ensures a superior seal at the clearance or threaded mounting hole location, every time.
- IP 68 rated.
- Widest range of approved cable diameters.
- Cordgrips with an -SM suffix have Skinned-Over Break-thru glands that offer the flexibility to use from 1 to 31 of the available holes while still providing a liquid tight seal around the wire.
- All accompanying Cordgrips are made of nylon construction with TPE sealing glands that resist salt water, weak acids, gasoline, alcohol, oil, grease, and common solvents. (This feature is not assessed by UL.)
- For locknut specifications or to order locknuts separately, see pages 3-47 & 3-48.
- Multi-hole glands are only to be used with Heyco Liquid Tight Cordgrips and are not sold separately.
- For our complete range of Heyco Cordgrips, see Section 3.

GLAND CONFIGURATION	CONDUCTORS	PART NUMBER	DESCRIPTION	UL/CSA or cRU/US	PART DIMENSIONS											
					A	B	C	D	E	Wrenching Nut						
Size mm.	Type *	No.	Black		Clearance Hole Dia.	Max. O.A. Length	Thread Length	Thickness	Flat Size							
					in.	mm.	in.	mm.	in.	mm.	in.	mm.	in.	mm.		
Standard Multi-Hole Gland - Assembled Metal Locknuts INCLUDED																
4,5	USE-2	9	M8437GBF	LTCG 1	cRU/US	1.326	33,8	2.41	61,2	.76	19,3	.30	7,6	1.73	43,9	
		13	M4524GBG	LTCG 1-1/4		cRU/US	1.680	42,7	2.69	68,3	.78	19,8	.30	7,6	2.05	52,1
5,2	USE-2	2	M3231GAE	LTCG 1/2	UL/CSA	.875	22,2	1.70	43,2	.61	15,5	.21	5,3	.98	24,9	
		3	M3234GAF	LTCG 3/4		UL/CSA	1.040	26,4	2.00	50,8	.62	15,7	.25	6,4	1.30	33,0
		4	M3234GAG													
5,6	USE-2	3	M3200GAH	LTCG LL 1/2	UL/CSA	.875	22,2	1.68	42,7	.44	11,2	.25	6,4	1.06	27,0	
Skinned-Over Break-thru Solar Masthead Gland - Assembled Metal Locknuts INCLUDED																
5,5	USE-2	5	M3234GBR-SM	SMCG 3/4	cRU/US	1.040	26,4	2.00	50,8	.62	15,7	.25	6,4	1.30	33,0	
		9	M8437GBK-SM	SMCG 1		cRU/US	1.326	33,8	2.41	61,2	.76	19,3	.30	7,6	1.73	43,9
		13	M4524GBM-SM	SMCG 1-1/4		cRU/US	1.680	42,7	2.69	68,3	.78	19,8	.30	7,6	2.05	52,1
		21	M3317GBQ-SM	SMCG 1-1/2		cRU/US	1.920	48,8	2.81	71,4	.76	19,3	.36	9,1	2.48	63,0
		31	M3321GBY-SM	SMCG 2		cRU/US	2.400	60,8	2.92	74,2	.79	20,1	.42	10,7	2.73	69,3
5,6	USE-2	3	M3200GAH-SM	SMCG LL 1/2	UL/CSA	.875	22,2	1.68	42,7	.44	11,2	.25	6,4	1.06	27,0	
7,7	PV 1000 or USE-2**	3	M3234GBS-SM	SMCG 3/4	UL/CSA	1.040	26,4	2.00	50,8	.62	15,7	.25	6,4	1.30	33,0	
		5	M8437GBT-SM	SMCG 1		UL/CSA	1.326	33,8	2.41	61,2	.76	19,3	.30	7,6	1.73	43,9
		9	M4524GBW-SM	SMCG 1-1/4		UL/CSA	1.680	42,7	2.69	68,3	.78	19,8	.30	7,6	2.05	52,1
		11	M3317GBZ-SM	SMCG 1-1/2		cRU/US	1.920	48,8	2.81	71,4	.76	19,3	.36	9,1	2.48	63,0
8,9	PV 1000	19	M3321GBX-SM	SMCG 2	UL/CSA	2.400	60,8	2.92	74,2	.79	20,1	.42	10,7	2.73	69,3	
		7	M4524GCJ-SM	SMCG 1-1/4	UL/CSA	1.680	42,7	2.69	68,3	.78	19,8	.30	7,6	2.05	52,1	
		9	M3317GCK-SM	SMCG 1-1/2	cRU/US	1.920	48,8	2.81	71,3	.76	19,3	.36	9,1	2.48	63,0	
7,4	PV 1000	12	M3321GCM-SM	SMCG 2	UL/CSA	2.400	60,8	2.93	74,3	.79	20,1	.42	10,7	2.75	69,9	
		Other Configurations with Approval Potential - Locknuts not included														
6,0	***	2	M3200GAJ	LTCG LL 1/2	-	.875	22,2	1.68	42,7	.44	11,2	.25	6,4	1.06	27,0	
		4	M3234GBC	LTCG 3/4	-	1.040	26,4	2.00	50,8	.62	15,7	.25	6,4	1.30	33,0	
6,5	***	6	M8437GAL	LTCG 1	-	1.326	33,8	2.41	61,2	.76	19,3	.30	7,6	1.73	43,9	
			M4524GAL	LTCG 1-1/4	-	1.680	42,7	2.69	68,3	.78	19,8	.30	7,6	2.05	52,1	
7,0	PV 1000	3	M3234GAM	LTCG 3/4	-	1.040	26,4	2.00	50,8	.62	15,7	.25	6,4	1.30	33,0	
7,4	PV 1000	2	M3234GAN													

*AWG 10 and 12 for both USE-2 and PV 1000 except 4,5 mm Conductors Recognized for AWG 12 only.

**8 AWG USE-2 Wire

***Depends on actual wire: 10 AWG USE-2 or 12 AWG PV 1000.



Use Heyco Multi-Hole Cordgrips with Heyco Female Threaded Couplings and Heyco-Flex III Tubing to insulate exposed PV wiring when making complete liquid tight connections to solar combiner or inverter enclosures. **See page 2-1 for details.**

Quick Specs

Material	Nylon 6/6 with TPE sealing gland
Certifications	<ul style="list-style-type: none"> UL Listed under Underwriters' Laboratories File E51579 cRU/US Recognized under the Component Program of Underwriters' Laboratories File E51579 to both Canadian and U.S. requirements CSA Certified by the Canadian Standards Association File 93876
Flammability Rating	94-V2
Temperature Range	Static -40°F (-40°C) to 239°F (112°C) Dynamic -4°F (-20°C) to 212°F (100°C)
IP Rating	IP 68

“Stay Connected” with



Solar Power Components

a PennEngineering® Company

“Coined” edges prevent cable damage

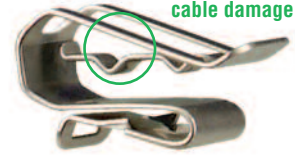

HEYClip™ SunRunner® Cable Clips

Double-Compression, Straight-thru Design

PANEL THICKNESS CLAMPING RANGE				WIRE DIA. RANGE	PART NO.		DESCRIPTION	FOOTPRINT		OVERALL HEIGHT	
Minimum		Maximum			304	316		A x B		C	
in.	mm.	in.	mm.		Stainless	Stainless	in.	mm.	in.	mm.	
1-2 Wires - SunRunner Clip for panels up to .090" (2,3 mm) thick											
.06	1,4	.09	2,3	.20" (5,1 mm)- .33" (8,3 mm) each cable	S6405	S6490	SunRunner® Clip 100 Pack	.97 x .50	24,6 x 12,7	.39	9,9
					S6445	S6495	SunRunner® Clip Bulk				
1-2 Wires - SunRunner Vidrio™ Clip for GLASS panels up to .090" (2,3 mm) thick NEW PRODUCTS											
.13	3,2	.25	6,4	.20" (5,1 mm)- .33" (8,3 mm) each cable	S6460	-	SunRunner® Vidrio™ Clip 100 Pack	.99 x .52	25,1 x 13,2	.45	11,4
					S6500	-	SunRunner® Vidrio™ Clip Bulk				
1-2 Wires - SunRunner EZ Clip for panels up to .250" (6,4 mm) thick											
.09	2,3	.25	6,4	.20" (5,1 mm)- .33" (8,3 mm) each cable	S6407	-	SunRunner® EZ Clip 100 Pack	.97 x .50	24,6 x 12,7	.41	10,4
					S6447	-	SunRunner® EZ Clip Bulk				
4 Wires - SunRunner 4 Clip for panels up to .125" (3,2 mm) thick											
.06	1,4	.13	3,2	.20" (5,1 mm)- .30" (7,6 mm) each cable*	S6443	-	SunRunner® 4 Clip 100 Pack	1,34 x .50	33,8 x 12,7	.36	9,1
					S6483	-	SunRunner® 4 Clip Bulk				
4 Wires - SunRunner 4 EZ Clip for panels up to .250" (6,4 mm) thick											
.13	3,2	.25	6,4	.20" (5,1 mm)- .30" (7,6 mm) each cable*	S6400	-	SunRunner® 4 EZ Clip 100 Pack	1,33 x .50	33,8 x 12,7	.36	9,1
					S6440	-	SunRunner® 4 EZ Clip Bulk				

*Can accommodate up to three .33" (8,3 mm) diameter cables.

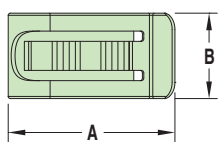

SunRunner®

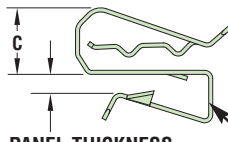

Wide, Flat Section for "EZ" Assembly

SunRunner® EZ

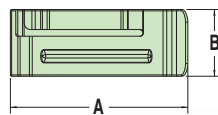

SunRunner® 4



SunRunner® 4 EZ



SunRunner® EZ with (optional) UL Approved SunBundler (page 1-11) looped through slot



SunRunner® Vidrio™

Material	.025" thick 304 or 316 stainless steel (SunRunner and SunRunner EZ) .020" thick 410 stainless steel (SunRunner 4 and SunRunner 4 EZ)
Certifications	Certified by UL for Compliance with both Canadian and US Requirements under File E54523
Temperature Range	-40°F (-40°C) to 572°F (300°C)

- Heyco's SunRunner and SunRunner EZ's robust "double-compression" design securely holds from (1) 12 gauge USE-2 to (2) 10 gauge PV-1000V solar wires.
- Also for use with other cables from .20" (5,1 mm) to .33" (8,3 mm) in diameter.
- Heyco SunRunner Clips are designed to provide a better method for PV module wire management **and may be used wherever single or multiple cable management is needed.**
- Smooth clip edges prevent damage to cable insulation.
- Locking tabs securely fasten clips to module extrusions, **or other panels.**
- Screwdriver slot for easy removal or movement of clips if necessary.
- Neatly dresses cables on PV panel frames or along mounting channels.
- Constructed from corrosion resistant 304 stainless steel, not for use in a marine salt water environment.
- 316 stainless steel now available for marine and other harsh environments.
- **SunRunner Vidrio™ is designed to mount directly onto the glass panel with compression force only.** Will not harm the glass surface, and the black color meets many HOA requirements!
- The TPE coating on the SunRunner Vidrio™ provides an electrically insulated surface.
- **SunRunner EZ's are designed for thicker module frames** as well as racking – accommodates profiles up to .250" (6,4 mm) thick!
- **SunRunner 4 designed to hold up to (4) 12 gauge USE-2 or (4) 10 gauge PV-1000V solar wires.**
- SunRunner 4 is constructed from heat treated 410 stainless steel for excellent strength and corrosion protection for outdoor exposure.
- DFARS Compliant.



“Stay Connected” with



Solar Power Components

a PennEngineering® Company



- SunRunner 90° Cable Clips are designed to mount at a 90° angle to the original SunRunner®.
- The SunRunner 90° will accommodate a single cable from .20" (5,1 mm) to .33" (8,3 mm); SunRunner 90-2 will accommodate (2) of these cables; SunRunner 4 will accommodate (4) cables from .30" (7,6 mm) to .20" (5,1 mm).
- SunRunner 90° Series is designed for use with PV modules mounted in the “landscape” mode. PV modules with shorter than normal junction box cables cannot be dressed out to the sides of the module. The SunRunner 90° Series will also allow the junction box cables to be run to the adjacent modules across the short side of the PV module frame.
- Not for use in a marine salt water environment. Contact Heyco for alternative materials.
- DFARS Compliant.

HEYClip™ SunRunner® 90° Cable Clips

Double-Compression, Right Angle Design

PANEL THICKNESS CLAMPING RANGE				WIRE DIA. RANGE Maximum	PART NO.	DESCRIPTION	FOOTPRINT		OVERALL HEIGHT	
Minimum		Maximum					A x B		C	
in.	mm.	in.	mm.				in.	mm.	in.	mm.
Single Wire Clip for panels up to .125" (3,2 mm) thick										
.06	1,4	.13	3,2	.20" (5,1 mm)- .33" (8,3 mm) each cable	S6406	SunRunner® 90° Clip 100 Pack	.82 x .78	20,8 x 19,8	.39	9,9
					S6446	SunRunner 90° Clip Bulk				
Double Wire Clip for panels up to .125" (3,2 mm) thick NEW PRODUCTS										
.06	1,4	.13	3,2	.20" (5,1 mm)- .33" (8,3 mm) each cable	S6436	SunRunner® 90°-2 Clip 100 Pack	.65 x .98	16,5 x 24,9	.39	9,9
					S6476	SunRunner® 90°-2 Clip Bulk				
Four Wire Clip for panels up to .125" (3,2 mm) thick NEW PRODUCTS										
.06	1,4	.13	3,2	.20" (5,1 mm)- .30" (7,6 mm) each cable*	S6439**	SunRunner® 90°-4 Clip 100 Pack	.56 x 1.63	14,2 x 41,4	.36	9,1
					S6479**	SunRunner® 90°-4 Clip Bulk				

*Can accommodate up to three .33" (8,3 mm) diameter cables.

**SunRunner 90-4 parts are not cULus

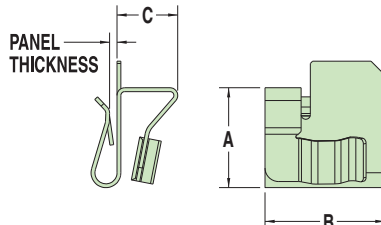

SunRunner® 90°

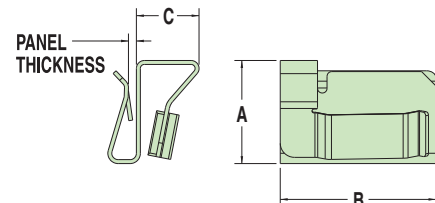

SunRunner® 90-2

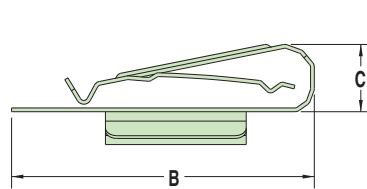

SunRunner® 90-4

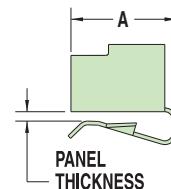

Quick
Specs

Material .020" thick heat treated 410 stainless steel (SunRunner 90-4)
.025" thick 304 stainless steel (SunRunner 90° and SunRunner 90-2)
Certifications Certified by UL for Compliance with both Canadian and US Requirements under File E54523

“Stay Connected” with



Solar Power Components

a PennEngineering® Company

ALL NEW PRODUCTS!

HEYClip™ Stainless Steel SunRunner® 2-S Series Cable Clips

For Rail-less Systems

PANEL THICKNESS CLAMPING RANGE				WIRE DIA. RANGE		PART NO.	DESCRIPTION	FOOTPRINT A x B		REAR TAB LENGTH	
Minimum		Maximum		in.	mm.			in.	mm.	in.	mm.
in.	mm.	in.	mm.								
SunRunner 2-S											
.05	1,3	.12	3,0	.30 - .47	7,6-12,0	S6448	SunRunner 2-S 100 Pack	1.14 x .50	29,0 x 12,7	.68	17,3
						S6488	SunRunner 2-S Bulk				
SunRunner 2-S-EZ											
.12	3,0	.25	6,4	.30 - .47	7,6-12,0	S6449	SunRunner 2-S-EZ 100 Pack	1.14 x .50	29,0 x 12,7	.68	17,3
						S6489	SunRunner 2-S-EZ Bulk				

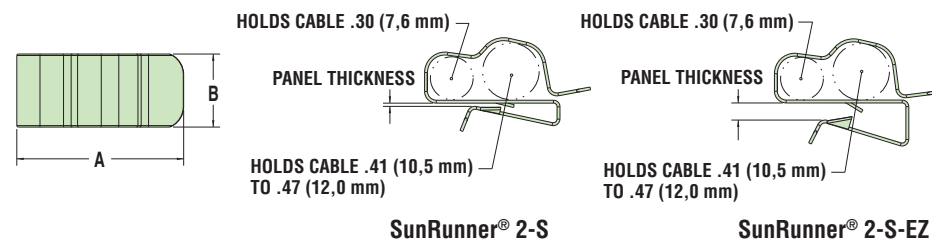

HEYClip™ SunRunner® CT Cable Tie Mounting Platforms

Stainless Steel Edge Clip

MAX CABLE TIE WIDTH		PANEL THICKNESS CLAMPING RANGE				INSERT POINTS	PART NO.	DESCRIPTION	FOOTPRINT A x B		REAR TAB LENGTH	
Minimum		Maximum		in.	mm.				in.	mm.	in.	mm.
in.	mm.	in.	mm.			in.	mm.					
SunRunner CT												
.31	8,0	.06	1,5	.12	3,0	4	S6434	SunRunner CT 100 Pack	1.05 x .63	26,7 x 16,0	.77	19,5
							S6474	SunRunner CT Bulk				
SunRunner CT-EZ												
.31	8,0	.12	3,0	.25	6,4	4	S6435	SunRunner CT-EZ 100 Pack	1.06 x .63	26,9 x 16,0	.77	19,5
							S6475	SunRunner CT-EZ Bulk				

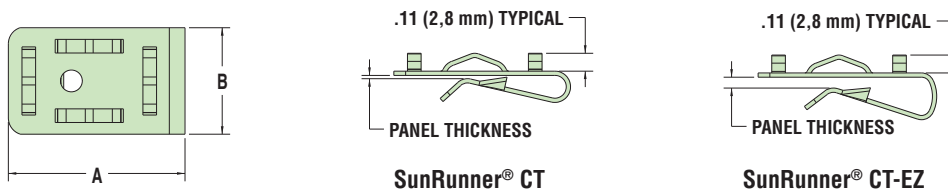

Material .020" thick heat treated 410 stainless steel (2-S & 2-S-EZ)
.025" Thick 304 stainless steel (CT & CT-EZ)

Certifications Certified by UL for Compliance with both Canadian and US Requirements under File E54523



- Designed to hold Micro-Inverter Cables .413" (10,5 mm) to .472" (12,0 mm) and Module Cables up to .300" (7,6 mm) in diameter for rail-less mounting systems.
- Constructed from heat treated 410 stainless steel for excellent strength and corrosion protection for outdoor exposure.
- Smooth clip edges prevent damage to cable installation.
- Designed for panel and cable retention up to 15 lbs.
- Neatly dress cables on PV panels or module frames from .050" (1,3 mm) to .250" (6,4 mm) thick.



- Designed to easily mount to module or frame extrusions without the need for mounting holes or adhesives.
- Designed to be used with Heyco Stainless Steel Cable Ties up to .31" (8,0 mm) width or Heyco SunBundler Stainless Steel Wire Cable Ties.
- Hold cable bundles parallel or perpendicular to the mounting frame.
- Generous lead-in for installation without tools.
- Constructed from corrosion resistant 304 stainless steel.
- SunRunner CT-EZ designed for thicker module frames as well as racking systems - accommodates profiles up to .250" (6,4 mm) thick.
- UL Listed per UL 1565.

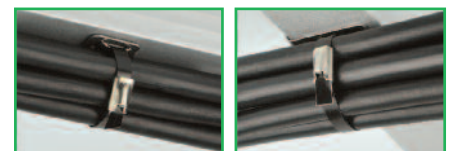

Mount Parallel or Perpendicular



HEYClip™ Stainless Steel SunRunner® 2 Series Cable Clips for Micro-Inverter Cables

- **Designed to hold Micro-Inverter cables** .413" (10,5 mm) to .472" (12,0 mm) in diameter.
- Constructed from heat treated 410 stainless steel for excellent strength and corrosion protection for outdoor exposure.
- Smooth clip edges prevent damage to cable insulation.
- “S” hook clip design will fit a wide variety of extruded aluminum profiles.
- **SunRunner 2** is designed for solar mounting frames such as the ones used by Unirac, Solar Mount and Mounting Systems.
- **SunRunner 2-R** is designed for racking systems such as the ones used by Haticon Solar and S:FLEX.
- **SunRunner 2-U** features a shorter S hook for Unirac and other similar frame profiles.
- Neatly dresses cable on PV panels or along mounting frame channels from .080" (2,0 mm) to .250" (6,4 mm) thick.
- See page 1-9 for typical rack profile applications.
- Not for use in a marine salt water environment. Contact Heyco for alternative materials.
- DFARS Compliant

PANEL THICKNESS CLAMPING RANGE		WIRE DIA. RANGE		PART NO.	DESCRIPTION	FOOTPRINT		REAR TAB LENGTH			
Minimum	Maximum	in.	mm.			in.	mm.	in.	mm.		
SunRunner® 2											
.08	2,0	.25	6,4	.30 - .47	7,6-12,0	S6404	SunRunner® 2 100 Pack	.50 x 1.30	12,7 x 33,0	.84	21,3
SunRunner® 2-R											
.38	9,7	.38	9,7	.30 - .47	7,6-12,0	S6402	SunRunner® 2-R 100 Pack	.50 x 1.30	12,7 x 33,0	.41	10,4
SunRunner® 2-U											
.25	6,4	.25	6,4	.30 - .47	7,6-12,0	S6401	SunRunner® 2-U 100 Pack	.50 x 1.30	12,7 x 33,0	.38	9,7



SunRunner 2



SunRunner 2-R



SunRunner 2-U

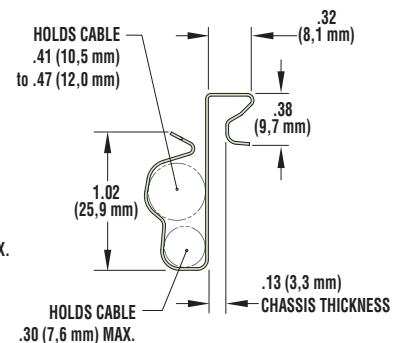
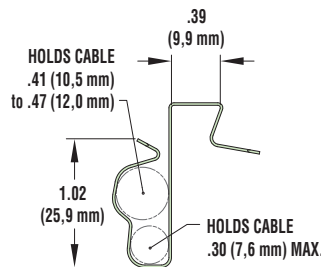
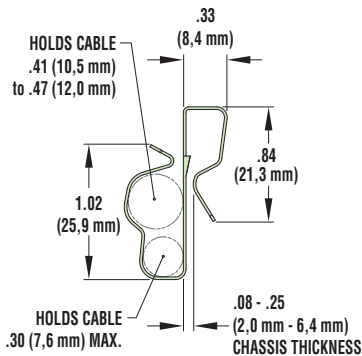
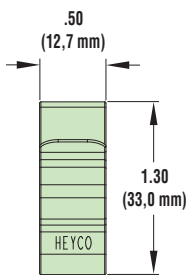

Quick Specs

Material .020" thick heat treated 410 stainless steel

“Stay Connected” with



Solar Power Components

a PennEngineering® Company

HEYClip™ Nylon UVX* SunRunner® 2 Series Cable Clips for Micro-Inverter Cables

*Extended UV Protection

PANEL THICKNESS CLAMPING RANGE				WIRE DIA. RANGE		PART NO.	DESCRIPTION	FOOTPRINT		REAR TAB LENGTH	
Minimum		Maximum		in.	mm.			in.	mm.	in.	mm.
in.	mm.	in.	mm.								
SunRunner 2 UVX											
.08	2,0	.25	6,4	.30 - .47	7,6-12,0	S6463	SunRunner 2 UVX 100 Pack	.50 x 1.44	12,7 x 36,6	.94	23,9
						S6473	SunRunner 2 UVX Bulk				
SunRunner 2-R UVX											
.38	9,7	.38	9,7	.30 - .47	7,6-12,0	S6462	SunRunner 2-R UVX 100 Pack	.50 x 1.44	12,7 x 36,6	.56	14,2
						S6472	SunRunner 2-R UVX Bulk				
SunRunner 2-U UVX											
.25	6,4	.25	6,4	.30 - .47	7,6-12,0	S6461	SunRunner 2-U UVX 100 Pack	.50 x 1.44	12,7 x 36,6	.53	13,5
						S6471	SunRunner 2-U UVX Bulk				



- Designed to hold Micro-Inverter cables .413" to .472" (10,5 to 12,0 mm) in diameter.
- Constructed from extended protection nylon UV material for **lower cost**, excellent strength, and corrosion protection from outdoor exposure.
- Smooth clip edges prevent damage to cable insulation.
- “S” hook clip design will fit a wide variety of extruded aluminum profiles.
- **SunRunner 2 UVX** is designed for solar mounting frames such as the ones used by Unirac, Solar Mount and Mounting Systems.
- **SunRunner 2-R UVX** is designed for racking systems such as the ones used by Haticon Solar and S:FLEX.
- **SunRunner 2-U UVX** features a shorter “S” hook for Unirac and other similar frame profiles.
- Neatly dresses cables on PV panels or along mounting frame channels from .080" (2,0 mm) to .250" (6,4 mm) thick.
- Molded from UV/Heat Stabilized Nylon.
- See page 1-9 for typical rack profile applications.



SunRunner 2 UVX



SunRunner 2-R UVX



SunRunner 2-U UVX

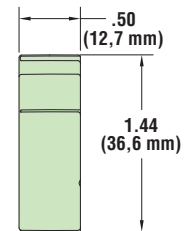
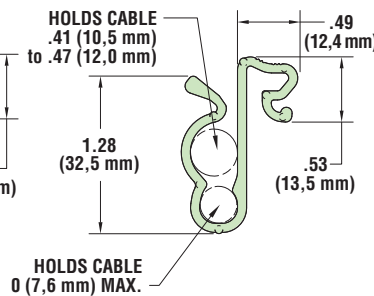
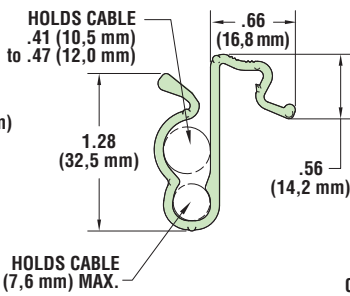
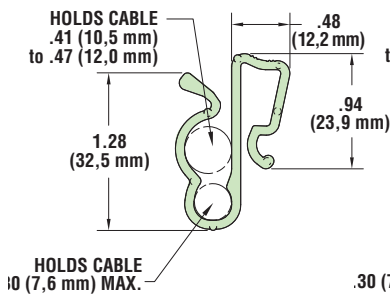

Material: Nylon 6/6 with extended UV capabilities
 Flammability Rating: 94V-2
 Temperature Range: -4°F (-18°C) to 185°F (85°C)

Quick Specs

“Stay Connected” with



Solar Power Components

a PennEngineering® Company

HEYClip™ Stainless Steel and Nylon UVX SunRunner® 2 Series Cable Clips for Micro-Inverter Cables (Stainless Steel shown below)

“Where Used” Rack Profiles

SunRunner 2
fits Everest, SnapNrack,
and similar rack profiles

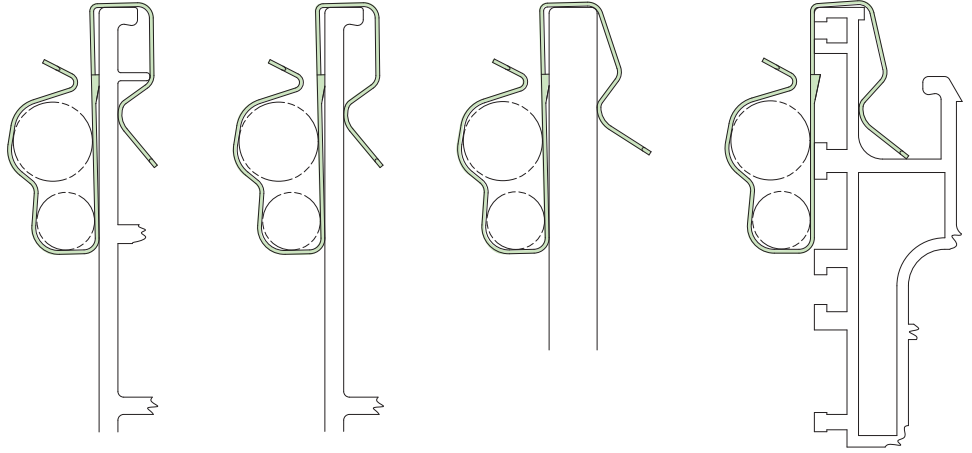

Consult Heyco
for clips to meet
your specific
rack profile

SunRunner 2-R
fits Haticon Solar, S:FLEX
and similar rack profiles

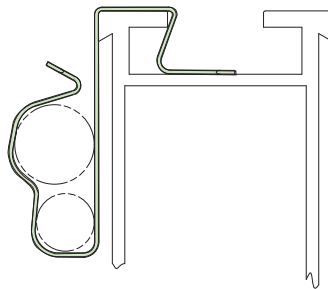

SunRunner 2-U
fits Unirac Solar Mount
Standard Rail and similar
rack profiles

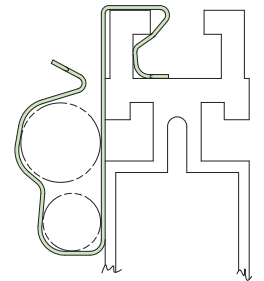

- This vinyl coated spring steel clamp secures round cable, ribbon cable, and tubing.
- Vinyl coating protects and insulates.
- Mounts with a #6 (M3,5) screw, yet cable can be inserted and removed without removing the clip.

**ALL NEW
PRODUCT!**

HEYClip™ Vinyl Coated Spring Clamps

PART NO.	DESCRIPTION	PART DIMENSIONS							
		A Length		B Clamping Height		C Clamping Length		D Mounting Hole	
		in.	mm.	in.	mm.	in.	mm.	in.	mm.
12710	VCSP-161-09	1.61	40,9	.09	2,3	1.19	30,2	.156	4,0
12711	VCSP-263-09	2.63	66,8	.09	2,3	2.24	56,9		

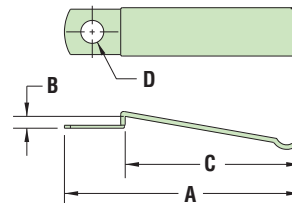

*Quick
Specs*

Material VCSP Body: Stainless steel, w/vinyl coating .02" (0,5 mm) thick
Coating: Soft, PVC, .032" (0,8 mm) minimum thickness

“Stay Connected” with



Solar Power Components

a PennEngineering® Company

HEYClip™ MaxRunner® Cable Clip Arrays

Clip Mount or Flush Mount with Screws*, accommodates up to **12 Cables**

PANEL THICKNESS CLAMPING RANGE		WIRE DIA. RANGE		PART NO.	DESCRIPTION	FOOTPRINT		OVERALL HEIGHT			
Minimum	Maximum	Maximum (12) Wires				in.	mm.	in.	mm.		
.06	1,5	.25	6,4	.20 - .28	5,2 - 7,2	S6403	MaxRunner 12 Clip Mount	3.00 x 3.13	76,2 - 79,5	.98	24,9
Flush Mount											
N/A: designed for flat mount				.20 - .28	5,2 - 7,2	S6433	MaxRunner 12 Flush Mount	3.00 x 3.13	76,2 - 79,5	1.00	25,4

*Screws not included



- Hold up to 12 cables with wire diameters ranging from .20" (5,2 mm) to .28" (7,2 mm).
- Patent Pending design is the ultimate in solar wire management.
- Molded internal locking tabs securely hold the cables in place **preventing side-to-side movement or slippage** of the cables.
- Constructed from PPE+PS flame retardant "Noryl" material with a **V-0 flame rating** and a **UV (f1) rating** for excellent resistance to outdoor exposure.
- **Clip Mount** features a versatile, 301 stainless steel mounting clip.
- Clip is designed to secure the holder to a wide variety of aluminum extruded mounting rails of various profiles with thicknesses up to .250" (6,4 mm).
- **Flush Mount** designed to mount on flat panels or extrusions without mounting ledges.
- Easily attaches to any flat surface with four mounting screws.
- Recommended spacing is 4 feet.
- Load Rating not to exceed 15 lbs.
- US Patent No. 8950712B2

Clip Mount

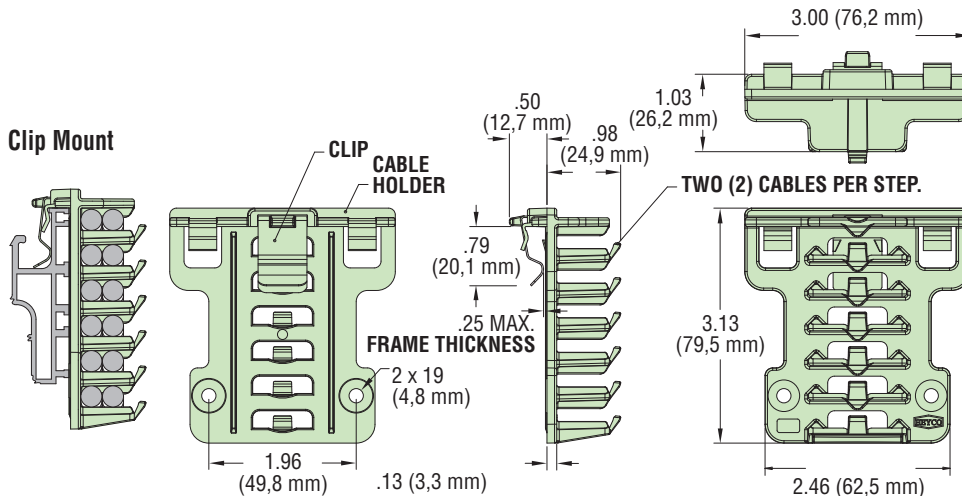

Flush Mount

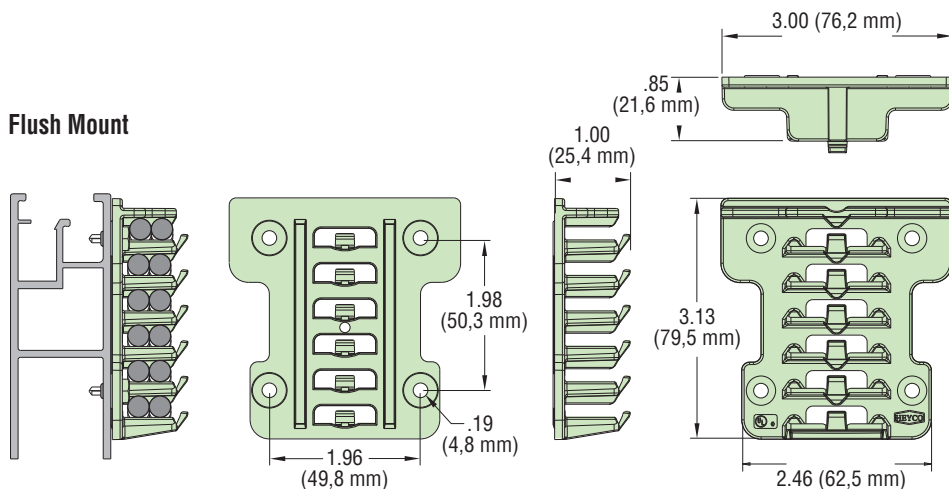

Materials
Certifications



PPE & PS Noryl (Clipmount includes a 301 stainless steel mounting clip)
Certified by UL for Compliance with both Canadian and U.S. requirements under File E54523

Flammability Rating
Temperature Range

94V-0
-40°F (-40°C) to 203°F (95°C)

Quick Specs

“Stay Connected” with



Solar Power Components

a PennEngineering® Company



- Feature metal pawl for high strength and better durability.
- Self-locking head design speeds installation and locks into place at any length along the tie body.
- Provide a strong, durable method of cable bundling.
- Can be used in a wide range of indoor, outdoor, and underground (including direct burial) applications.
- Smooth surfaces and rounded edges assure cable protection and worker safety.
- Part Description Key: NTMP-XXX-YYY where XXX = tensile (foot pounds) and YYY = length (inches x 10).
- These parts are not covered under Heyco’s solar warranty.

Heyco® Nytyes® with Stainless Steel Locking Device

PART SPECIFICATIONS				PART NO.		DESCRIPTION	PART DIMENSIONS					
Min. Tensile Strength		Max. Bundle Diameter		Natural	Black		A Length		B Width		C Thickness	
Lbs.	N	in.	mm.			in.	mm.	in.	mm.	in.	mm.	
18	80	.87	22,0	13000	13000B	NTMP-018-039	3.90	100	.12	3,0	.04	1,1
35	160	1.42	36,0	13001	13001B	NTMP-036-059	5.90	150	.16	4,0	.05	1,2
		2.09	53,0	13002	13002B	NTMP-036-079	7.90	200				
45	200	2.56	65,0	13003	13003B	NTMP-045-098	9.80	250	.20	5,0		
		2.99	76,0	13004	13004B	NTMP-045-118	11.80	300				
56	250	2.09	53,0	13008	13008B	NTMP-056-079	7.90	200	.31	8,0	.06	1,5
		2.60	66,0	13009	13009B	NTMP-056-094	9.40	240				
		2.99	76,0	13010	13010B	NTMP-056-118	11.80	300				
112	500	2.99	76,0	13011	13011B	NTMP-112-118	11.80	300	.39	10,0	.07	1,7
		3.74	95,0	13012	13012B	NTMP-112-138	13.80	350				
		4.45	113,0	13013	13013B	NTMP-112-157	15.70	400				
124	550	4.72	120,0	13014	13014B	NTMP-124-177	17.70	450				
		6.22	158,0	13015	13015B	NTMP-124-197	19.70	500				

Standard colors natural and UV Black.

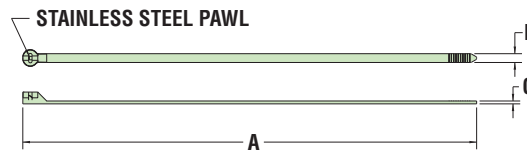

Material Nylon 6/6 wire tie with a stainless steel locking pawl
 Flammability Rating 94V-2
 Temperature Range -40°F (-40°C) to 185°F (85°C)

For Heyco's complete line of Nylon Cable Ties & Platforms, see pages 7-64 thru 7-69



- **Extremely durable, vinyl jacketed Stainless Steel Cable Tie.**
- Smooth vinyl jacketing prevents damage to installation cable insulation.
- Stainless steel crimp sleeve for easy field installation with electrician linesman pliers, or wire cutters.
- **Certified by UL Specification 62275 for indoor and outdoor usage.**
- UV protected vinyl jacket is excellent for solar installation where product durability is required.
- Use standard wire cutters to both crimp the sleeve and cut the excess wire.
- Not for use in a marine salt water environment. Contact Heyco for alternative materials.
- DFARS Compliant.

Heyco® SunBundler®

Crimp Lock PVC Coated Stainless Steel Wire Cable Ties



PART SPECIFICATIONS				PART NO.		DESCRIPTION	PART DIMENSIONS			
Max. Tensile Strength		Max. Bundle Diameter		100 Pack	Bulk		A Length		B Diameter	
Lbs.	N	in.	mm.			in.	mm.	in.	mm.	
Black vinyl jacketed 302/304 stainless steel wire										
100	440	2.30	58,4	S6408	S6409	SunBundler® 8	8	203	.06	1,6
		2.92	74,2	S6410	S6411	SunBundler® 10	10	254		
		3.88	98,6	S6412	S6413	SunBundler® 12	12	305		
		4.20	106,7	S6414	S6415	SunBundler® 14	14	356		
		6.36	161,5	S6420	S6421	SunBundler® 20	20	508		

Standard color Black.

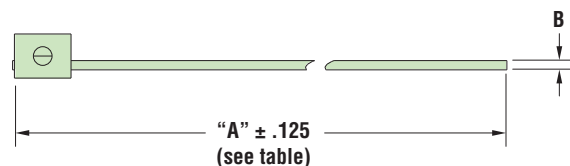

Material Commercial Aircraft Grade 302/304 stainless wire w/UV protected vinyl jacket
 Certifications Certified by Underwriters' Laboratories for Compliance to both Canadian and U.S. Requirements under File E54523
 Temperature Range -40°F (-40°C) to 221°F (105°C)

For Heyco's complete line of Nylon Cable Ties & Platforms, see pages 7-64 thru 7-69

Heyco® Stainless Steel Cable Ties

Ball Lock Stainless Steel Strip Cable Ties – Standard and PVC Coated

PART SPECIFICATIONS				PART NO.		DESCRIPTION	PART DIMENSIONS			
Min. Tensile Strength		Max. Bundle Diameter		Standard Steel	PVC Coated Black		A Length		B Width	
Lbs.	N	in.	mm.			in.	mm.	in.	mm.	
AISI 304										
112	500	1.18	30,0	12801	12801B	NTSS-0150-46A	5.91	150,0	.18	4,6
		2.05	52,0	12802	12802B	NTSS-0200-46A	7.87	200,0		
		2.68	68,0	12803	12803B	NTSS-0250-46A	9.84	250,0		
		3.23	82,0	12805	12805B	NTSS-0300-46A	11.81	300,0		
		3.86	98,0	12806	12806B	NTSS-0350-46A	13.78	350,0		
		4.33	110,0	12808	12808B	NTSS-0400-46A	15.75	400,0		
		5.75	146,0	12810	12810B	NTSS-0500-46A	19.69	500,0		
		7.09	180,0	12812	12812B	NTSS-0600-46A	23.62	600,0		
9.50	240,0	12814	12814B	NTSS-0800-46A	31.50	800,0				
250	1115	2.05	52,0	12821	12821B	NTSS-0200-79A	7.87	200,0	.31	7,9
		2.68	68,0	12822	12822B	NTSS-0250-79A	9.84	250,0		
		3.23	82,0	12824	12824B	NTSS-0300-79A	11.81	300,0		
		3.86	98,0	12825	12825B	NTSS-0350-79A	13.78	350,0		
		4.33	110,0	12827	12827B	NTSS-0400-79A	15.75	400,0		
		5.75	146,0	12829	12829B	NTSS-0500-79A	19.69	500,0		
		7.09	180,0	12831	12831B	NTSS-0600-79A	23.62	600,0		
		8.27	210,0	12833	12833B	NTSS-0700-79A	27.56	700,0		
		9.50	240,0	12834	12834B	NTSS-0800-79A	31.50	800,0		
		12.09	307,0	12836	12836B	NTSS-1000-79A	39.37	1000,0		
AISI 316										
112	500	1.18	30,0	12851	12851B	NTSS-0150-46B	5.91	150,0	.18	4,6
		2.05	52,0	12852	12852B	NTSS-0200-46B	7.87	200,0		
		2.68	68,0	12853	12853B	NTSS-0250-46B	9.84	250,0		
		3.23	82,0	12855	12855B	NTSS-0300-46B	11.81	300,0		
		3.86	98,0	12856	12856B	NTSS-0350-46B	13.78	350,0		
		4.33	110,0	12858	12858B	NTSS-0400-46B	15.75	400,0		
		5.75	146,0	12860	12860B	NTSS-0500-46B	19.69	500,0		
		7.09	180,0	12862	12862B	NTSS-0600-46B	23.62	600,0		
9.50	240,0	12864	12864B	NTSS-0800-46B	31.50	800,0				
250	1115	2.05	52,0	12871	12871B	NTSS-0200-79B	7.87	200,0	.31	7,9
		2.68	68,0	12872	12872B	NTSS-0250-79B	9.84	250,0		
		3.23	82,0	12874	12874B	NTSS-0300-79B	11.81	300,0		
		3.86	98,0	12875	12875B	NTSS-0350-79B	13.78	350,0		
		4.33	110,0	12877	12877B	NTSS-0400-79B	15.75	400,0		
		5.75	146,0	12879	12879B	NTSS-0500-79B	19.69	500,0		
		7.09	180,0	12881	12881B	NTSS-0600-79B	23.62	600,0		
		8.27	210,0	12883	12883B	NTSS-0700-79B	27.56	700,0		
		9.50	240,0	12884	12884B	NTSS-0800-79B	31.50	800,0		
		12.09	307,0	12886	12886B	NTSS-1000-79B	39.37	1000,0		

NEW PRODUCT



- For ease of assembly, position locking head so that the widest end is down.
- Part Description Key: NTSS-XXXX-YYA where XXXX = length (mm) and YYA = width (mm) with A indicating AISI 304 stainless steel and B indicating AISI 316 stainless steel.
- Stainless steel cable ties have more strength and better durability than nylon cable ties.
- Locking ball design for maximum holding strength and ease of installation.
- Coated ties offer additional protection and separation of dissimilar metals for improved corrosion resistance.
- Suitable for harsh outdoor environments; conform to standard IEC92 for Marine Electrical Appliances and the requirements of CB1113-85 “Plastic Covered Metal Cable Ties”, “Steel Sea Boats Construction Level Standard.”
- Secure bundles in moist and high temperature environments with decay, fire, corrosion, and radio resistance.
- Widely used in shipping, communication, and flight applications.
- .010" (0,25 mm) thick.
- Custom lengths available.
- 100 pack standard.



For SunRunner CT Mounting Platform details, see page 1-6.

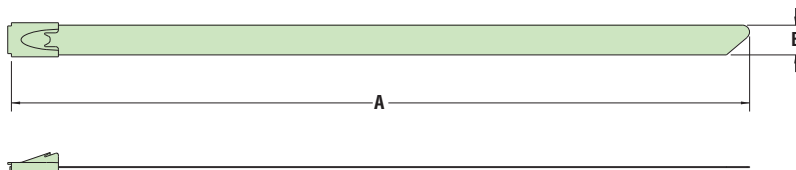

Materials

AISI 304 or 316 stainless steel with PVC coating

Quick Specs

“Stay Connected” with



Solar Power Components

a PennEngineering® Company



Heyco® Edge Clips

Edge Clips Unassembled or Assembled with 8" Cable Tie

- Ideal for use where holes cannot be used or where adhesives are unacceptable due to temperature issues.
- Applies easily to plastic and metal without the need for a mounting hole.
- Ideal for assembly usage. Clip provides low insertion force and high extraction.
- Two piece assembly allows the clip to slide along the strap ensuring proper orientation.
- For Acetal Cable ties add “A” to the Assembled Part No.; eg 14275A.

UNASSEMBLED EDGE CLIP			EDGE CLIP ASSEMBLED WITH CABLE TIE			ASSEMBLED NYTYE CABLE TIE					
Fixing	Part No. Black	Desc.	Cable Tie Orientation	Part No. Black	Description	Tensile Strength		Max. Bundle Diameter		Overall Length	
						Lbs.	N	in.	mm.	in.	mm.
For Panels from .04" (1,0 mm) to .12" (3,0 mm) Thick											
Top	14267	NTEC1-TB	Perpendicular	14275	NTEC1-TP-50-078	50	222	1.77	45,0	7.87	200
			Parallel		14276						
Side	14268	NTEC1-SB	Perpendicular	14277	NTEC1-SP-50-078						
			Parallel		14278						
For Panels from .12" (3,0 mm) to .24" (6,0 mm) Thick											
Top	14270	NTEC2-TP	Perpendicular	14280	NTEC2-TP-50-078	50	222	1.77	45,0	7.87	200
			Parallel		14281						
Side	14272	NTEC2-SP	Perpendicular	14282	NTEC2-SP-50-078						
			Parallel		14283						

Standard color black.

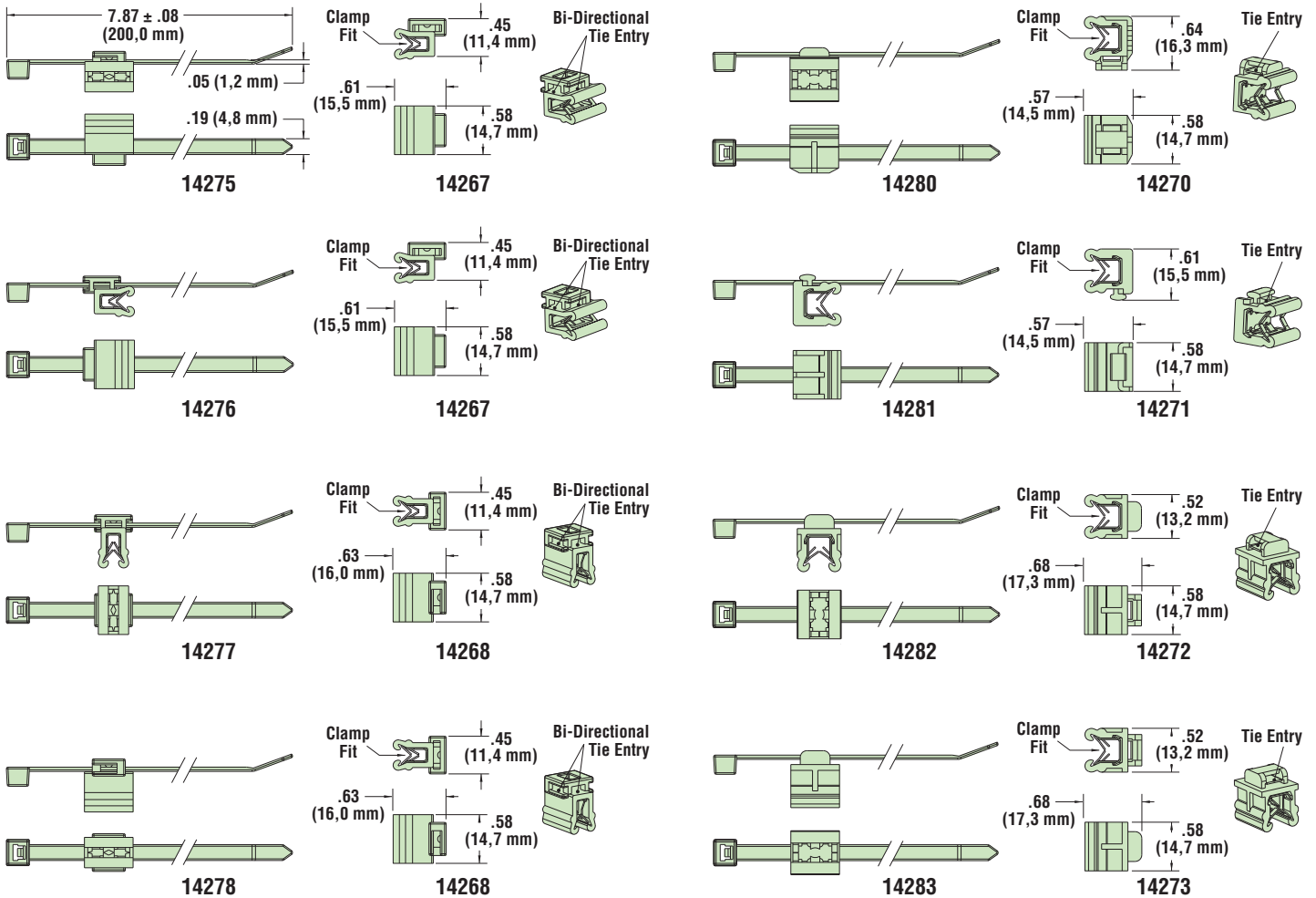

Material Nylon 6/6 high impact modified, heat and UV stabilized
 Flammability Rating 94V-2
 Temperature Range -40°F (-40°C) to 221°F (105°C)

Heyco® Beaded Ties

TENSILE STRENGTH		MAXIMUM BUNDLE DIAMETER		DESC.	PART NUMBERS						
Lbs.	N	in.	mm.		NYLON		POLYETHYLENE				
					Black	Natural	Black	Natural	Blue	Red	Yellow
Standard											
10	45	1-1/8	28,6	BT 4	3509	3490	3419	3420	3421	3422	3423
		1-3/8	35,0	BT 5	3519	3491	3424	3425	3426	3427	3428
18	80	1-7/8	48,0	BT 6	3523	3492	3429	3430	3431	3432	3433
		2-1/2	64,0	BT 8	3524	3493	3434	3435	3436	3437	3438
		3	76,0	BT 10	3495	3494	3439	3440	3441	3442	3443
		4	101,6	BT 14	3498	3496	3484	3480	3476	3482	3483
Nylon Push Mount*											
40	180	1-3/8	35,0	PBT 5	3499B	3499					

Standard colors: PE-black, natural, blue, red, and yellow. N-Black and natural.

*Mounts into a .250" (6,4 mm) diameter hole, maximum panel thickness .142" (3,6 mm).

Mounting Platform for Beaded Ties

- Part No. **3750**
- Adhesive backed
- May also be screw mounted
- Molded of natural nylon.

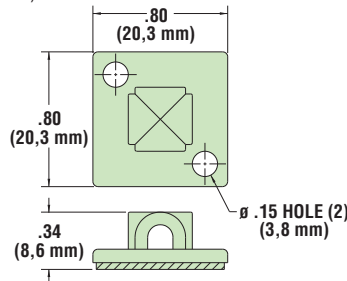
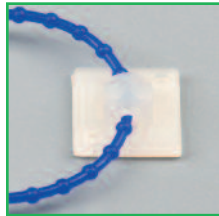

- **Releasable and reusable** ties for easy bundling, closing, bagging, holding, and tying.
- Polyethylene for high flexibility and moderate strength.
- Multiple sizes for bundles up to 4" (101,6 mm) diameter.

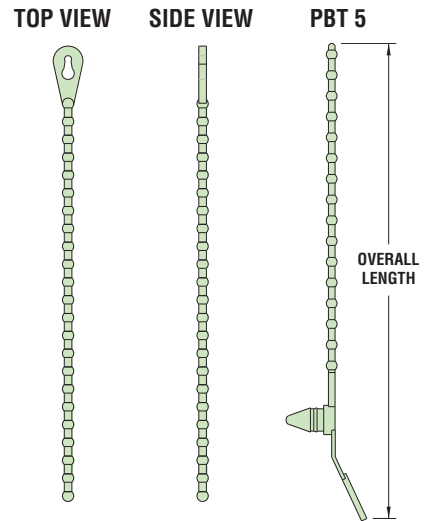

Heyco® Braided Sleeving

BUNDLE RANGE				PART NO.		DESCRIPTION	PART DIMENSIONS			
Minimum Diameter		Maximum Diameter		Black	FR Black		Nominal Diameter		Quantity Per Spool	
in.	mm.	in.	mm.			in.	mm.	ft.	mtrs.	
.09	2,3	.25	6,4	8980	8983	BS 125	.13	3,2	1000	305
.13	3,2	.44	11,1	8985	8988	BS 250	.25	6,4	500	152
.25	6,4	.75	19,1	8990	8993	BS 500	.50	12,7	250	76
.50	12,7	1.25	31,8	8995	8998	BS 750	.75	19,1	200	61
.75	19,1	1.75	44,5	9000	9003	BS 1250	1.25	31,8		
1.25	31,8	2.75	69,9	9005	9008	BS 1750	1.75	44,5		
1.50	38,1	3.50	88,9	9010	9013	BS 2.0	2.00	50,8		

Standard color black.

FR sleeving flammability rating-UL VW-1.

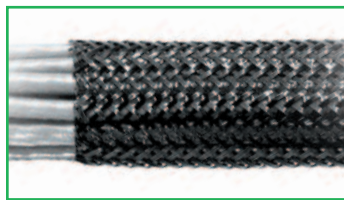

- **Braided sleeve slips on quickly and is self-fitting** over irregular shapes and contours. No wire pulling compounds are required due to its low surface friction. Slight tensioning after application makes for an even tighter fit.
- Expandable up to three times its own diameter, the open-weave construction can fit many applications, simplifying inventory. The open-weave allows for easy inspection of sleeved components and easy break out of individual cables.
- Full cable flexibility is maintained in any direction, even at low temperatures. Wires encased in Heyco Braided Sleeving can flex and bend as readily as if they had no protective oversleeving. Bundles can be flexed repeatedly without damage.
- Tough, cut-resistant sleeving is designed for protecting wire bundles and harnesses, hoses, tubing, and cable assemblies from mechanical damage and environmental hazards.
- Preferred cutting method: hot knife.

Beaded Ties		Braided Sleeving	
Material	Polyethylene or Nylon	Materials	Polyester Monofilament Yarns or Flame Retardant Polyester Yarn
Flammability Rating	94V-2	Certifications	Recognized under the Component Program of Underwriters' Laboratories File E173954
Temperature Range	40°F (0°C) to 221°F (85°C)	Monofilament Dia.	.010"
		Temperature Range	-103°F (-75°C) to 257°F (125°C)

“Stay Connected” with



Solar Power Components

a PennEngineering® Company



- **Easy to use: Just twist on wire!**
- Allows breakouts of single/multiple wires and re-routing of replacement wires.
- Absorbs vibration, insulates cables, and resists abrasion.
- Multiple sizes bundle and protect cables, wires, tubing, and hoses from .13” (3,2 mm) to 7.00” (177,8 mm) diameters.
- For hose and cable **clamps**, see pages 7-36 through 7-43.

Heyco® SunWrap™ - Polyethylene

BUNDLE RANGE				PART NO.		DESCRIPTION	PART DIMENSIONS					
Minimum Diameter		Maximum Diameter		UV Black	Natural		A Outside Diameter		B Pitch		C Thickness	
in.	mm.	in.	mm.			in.	mm.	in.	mm.	in.	mm.	
.13	3,2	1.50	38,1	8904	8905	CW 187 PE*	.19	4,8	.25	6,3	.03	0,8
.19	4,8	2.00	50,8	8908	8909	CW 250 PE	.25	6,3	.38	9,5	.05	1,1
.31	7,9	3.00	76,2	8912	8913	CW 375 PE	.38	9,5	.44	11,1	.05	1,3
.38	9,5	4.00	101,6	8916	8917	CW 500 PE	.50	12,7	.50	12,7	.06	1,6
.50	12,7	4.50	114,3	8920	8921	CW 625 PE*	.63	15,9	.63	15,9	.06	1,6
		5.00	127,0	8924	8925	CW 750 PE	.75	19,1	.75	19,1	.07	1,7
1.00	25,4	7.00	177,8	8928	8929	CW 1000 PE	1.00	25,4	1.00	25,4	.08	2,0

Standard colors UV black or natural.
* Parts are not UR recognized.

Material Certifications



Polyethylene
Recognized under the Component Program of Underwriters' Laboratories File E173954

Conforms to:

Fed Spec LP390, Mil I-631D, Mil P-21922B

Temperature Range

-76°F (-60°C) to 190°F (88°C) - UL rated temp not to exceed 122°F (50°C)

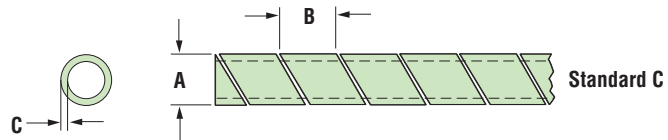

Heyco® SunWrap™ - Heavy Duty Cable Guard

BUNDLE RANGE				PART NO.		DESCRIPTION	PART DIMENSIONS					
Minimum Diameter		Maximum Diameter		Black			A Outside Dia.		B Pitch		C Thickness	
in.	mm.	in.	mm.			in.	mm.	in.	mm.	in.	mm.	
.75	19,1	1.50	38,1	8964		CWG 99 PE	.93	23,6	.95	24,1	.12	3,0
1.00	25,4	2.00	50,8	8966		CWG 126 PE	1.12	28,4	1.25	31,8	.13	3,3
1.25	31,8	2.50	63,5	8968		CWG 153 PE	1.37	34,8	1.35	34,3	.14	3,5
1.50	38,1	3.00	76,2	8970		CWG 181 PE	1.62	41,1	1.50	38,1	.15	3,9
2.00	50,8	3.50	88,9	8972		CWG 234 PE	2.09	53,1	1.60	40,6	.17	4,3
3.50	88,9	6.00	152,4	8974		CWG 401 PE	3.50	88,9	1.95	49,5	.25	6,4

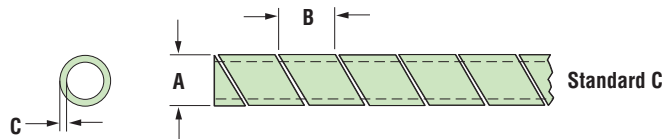

- **Easy to use: Just twist on wire!**
- Designed to shield heavier cables and cable bundles; **extend cable life.**
- Available in a **variety of sizes** that fit cable and cable bundles from .75” (19.1 mm) to 6.00” (152.4 mm) in diameter.
- **Smooth finished interior wall.**
- **Highly flexible** for ease of movement.
- Packaged as one continuous piece, not spooled.
- May be **cut to desired length**, please consult Heyco.

Quick Specs

Material

High Density Polyethylene

Flammability Rating

94-HB

Temperature Range

0°F (-18°C) to 165°F (74°C)

“Stay Connected” with



Solar Power Components

a PennEngineering® Company



Heyco® SunWrap™ -Nylon

BUNDLE RANGE				PART NO.		DESCRIPTION	PART DIMENSIONS					
Minimum Diameter		Maximum Diameter		UV Black	Natural		A Outside Diameter			B Pitch		C Thickness
in.	mm.	in.	mm.			in.	mm.	in.	mm.	in.	mm.	
.13	3,2	1.50	38,1	8936	8937	CW 187 N*	.19	4,8	.25	6,3	.02	0,5
.19	4,8	2.00	50,8	8940	8941	CW 250 N	.25	6,3	.38	9,5	.03	0,6
.31	7,9	3.00	76,2	8944	8945	CW 375 N	.38	9,5	.44	11,1		
.38	9,5	4.00	101,6	8948	8949	CW 500 N	.50	12,7	.50	12,7	.04	0,9
.50	12,7	4.50	114,3	8952	8953	CW 625 N*	.63	15,9	.63	15,9	.03	0,8
		5.00	127,0	8956	8957	CW 750 N	.75	19,1	.75	19,1		
1.00	25,4	7.00	177,8	8960	8961	CW 1000 N	1.00	25,4	1.00	25,4		

Standard colors UV black or natural.
* Parts are not UR recognized.

Material	Nylon
Certifications	Recognized under the Component Program of Underwriters' Laboratories File E173954
Temperature Range	-40°F (-40°C) to 250°F (121°C) - UL rated temp not to exceed 149°F (65°C)

- **Easy to use: Just twist on wire!**
- Allows breakouts of single/multiple wires and re-routing of replacement wires.
- Absorbs vibration, insulates cables, and resists abrasion.
- Multiple sizes bundle and protect cables, wires, tubing, and hoses from .13" (3,2 mm) to 7.00" (177,8 mm) diameters.
- Conforms to: ASTM D 4066, Group 2; Fed Spec LP410.
- For hose and cable **clamps**, see pages 7-36 through 7-43.

Heyco-Flex™ V Nylon Slit Tubing

NOMINAL DIAMETER	PART NO.	DESCRIPTION	PART DIMENSIONS						ROLL LENGTH
			A Outside Diameter		B Inside Diameter		Wall Thickness Range		
in.	Black		in.	mm.	in.	mm.	in.	mm.	ft.
1/8	1634A	HF5 1/8	.26	6,6	.17	4,3			
1/4	1635A	HF5 1/4	.39	9,9	.29	7,3			
11/32	1636A	HF5 11/32	.51	13,0	.35	8,8			
3/8	1637A	HF5 3/8	.53	13,5	.42	10,5			
7/16	1638A	HF5 7/16	.63	15,9	.44	11,2			
1/2	1639A	HF5 1/2	.64	16,2	.53	13,3	.01-.02	0,2-0,5	100
5/8	1641A	HF5 5/8	.81	20,5	.66	16,8			
3/4	1642A	HF5 3/4	.93	23,6	.79	20,1			
1	1643A	HF5 1	1.12	28,5	.92	23,3			
1-1/16	1644A	HF5 1-1/16	1.22	30,9	1.01	25,6			
1-1/4	1646A	HF5 1-1/4	1.49	37,9	1.28	32,6			
1-1/2	1649A	HF5 1-1/2	1.73	43,9	1.47	37,2			

Standard color black.

Material	Polyamide 6 Nylon
Flammability Rating	94HB
Temperature Range	-40°F (-40°C) to 239°F (115°C) Continuous -40°F (-40°C) to 374°F (190°C) Intermittent



- **Slit design allows side entry** and encirclement of preassembled harnesses and capillary tubes.
- Unique slit design allows for wire breakouts.
- Heyco-Flex V is lightweight and flexible, yet durable enough to meet your wire management requirements.
- Multiple sizes 1/8" to 1-1/2".
- All nylon construction resists salt water, weak acids, gasoline, alcohol, oil, grease, and common solvents.
- Quick installation; cuts with utility knife, PVC cutter or Heyco cutting tool #8340. See page 2-2.

Quick Specs

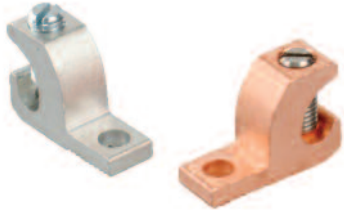

- For continuous grounding wire runs often found in solar applications.
- Available in plated and unplated versions.
- UL/CSA approved for direct burial; suitable for both indoor and outdoor use.
- Least expensive aluminum option suitable for indoor use only.
- Recommended wire range AWG 4 thru AWG 14.
- DFARS Compliant.

Heyco® Copper and Aluminum LugRunners™

Wire Range AWG	PART NO.	DESCRIPTION	CONSTRUCTION	PART DIMENSIONS (in.)					
				A	B	C	D	F	H
4-14	S6525	LC 14-4 1-Pole Cu Tinned	Tinned Copper with Stainless Steel Set Screw	1.07	.75	.38	.22	.19	.15
	S6526	LC 14-4 1-Pole Cu	Copper with Stainless Steel Set Screw						
	S6527	LC 14-4 1-Pole Al	Aluminum with Steel Set Screw						

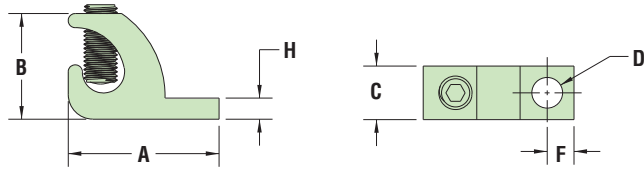

Material	Tinned copper or High Strength, High Conductive Aluminum Alloy 606/T6 with stainless steel set screw
Certifications	Listed under Underwriters' Laboratories File E467246



Heyco® SunJumpers™

- .250" hole diameter tinned copper Heavy Duty Ring Terminals at both ends.
- Terminals accept a #10 screw.
- Approved to UL 467 Grounding and Bonding standard.
- DFARS Compliant.

LENGTH		PART NO.	DESCRIPTION
in.	mm.		
6	152.4	S6506	SunJumper 6
11	279.4	S6511	SunJumper 11
18	457.2	S6518	SunJumper 18

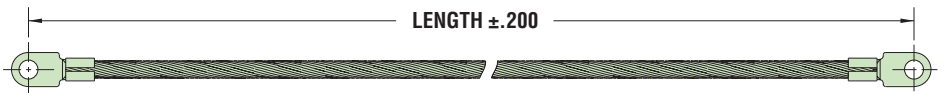

- Create bond between PV module and racking system.
- UL Recognized to UL Standard 2703
- Universal design for quick installation. Extrusions are symmetrically opposed for maximum strength.
- Stainless steel construction for maximum durability.
- DFARS Compliant.

Heyco® SunStars™

Grounding Spacers for Module to Rack Applications

PART DIMENSIONS				PART NO.	DESCRIPTION
Inside Dia.		Outside Dia.			
in.	mm.	in.	mm.		
.32	8,1	.75	19,1	S6480	SSGS 750-320
		1.00	25,4	S6481	SSGS 1000-320
		1.25	31,8	S6482	SSGS 1250-320

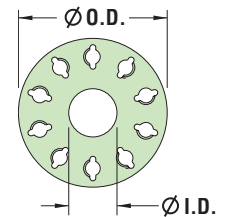

Material	6 AWG tinned copper braided wire (SunJumpers) 304 Stainless Steel (SunStars)
Certifications	Listed under Underwriters' Laboratories File E467246 (SunJumpers) Recognized under the Component Program of Underwriters' Laboratories File E467241 (SunStars)



Heyco® SunClamp™ Stainless Steel Cable Clamps

MOUNTING HOLE DIAMETER		SCREW SIZE	PART DIMENSION A		PART NO.	DESCRIPTION
in.	mm.		in.	mm.		

Standard – "P Clamp" Design

.203	5,2	10	.19	4,7	S3373	CC H 3/16 SS
			.25	6,3	S3374	CC H 1/4 SS
			.38	9,5	S3376	CC H 3/8 SS
			.50	12,7	S3378	CC H 1/2 SS
			.63	15,9	S3380	CC H 5/8 SS
			.75	19,1	S3382	CC H 3/4 SS
			.88	22,2	S3384	CC H 7/8 SS

Standard – Coated

.203	5,2	10	.19	4,7	S3323	CC H 3/16 SSC
			.25	6,3	S3324	CC H 1/4 SSC
			.38	9,5	S3326	CC H 3/8 SSC
			.50	12,7	S3328	CC H 1/2 SSC
			.63	15,9	S3330	CC H 5/8 SSC
			.75	19,1	S3332	CC H 3/4 SSC
			.88	22,2	S3334	CC H 7/8 SSC



Heyco® Steel Cushion Clamps



MOUNTING HOLE DIA.		SCREW SIZE	PART DIMENSION A		PART NO.	DESCRIPTION
in.	mm.		in.	mm.		

.650 (16,5 mm) Overall Width, .031 (0,8 mm) Steel Thickness

.265	6,7	1/4	.187	4,7	12300	CCSC L 3/16
			.250	6,3	12301	CCSC L 1/4
			.312	7,9	12302	CCSC L 5/16
			.375	9,5	12303	CCSC L 3/8
			.437	11,1	12304	CCSC L 7/16
			.500	12,7	12305	CCSC L 1/2
			.562	14,3	12306	CCSC L 9/16
			.625	15,9	12307	CCSC L 5/8
			.687	17,4	12308	CCSC L 11/16
			.750	19,1	12309	CCSC L 3/4
			.875	22,2	12310	CCSC L 7/8
			1.000	25,4	12311	CCSC L 1
			1.125	28,6	12312	CCSC L 1-1/8
			1.250	31,8	12313	CCSC L 1-1/4

.750 (19,1 mm) Overall Width, .047 (1,2 mm) Steel Thickness

.406	10,3	7/16	.250	6,3	12331	CCSC H 1/4
			.312	7,9	12332	CCSC H 5/16
			.375	9,5	12333	CCSC H 3/8
			.437	11,1	12334	CCSC H 7/16
			.500	12,7	12335	CCSC H 1/2
			.625	15,9	12337	CCSC H 5/8
			.687	17,4	12338	CCSC H 11/16
			.875	22,2	12340	CCSC H 7/8
			1.000	25,4	12341	CCSC H 1
			1.250	31,8	12343	CCSC H 1-1/4

Material 304 Stainless Steel (Stainless Steel Cable Clamps)
Zinc Plated Steel with an EPDM Sleeve (Steel Cushion Clamps)

- For clamping cable or tubing securely into place, especially in **harsh environments**.
- Smooth "coined" clamp edges prevent damage to cable insulation.
- Constructed from corrosion resistant 304 stainless steel.
- Insulated parts are constructed from 304 stainless steel and coated with polyolefin, a thermoplastic co-polymer that provides a durable non-toxic, odorless coating that has very good low temperature flexibility and excellent electrical properties. This coating also has FDA food contact approval.
- Consult Heyco for larger sizes.
- Not for use in a marine salt water environment. Contact Heyco for alternative materials.
- All parts require a .203" (5,2 mm) mounting hole suitable for a #10 screw.
- DFARS Compliant.



- Light to heavy duty steel clamp.
- E.P.D.M. cushion for electrical insulation and vibration absorption.
- Steel clamps are zinc electroplated for corrosion resistance.
- Color - Silver with durable black cushion.

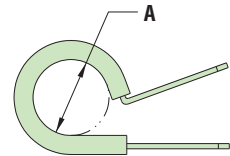

Quick Specs

“Stay Connected” with



Solar Power Components

a PennEngineering® Company



Heyco® PVB 101 Single Diode Solar Junction Box

For Single Diode, Double Ribbon Photovoltaic Panels

- **Highest performance rated axial diode on the market** for a single diode box application.
- Low insertion force connection of PV ribbons for quick and easy assembly with no soldering.
- Low profile single panel design to accommodate a two ribbon panel.
- Cable strain relief incorporated in box.
- Practical internal volume and venting for good thermal dissipation and low interior temperatures.
- RoHS and REACH compliant eco-friendly solderless internal connections.
- Sizeable opening for conductor ribbons.
- **Ambient temperature range of -40°F (-40°C) to 221°F (105°C) (UL).**

PART NO.	DESCRIPTION	PART DIMENSIONS													
		A Box Length		B Box Width		C Max O.A. Height		D Max O.A. Length		E Max O.A. Width		F Centerline of Leads		G* O.A. Length inc. Leads	
		in.	mm.	in.	mm.	in.	mm.	in.	mm.	in.	mm.	in.	mm.	in.	mm.
S6115	PVB 101	5.38	136,6	1.77	45,0	1.09	27,6	5.84	148,3	2.14	54,3	.50	12,7	78.00	1981,2

*Junction boxes supplied with positive and negative cables in 3 ft. length—contact Heyco for different lengths.

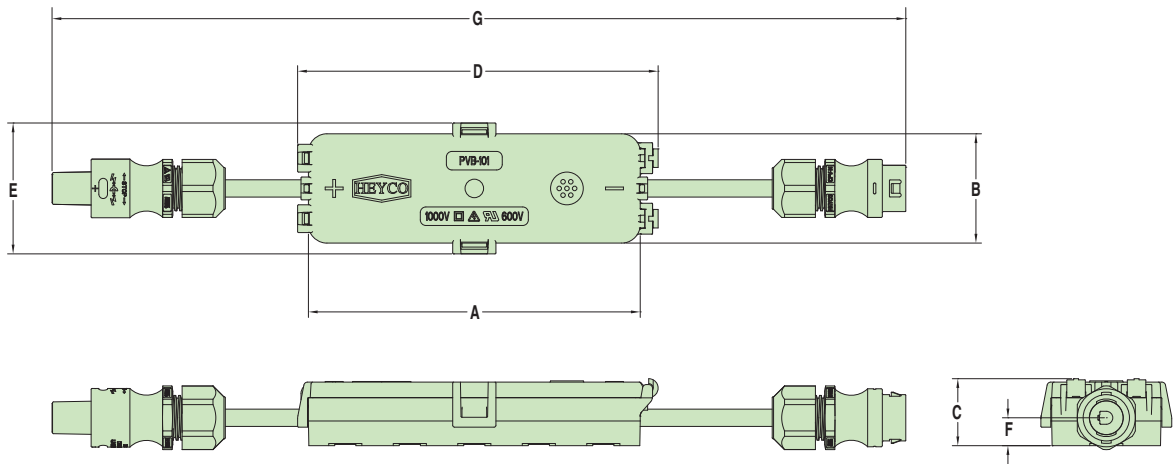

Quick Specs

Material	Polycarbonate housing with UV stability
Certifications	Recognized under Underwriters' Laboratories File E325860
Flammability Rating	VO, 5VA
Temperature Range	-40°F (-40°C) to 221°F (105°C)
IP Rating	IP 65

“Stay Connected” with



Solar Power Components

a PennEngineering® Company

Heyco® PVB 301 Multi-Diode Solar Junction Box

For Larger, Multiple Diode, Four Ribbon Photovoltaic Panels
Robust Design for Temperature Sensitive Applications

PART NO.	DESCRIPTION	PART DIMENSIONS													
		A Box Width		B Box Length		C Max O.A. Height		D Centerline of Leads		E Max O.A. Length		F Ground Lead Length		G* O.A. Length inc. Leads	
		in.	mm.	in.	mm.	in.	mm.	in.	mm.	in.	mm.	in.	mm.	in.	mm.
S6135	PVB 301	4.50	114,3	3.01	76,5	1.16	29,5	.57	14,4	4.24	107,7	36.0	914,4	40.0	1016,0

*Junction boxes supplied with positive and negative cables in 3 ft. length—contact Heyco for different lengths.

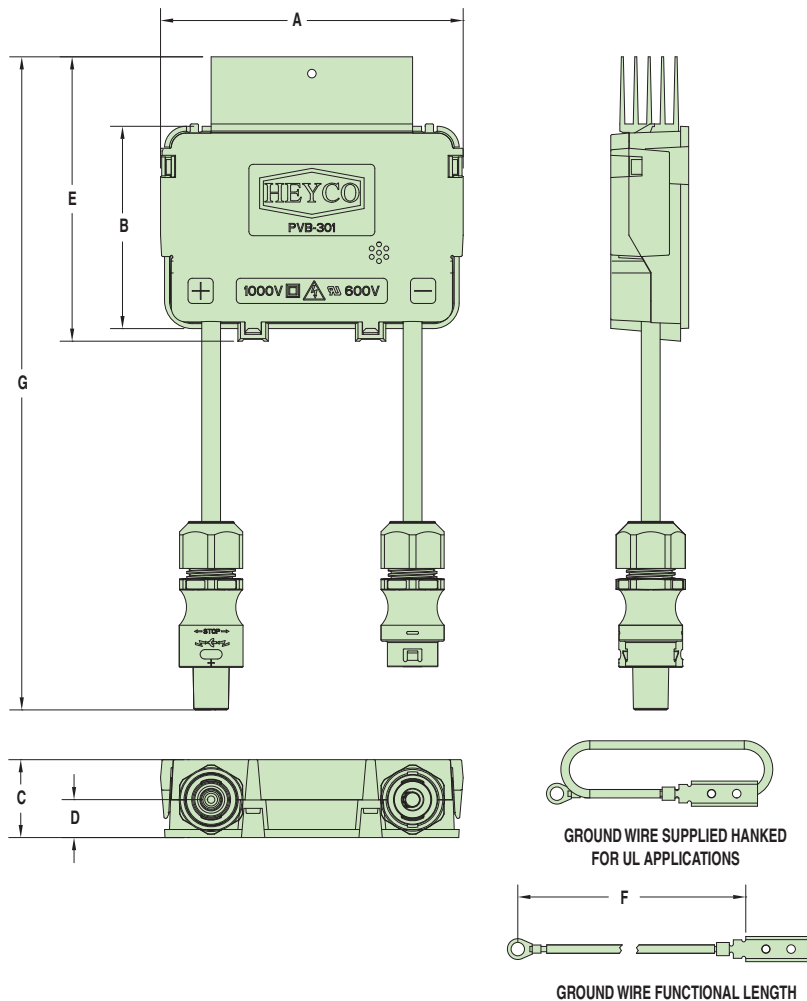

- Robust built-in heat sink guards against heat buildup and allows the use of higher current TO-220 bypass diodes. **Excellent for temperature sensitive applications.**
- Low insertion force connection of PV Ribbons for quick and easy assembly with no soldering.
- Practical internal volume and venting for good thermal dissipation and low interior temperatures.
- Maximum Voltage Rating: 600VDC UL/1000VDC IEC
- RoHS and REACH compliant eco-friendly solderless internal connections.
- Sizeable opening for conductor ribbons.
- Ground wire (included) required for UL applications.
- **U.S. Patent No. 8113853B2.**

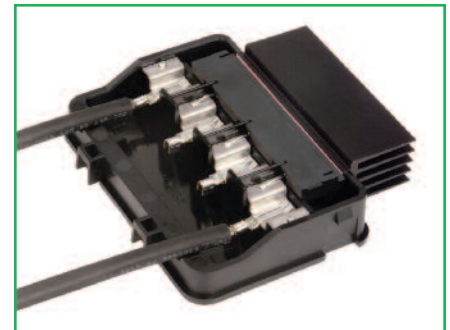

Material	Polycarbonate housing with UV stability
Certifications	Recognized under Underwriters' Laboratories File E325860 Certification Number R72111836
Flammability Rating	VO, 5VA
Temperature Range	-40°F (-40°C) to 221°F (105°C)
IP Rating	IP 65

Quick
 Specs



Heyco® PVB 001 Diodeless Solar Junction Boxes

For Use in Applications Which Require a Diodeless Junction Box

- **Low profile design** minimizes use of potting material while permitting ample access for electrical connections.
- Low cost two piece construction for potted applications.
- Durably constructed of high temperature polycarbonate with 5VA and UL f1 ratings to withstand outdoor exposure with excellent cold impact capabilities.
- Lid securely snaps on without use of tools—speeds panel fabrication.
- Designed for USE-2 and 1000V PV wire.
- Housing only—for custom connection needs, please consult Heyco.
- For special applications, please contact Heyco.

PART NO.	DESCRIPTION	PART DIMENSIONS				WIRE TYPE
		A		B		
		Hole Diameter		Maximum Cable Diameter		
		in.	mm.	in.	mm.	
S6194	PVB 001 Set (4,7 mm)	.19	4,7	.18	4,7	12 AWG USE-2
S6190	PVB 001 Set (5,1 mm)	.22	5,6	.20	5,1	10 AWG USE-2
S6192	PVB 001 Set (7,6 mm)	.31	7,9	.30	7,6	10 AWG PV-Wire

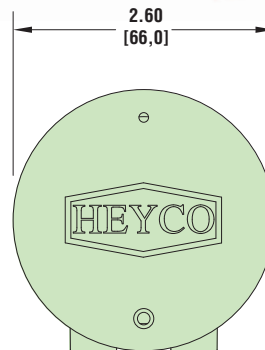

PN S6199



Optional mounting plate for use with flexible panel applications for added security



Junction Box attaches to plate clips on opposite side of panel

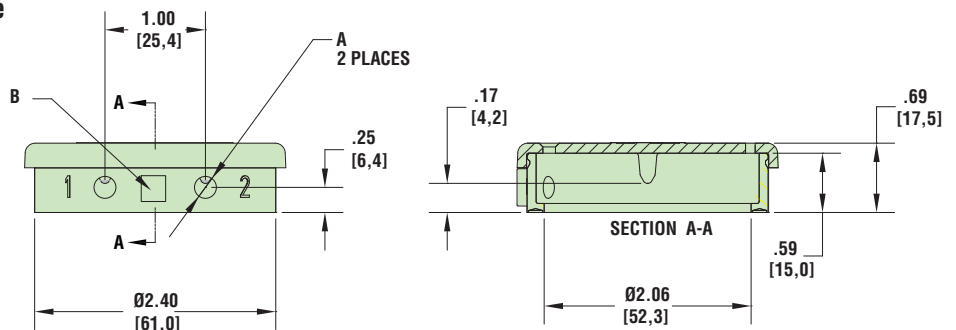

Quick Specs

Material	Polycarbonate housing with UV stability
Flammability Rating	VO, 5VA
Temperature Range	-40°F (-40°C) to 221°F (105°C)

“Stay Connected” with



Solar Power Components

a PennEngineering® Company



Heyco® CPV Solar Bulkhead Connectors

With Integral Sealing Ring for Creating a Liquid Tight Seal Through a Panel

PART NO.	DESCRIPTION	PART DIMENSIONS							
		A		B		C		D	
Black		Max O.A. Length		Mounted Length		Wrenching Flats		Clearance Hole	
		in.	mm.	in.	mm.	in.	mm.	in.	mm.
S6360	CPV-P-BH	2.08	52,8	1.47	37,3	.98	24,9	.875	22,2
S6362	CPV-N-BH	1.44	36,5	.83	21,0				



- Bulkhead connectors mate with Heyco CPV Solar Connectors **creating a liquid tight seal through the panel.**
- Provided with an assembled metal locknut.
- Integral sealing ring ensures a superior seal at the mounting hole location, every time.
- Crimp to stranded wire 14 to 10 gauge for internal connections.
- 1/2" NPT thread for installation into 1/2" knock-out hole.
- Polycarbonate construction for good chemical and impact resistance.
- Disconnection (PN S6390) and crimping tools (PN S6392 for 10 & 12 AWG wire) available, See page 1-23.
- Maximum Voltage Rating: 600VDC UL/1000VDC IEC
- RoHS and REACH compliant.
- **U.S. Patent No. 8398419B2.**

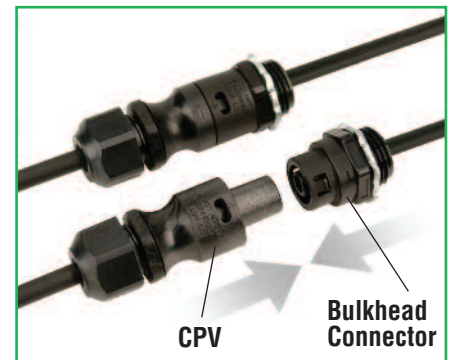
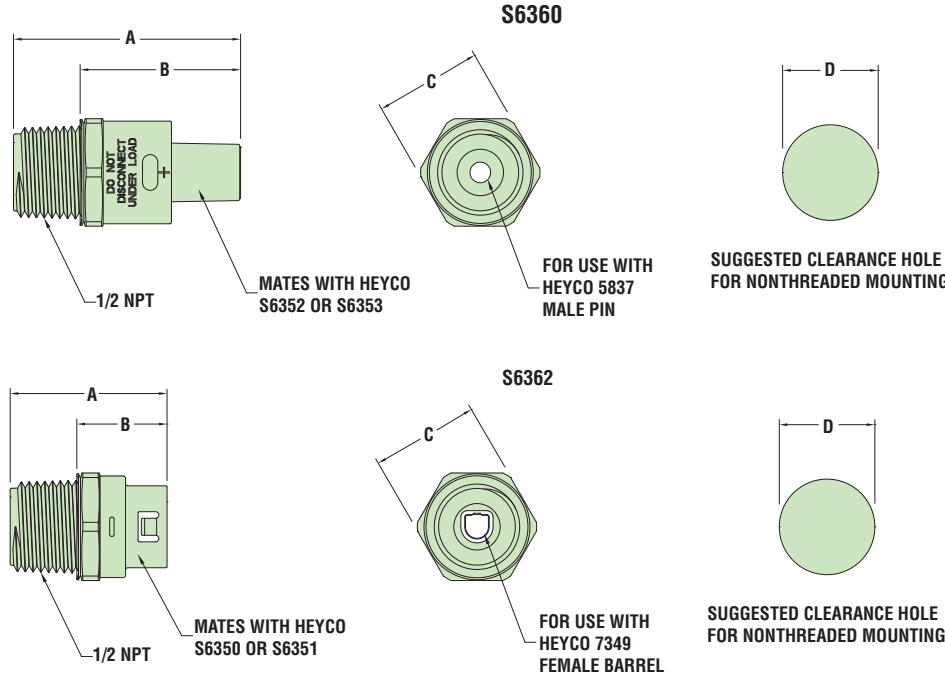

Material	Polycarbonate
Certifications	c us Recognized under the Component Program of Underwriters' Laboratories File E344722.
Flammability Rating	VO
Temperature Range	-40°F (-40°C) to 221°F (105°C)
IP Rating	IP 65 & IP 67

Quick Specs

“Stay Connected” with



Solar Power Components

a PennEngineering® Company



Heyco® CPV Solar Connectors

For Photovoltaic Wire Interconnections

- **Large cable diameter range** covers a wide range of USE-2 and 1000V PV cables.
- CPV Solar Connectors mate with Heyco Bulkhead Connectors (page 1-22) creating a liquid tight seal through the panel.
- Acme threads on cap to prevent skipping and speed install.
- **Connectors meet all UL cold impact requirements of -35°C test.**
- **Connectors meet all NEC requirements for solar installations.**
- Polycarbonate construction for good chemical and impact resistance.
- Rated Current: 22A (2,5 mm²), 30A (4 mm²-6 mm²).
- Rated Voltage, 1kV DC.
- Overvoltage category III.
- Pollution degree, 3.
- Crimped terminal connections.
- Non-rewireable conductor connections.
- Reference to DIN V VDE V0126-3:2006.
- RoHS and REACH compliant.
- **U.S. Patent No. 8398419B2.**

CABLE DIA. RANGE				PART NO.	DESCRIPTION	PART DIMENSIONS					
Min Dia		Max Dia				Black	A Max O.A. Length		B Body Length		C Wrenching Flats
in.	mm.	in.	mm.		in.		mm.	in.	mm.	in.	mm.
.26	6,6	.32	8,0	S6350	CPV-P-80	2.80	71,1	2.17	55,1	.94	23,9
.17	4,3	.23	5,8	S6351*	CPV-P-58						
.26	6,6	.32	8,0	S6352	CPV-N-80	2.16	54,9	1.78	45,2	.94	23,9
.17	4,3	.23	5,8	S6353*	CPV-N-58						

*For TUV certification, the minimum cable diameter will be .208 in (5,3 mm).

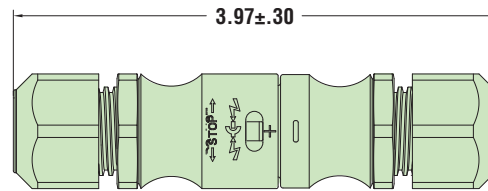

ASSEMBLED VIEW

POSITIVE CONNECTOR

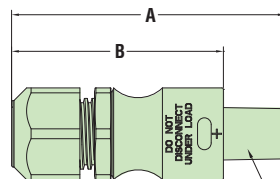

MATES WITH HEYCO
S6352 OR S6353

S6350/S6351

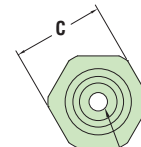

FOR USE WITH
HEYCO 5837
MALE PIN

NEGATIVE CONNECTOR

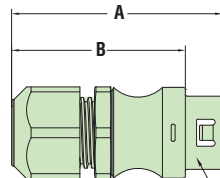

MATES WITH HEYCO
S6350 OR S6351

S6352/S6353

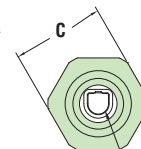

FOR USE WITH
HEYCO 7349
FEMALE BARREL



Heyco
CPV Solar
Disconnection
Tool S6390



Heyco CPV
Solar Crimping
Tool S6392

Material	Polycarbonate
Certifications	Recognized under the Component Program of Underwriters' Laboratories File E344722.
Flammability Rating	V0
Temperature Range	-40°F (-40°C) to 185°F (85°C)
IP Rating	IP 65 & IP 67

“Stay Connected” with



Solar Power Components

a PennEngineering® Company



Heyco® CPV Solar Connector Sets

With Custom Termination Capability

TYPE	CABLE		PART NO.	TERMINATIONS			LENGTH * A ft.
	Gauge AWG	Type		B	C	D in.	
CPV-P Connection Cable	10	USE-2	S6310-6.0	CPV-P	none*	1/2	6.0
		PV 1000	S6311-6.0				
CPV-N Connection Cable	10	USE-2	S6314-6.0	CPV-N	none*	1/2	6.0
		PV 1000	S6315-6.0				
CPV-P/CPV-N Jumper Cable	10	USE-2	S6318-6.0	CPV-P	CPV-N	n/a	6.0
		PV 1000	S6319-6.0				
CPV/MC4 Conversion Cable	10	USE-2	S6322-6.0	CPV-P	MC-4-NEG	n/a	6.0
			S6323-6.0	CPV-N	MC-4-POS		
		PV 1000	S6326-6.0	CPV-P	MC-4-NEG		
			S6327-6.0	CPV-N	MC-4-POS		

- **Precut and terminated CPV assemblies.**
- Constructed from UV resistant 10AWG UL/TUV approved solar cable.
- Suitable for UL and IEC solar installations.
- **Heyco Connectors are UL and TUV approved.**
- **Connectors meet UL cold impact test of -35°C.**
- **Connectors meet all NEC requirements for solar installations.**
- Maximum cable assembly current rating - 30 amps.
- MC4 conversion cables and additional cable lengths available upon request.

*Other lengths available. Consult Heyco for custom lengths, applied Ring/Spade Terminals and other configurations.

CPV CONNECTION CABLES

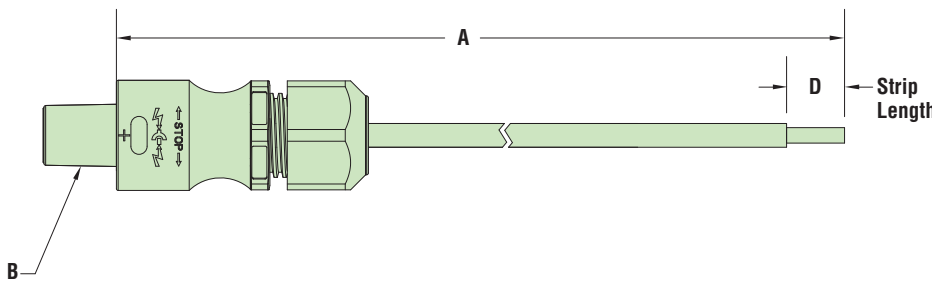

CPV JUMPER & CONVERSION CABLES

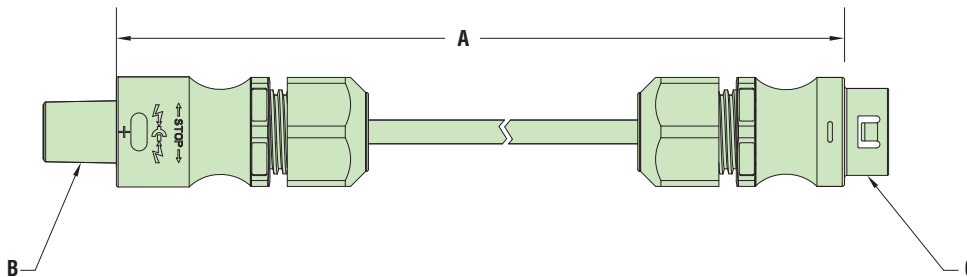

Material	Polycarbonate
Certifications	Recognized under the Component Program of Underwriters' Laboratories File E344722. Certification Number R60033714.
Flammability Rating	V0
Temperature Range	-40°F (-40°C) to 185°F (85°C)
IP Rating	IP 65 & IP 67

Quick Specs

“Stay Connected” with



Solar Power Components

a PennEngineering® Company



Heyco® SunScreener® Wire Mesh Clip

- Helps protect solar panels from rodents and nesting birds with wire mesh screening (screening not included). See Heyco Sunscreen below.
- Constructed from 303 and 304 Stainless Steel for maximum endurance to outdoor elements.
- 303 Stainless Steel J-Hook easily attaches to the solar panel frames and can easily be trimmed or bent after assembly.
- 304 Stainless Steel Washers will firmly hold wire mesh screen to the module assembly preventing squirrels and rodents from damaging the interconnection wires and birds from building nests under the solar panel.
- Does not violate panel integrity.
- Installs quickly and easily with standard linesman pliers
- Black color available for those applications subject to **HOA appearance restrictions**.
- Stainless Steel Washers are offered in both steel color and black painted versions.
- Not for use in a marine salt water environment. Contact Heyco for alternative materials.
- DFARS Compliant

PART NO.		PART DIMENSIONS									
Steel Gray	Black	A		B		C		D		E	
		Overall Length		Diameter		Width		Height		Washer Diameter	
		in.	mm.	in.	mm.	in.	mm.	in.	mm.	in.	mm.
Stainless Steel											
S6437	S6438	4.87	124,0	.08	2,0	.38	9,7	.38	9,7	1.00	25,4

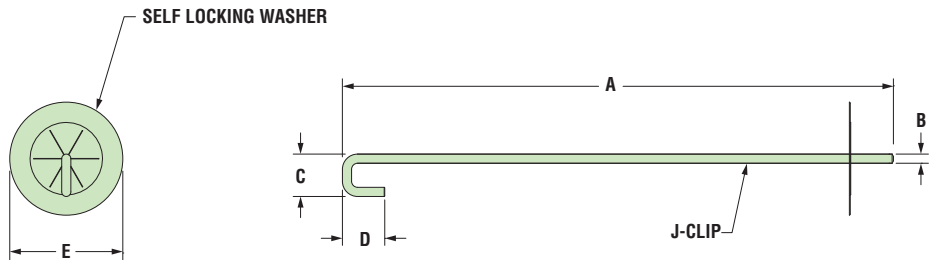

Heyco® SunScreen™

Wire Mesh - For use with Heyco SunScreener Clips

PART NO.	PART DIMENSIONS	
	Black	Length
	Width	feet
	in.	
S6464	4	100´
S6466	6	Rolls
S6468	8	

- Mesh dimension is 1/2" x 1/2".
- DFARS Compliant
- For SunScreener Clips and SunScreen Mesh bundled in **Kit** form, see page 1-27.

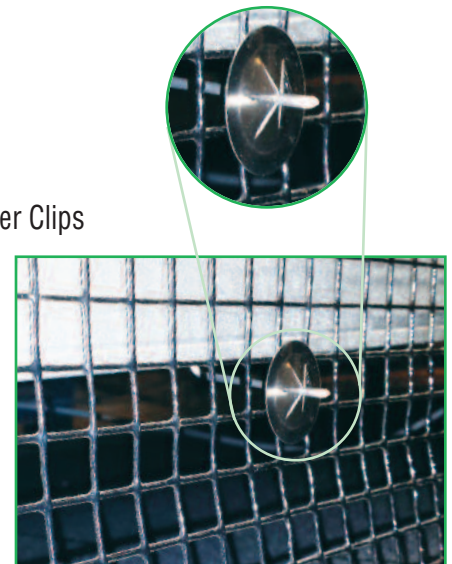

Quick Specs

SunScreener Wire Mesh Clip
Material J-Hook 303 Stainless steel
Washer 304 Stainless steel

SunScreen Wire Mesh
PVC Coated, galvanized welded steel mesh

Heyco® Solar Power Components Used in Typical Grid-Tied PV System

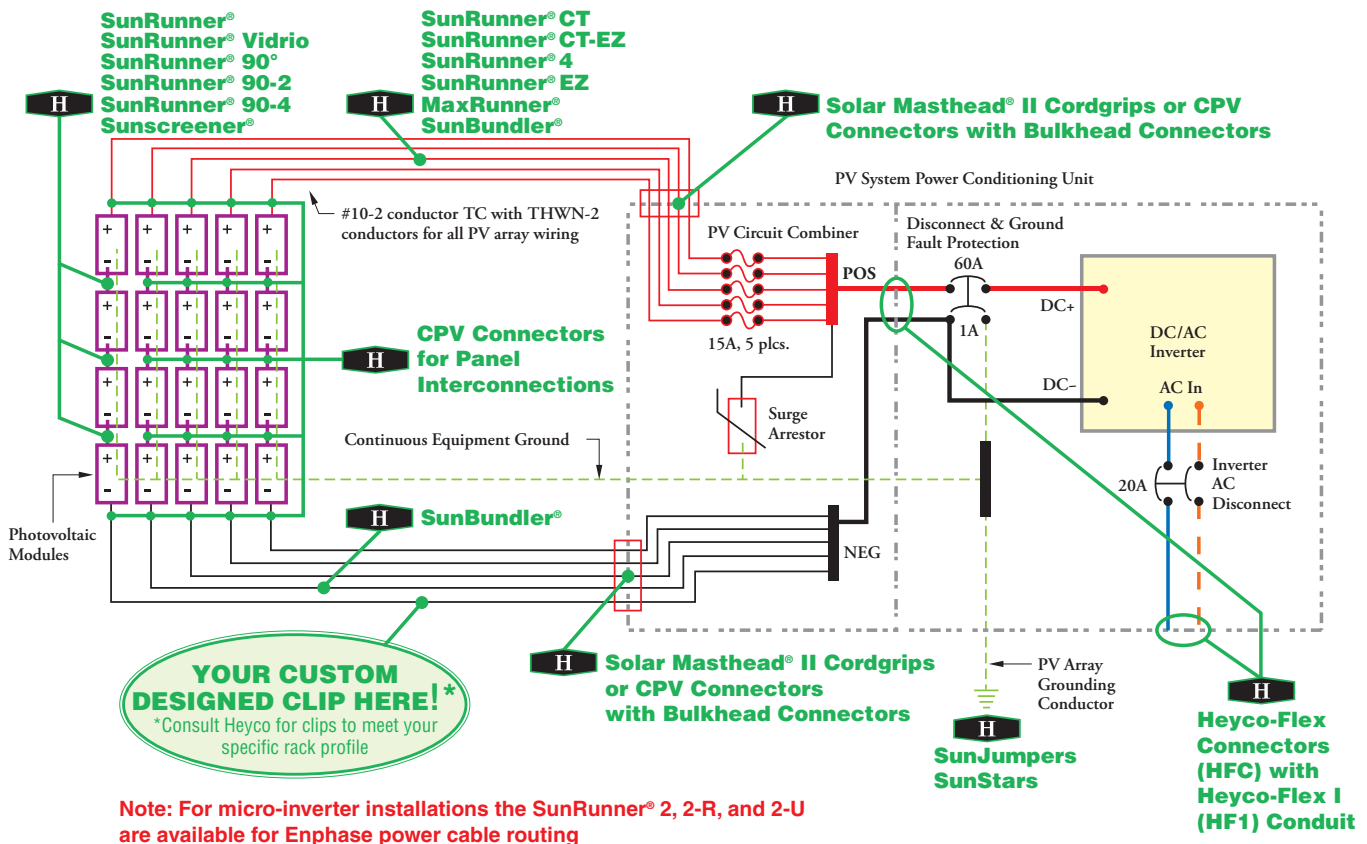

Note: For micro-inverter installations the SunRunner® 2, 2-R, and 2-U are available for Enphase power cable routing

“Stay Connected” with



Solar Power Components

a PennEngineering® Company

Heyco® Solar Power Components LabKit #9 (Part No. 3000)

Use Heyco LabKits!

- Heyco LabKits are perfect for product design departments, experimental labs, and for all prototype work.
- The Heyco Solar Power Components LabKit #9 contains an assortment of our most popular Solar Panel Connectors, Cordgrips, Clips and other accessories.
- Heyco also offers LabKits for Liquid Tight Cordgrips, Strain Relief Bushings, Hole Plugs, HEYware, and Grommets.
- Parts in LabKits are available in various sizes and colors. Please consult Heyco for further information.

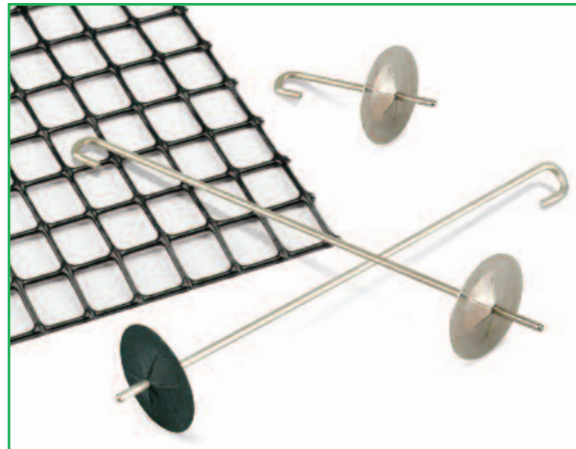

Heyco® SunScreenKit™

36 pieces of PART NO. **S6437** SunScreen Clips bundled together with one 100' Roll of SunScreen Wire Mesh

For Clip and Screen product details, see page 1-25

KIT NO.	CLIP QTY.	MESH	
		Width in.	Length ft.
S6465	36	4	100' Roll
S6467	36	6	
S6469	36	8	



Please visit heycosolar.com for details on Heyco's Twenty Year Solar Products Warranty

www.HeycoSolar.com

HEYCO®
Liquid Tight
Flexible Conduit,
Tubing and
Fittings



2-1 Heyco-Flex III 94V-0 Flexible, Nylon Liquid Tight Tubing



2-1 Female Threaded Couplings



2-2 Heyco-Flex III Liquid Tight Fittings - Straight-Thru, Snap-In



2-2 Heyco-Flex III Liquid Tight Fittings - Straight-Thru, NPT



2-2 Heyco-Flex III Liquid Tight Fittings - 90° Sweep, NPT

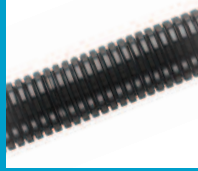

2-3 Nylon Corrugated Conduit/Tubing - Highly Flexible HPAS



2-4 Nylon Corrugated Conduit/Tubing Mounting Clips



2-4 Nylon Corrugated Conduit/Tubing Unions



2-5 Nylon Conduit Fittings - Straight-Thru, NPT, Metric



2-6 Nylon Conduit Fittings - 90° Sweep, NPT, Metric



2-7 Heyco-Flex I Flexible Nonmetallic Conduit



2-7 Heyco-Flex I Female Conduit Adapters



2-8 Heyco-Flex II Flexible Nonmetallic Tubing



2-9 Heyco-Flex Liquid Tight Connectors - Straight-Thru, NPT



2-10 Heyco-Flex Liquid Tight Connectors - Straight-Thru, Snap-In



2-11 Heyco-Flex Liquid Tight Connectors - 90° Sweep, NPT



2-12 Heyco-Flex Metallic Liquid Tight Conduit Fittings Straight-Thru, NPT



2-12 Heyco-Flex Metallic Liquid Tight Conduit Fittings 90° Sweep, NPT



2-13 Heyco-Flex Quick Twist Conduit Fittings Straight-Thru, Snap-In



2-13 Heyco-Flex Quick Twist Liquid Tight Conduit Fittings Straight-Thru, NPT



2-13 Heyco-Flex Quick Twist Finishing Collars



2-14 Heyco-Flex Quick Twist Conduit Fittings 90° Sweep, Snap-In



2-14 Heyco-Flex Quick Twist Conduit Fittings 90° Sweep, NPT



2-14 Quick Twist Assembly Tool



2-15 Heyco-Flex VI Liquid Tight Conduit



2-16 Heyco-Flex IV Liquid Tight Fittings - Straight-Thru, NPT



2-16 Heyco-Flex IV Liquid Tight Fittings - 90° Sweep, NPT



2-17 Metal Locknuts - NPT (NPS), Pg & Metric



2-18 Nylon Locknuts - NPT (NPS), Pg & Metric



2-19 Heyco-Flex Mounting Brackets



2-19 Sealing Washers



2-20 Foam Washers



2-20 Thermoplastic O-Rings

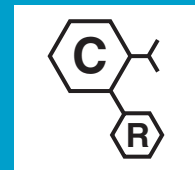

2-21 Corrugated Conduit Systems Chemical Resistance

“Stay Connected” with



Liquid Tight Conduit, Tubing & Fittings

a PennEngineering® Company



Heyco-Flex™ III Nylon 94V-0 Corrugated Liquid Tight Tubing

Flexible, Nonmetallic Liquid Tight Electrical Tubing

- Corrugated tubing for trade sizes 3/8" through 1".
- Flame retardant, won't burn.
- Nontoxic and UV resistant.
- **Rated for NEMA 4 and 4X applications when used with Heyco-Flex III Liquid Tight Fittings.**
- Rated for NEMA Type 3R applications.
- Maximum flexibility, can be used in extremely tight quarters. Bend radius of Heyco-Flex III is equal to its outside diameter.
- No threading of the tubing required to install. This eliminates the possibility of cutting the tubing and creating leak paths.
- Easy, permanent assembly between the tubing and fittings: push the tubing over the fitting ferrule until the tubing clicks into place.
- Lightweight and lower installed cost.
- Quick and easy installation.
- For use with Heyco-Flex III Fittings, See page 2-2.
- Resists corrosion, oil, and water.
- For use in both wet and dry applications.
- Suitable for use in high vibration or flexing applications (automotive equipment, fiber optics, computer and peripherals, lab equipment, robotics, etc.).
- **Voltage Rating: 300V.**
- **Mounting brackets are available, see page 2-19.**
- **Order Part No. 8340**, HF-28 Cutting Tool, for cutting Heyco-Flex Tubing cleanly and evenly. See page 2-8.
- For additional nylon conduit sizes, see page 2-3.

TRADE SIZE	PART NO. Black	DESCRIPTION	PART DIMENSIONS				STANDARD COIL LENGTH*
			A Outside Diameter		B Inside Diameter		
			in.	mm.	in.	mm.	ft/coil
3/8	8478	HF3 3/8 FR	.71	18,0	.51	13,1	100
1/2	8479	HF3 1/2 FR	.85	21,6	.65	16,5	
3/4	8480	HF3 3/4 FR	1.12	28,3	.87	22,0	
1	8481	HF3 1 FR	1.35	34,3	1.10	28,0	

Standard color black. Consult Heyco for gray and other colors.
*Consult Heyco for "cut to length" and slit tubing availability.

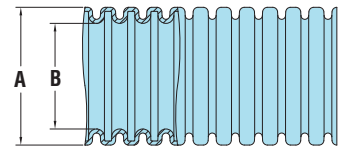

Material	Halogen Free Nylon 6
Certifications	cULus Certified to both Canadian and U.S. Requirements under File E121095
Flammability Rating	94V-0
Temperature Range	-4°F (-18°C) to 221°F (105°C)



Heyco® Female Threaded Couplings

For Heyco HF3C and other NPT Hub Components

- Both ends feature female NPT threads for joining various male NPT hub parts.
- Facilitate the connection between Heyco-Flex III Fittings (HF3C – page 2-2), Conduit (HF3 – above), and the various Heyco Liquid Tight Cordgrips (Section 3) typically used in solar installations.

TRADE SIZE	PART NO. Gray	DESCRIPTION
1/2	8665	FTC 1/2
3/4	8666	FTC 3/4
1	8667	FTC 1
1-1/4	8668	FTC 1-1/4
1-1/2	8669	FTC 1-1/2
2	8670	FTC 2

Material	Schedule 80 PVC
----------	-----------------

Quick Specs



Heyco-Flex™ III Liquid Tight Fittings

For Flexible, Nonmetallic Liquid Tight Tubing
Straight-Thru, Snap -in and NPT Hubs

FITS TUBING TRADE SIZE	PART NO.	DESCRIPTION	THREAD SIZE	PART DIMENSIONS											
				A Clearance Hole		B Max O.A. Length		C Thread Length		D Wrenching Nut Thk.		E Flat Size			
	Black			in.	mm.	in.	mm.	in.	mm.	in.	mm.	in.	mm.	in.	mm.
Snap-in Hub*															
1/2	1952	HF3C 1/2-S	N/A	.875	22,2	1.38	35,1	.39	9,9	.09	2,3	.97	24,6		
NPT Hubs															
3/8	9146	HF3C 3/8	3/8	.875	22,2	1.72	43,7	.63	16,0	.20	5,1	1.16	29,5		
1/2	9147	HF3C 1/2	1/2												
3/4	9148	HF3C 3/4	3/4	1.109	28,2	1.84	46,7	.63	16,0	.20	5,1	1.36	34,5		
1	9149	HF3C 1	1	1.375	34,9	1.99	50,6	.78	19,8	.20	5,1	1.62	41,1		

*Part is not liquid tight or UL Recognized. "Thread Length" indicates length below flange.

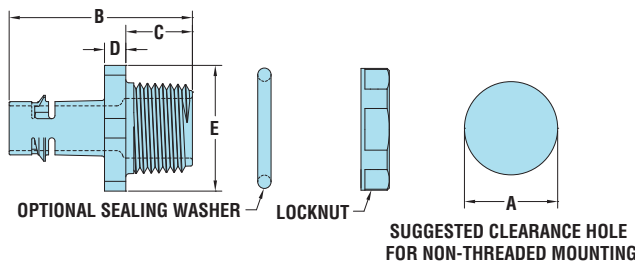

90° Sweep, NPT Hubs

FITS TUBING TRADE SIZE	PART NO.	DESCRIPTION	THREAD SIZE	PART DIMENSIONS											
				A Clearance Hole		B Max O.A. Height		C Max O.A. Length		D Thread Length		E Flange Dia.			
	Black			in.	mm.	in.	mm.	in.	mm.	in.	mm.	in.	mm.	in.	mm.
3/8	1955	HF3C 3/8-90R	3/8	.875	22,2	1.75	44,5	2.74	69,6	.52	13,2	1.23	31,2		
1/2	1956	HF3C 1/2-90R	1/2												
3/4	1957	HF3C 3/4-90R	3/4	1.109	28,2	2.10	53,3	3.08	78,2	.52	13,2	1.50	38,1		
1	1958	HF3C 1-90R	1	1.375	34,9	2.67	67,8	3.66	93,0	.69	17,5	1.80	45,7		

Standard color black.

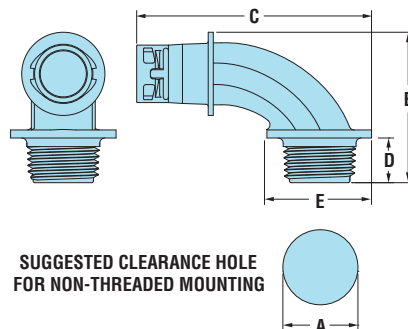

Material	Nylon 6/6
Certifications	e _{RU} us Certified to both Canadian and U.S. Requirements File E121095
Flammability Rating	94V-2
Temperature Range	-22°F (-30°C) to 221°F (105°C)
IP Rating	IP 64

- For use with Heyco-Flex III Corrugated Tubing in trade sizes 3/8" through 1". See page 2-1.
- Nontoxic and UV resistant.
- **Rated for NEMA 4 and 4X applications when used with Heyco-Flex III Tubing.**
- Rated for NEMA Type 3R applications.
- Easy, permanent assembly between the tubing and fittings: push the tubing over the fitting ferrule until the tubing clicks into place.
- Lightweight and lower installed cost.
- Quick and easy installation.
- Suitable for use in high vibration or flexing applications (automotive equipment, fiber optics, computer and peripherals, lab equipment, robotics, etc.).
- Resist salt water, weak acids, gasoline, alcohol, oil, grease, and common solvents. This feature is not assessed by UL certification or testing.
- For use in both wet and dry applications.
- If using a tapped hole, Teflon® tape is needed on the threads of the connector, for all other applications an O-ring and Locknut are needed to attain liquid tight.
- Use of an O-ring may be required for a complete liquid tight system with a non-threaded mounting hole. See page 2-20.
- Locknuts **included** with Straight-Thru fittings.
- To order metal or nylon locknuts separately, see pages 2-17 & 2-18.
- Patented.

Quick Specs

Heyco® Nylon Corrugated Conduit/Tubing – HPAS Series

Highly Flexible Polyamide Nylon 6



Type HPAS

- Low fire hazard.
- Low smoke and toxicity.
- Halogen, sulphur, and phosphorus free.
- Highly flexible and high fatigue life.
- High impact strength and recovers if crushed.
- Lightweight and low installed cost.
- Use with Heyco Nylon Fittings. See pages 2-5 through 2-6.
- UV resistant.
- For use with all types of equipment, machinery, pumps, motors, and HVAC equipment.
- 10 mm thru 54 mm nominal sizes.
- Highly resistant to abrasion, oil, and solvents.
- Voltage Rating: 300V.
- Suitable for use in outdoor locations.
- See Page 2-4 for mounting clips.
- See Pages 2-21 for technical specifications.

NOMINAL SIZE	PART NO. Black		DESCRIPTION	PART DIMENSIONS							
	94V-2	94V-0		A				B		Roll Length	
				Inside Bend Radius		Inside Diameter		Outside Diameter		Ft.	M.
			in.	mm.	in.	mm.	in.	mm.			
10 mm	F8400	F8421	HPAS 10MM 50M COIL	.59	15,0	.24	6,2	.39	10,0	164	50
13 mm	F8402	F8422	HPAS 13MM 50M COIL	.79	20,0	.38	9,6	.51	13,0		
16 mm	F8404	F8424	HPAS 16MM 50M COIL	1.18	30,0	.47	12,0	.62	15,8		
21 mm	F8406	F8426	HPAS 21MM 50M COIL	1.57	40,0	.65	16,5	.84	21,2		
28 mm	F8410	F8432	HPAS 28MM 50M COIL	2.17	55,0	.88	22,3	1.12	28,5		
34 mm	F8414	F8434	HPAS 34MM 50M COIL	2.56	65,0	1.11	28,2	1.36	34,5	82	25
42 mm	F8416	F8436	HPAS 42MM 25M COIL	3.15	80,0	1.42	36,0	1.67	42,5		
54 mm	F8418	F8438	HPAS 54MM 25M COIL	3.74	95,0	1.85	47,1	2.15	54,5		

Standard color black.

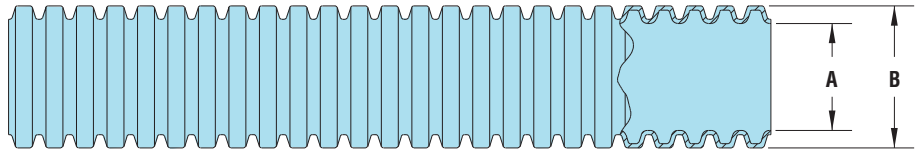

Quick Specs

Material	Nylon 6 (PA6)
Certifications	Recognized under Underwriters' Laboratories' File E121095 for both U.S. and Canadian requirements
Flammability Rating	94V-2 and 94V-0 Halogen Free
Temperature Range	-4°F (-20°C) to 221°F (105°C)
IP Rating	IP 66 with HPASC Fittings Per EN60529

Heyco® Nylon Corrugated Conduit/Tubing Mounting Clips

With Integral Closure



FITS CONDUIT SIZE	PART NO. Black	DESCRIPTION	PART DIMENSIONS							
			A Mounting Hole Dia.		B Width		C Max O.A Height		D Max. O.A. Thickness	
			in.	mm.	in.	mm.	in.	mm.	in.	mm.
13 mm	F8902	HCL 13	.197	5,0	.89	22,7	1.04	26,4		
16 mm	F8904	HCL 16	.205	5,2	1.04	26,4	1.17	29,8		
21 mm	F8906	HCL 21	.244	6,2	1.25	31,8	1.44	36,5	.79	20,0
28 mm	F8908	HCL 28	.244	6,2	1.61	40,8	1.75	44,5		
34 mm	F8910	HCL 34	.244	6,2	1.89	48,0	2.03	51,5		
42 mm	F8912	HCL 42	.244	6,2	2.25	57,2	2.37	60,2		

Standard color black.

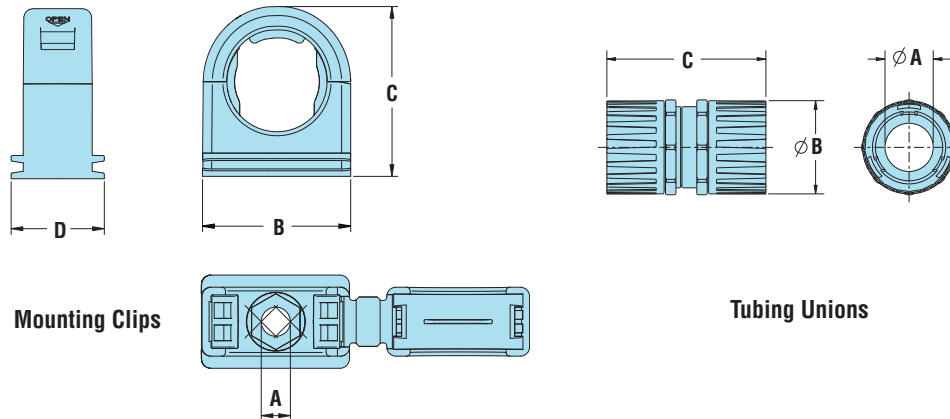

- For mounting Heyco Nylon Corrugated Conduit or Tubing securely into place, vertically or horizontally. See page 2-3.
- Low profile design for space savings and pleasing appearance.
- Only fingertip pressure is required to snap conduit or tubing into bracket.
- Can be easily opened for temporary access/removal and closed again to secure conduit.
- Suitable for use with both fine and/or coarse pitch conduit/tubing.
- Suitable for use by original equipment manufacturers.
- Resist salt water, weak acids, gasoline, alcohol, oil, grease, and common solvents. (This feature is not assessed by UL certification or testing.)
- Recommended distance between brackets at intervals not greater than 3 feet (914 mm) as required by Article 351-27 of 1996 NEC.
- Use one standard #10 (4-5M) screw for attaching bracket to panel or chassis (screw not included).

Heyco® Nylon Corrugated Conduit/Tubing Unions

FITS CONDUIT SIZE	PART NO. Black	DESCRIPTION	PART DIMENSIONS					
			A Bore		B Max. Diameter		C Length	
			in.	mm.	in.	mm.	in.	mm.
16 mm	F8944	HPAS 16 - HPAS 16	.43	11,0	1.14	29,0	2.32	59,0
21 mm	F8946	HPAS 21 - HPAS 21	.57	14,5	1.26	32,0	2.80	71,0
28 mm	F8948	HPAS 28 - HPAS 28	.77	19,5	1.73	44,0	3.19	81,0
34 mm	F8950	HPAS 34 - HPAS 34	1.04	26,5	2.01	51,0	3.43	87,0

Standard color black.

- One piece fast fit coupler to join corrugated conduit



Material	Nylon 6/6
Certifications	CE Approved as per BS EN50086
Flammability Rating	94V-2 and Low Fire Hazard Including Low Smoke, Low Toxicity as well as Halogen, Sulphur, and Phosphorus Free
Temperature Range	-58°F (-50°C) to 275°F (135°C)

Quick Specs

“Stay Connected” with



Liquid Tight Conduit, Tubing & Fittings

a PennEngineering® Company



Heyco® Nylon Conduit Fittings - Straight-Thru

For Flexible, Corrugated Nylon Conduit/Tubing

FITS CONDUIT SIZE	PART NO.		DESCRIPTION	THREAD SIZE	PART DIMENSIONS - BODY AND SEALING NUT									
	Black	V-0 Black			A Clearance Hole		B Max O.A. Length		C Thread Length		D Wrenching Nut Thk.		E Wrenching Flat	
					in.	mm.	in.	mm.	in.	mm.	in.	mm.	in.	mm.
NPT Hubs														
10 mm	H8501	H8501F	HPASC 1/4 NPT-10mm	1/4 NPT	.540	13,7	1.58	40,0	.47	11,9	.19	4,8	.97	24,6
13 mm	H8503	H8503F	HPASC 3/8 NPT-13mm	3/8 NPT	.680	17,3	1.77	45,0	.50	12,7	.19	4,8	1.15	29,2
16 mm	H8504	H8504F	HPASC 3/8 NPT-16mm	3/8 NPT	.680	17,3	1.87	47,5	.52	13,2	.19	4,8	1.34	34,0
	H8506	H8506F	HPASC 1/2 NPT-16mm	1/2 NPT	.875	22,2	1.99	50,5	.64	16,3				
21 mm	H8510	H8510F	HPASC 1/2 NPT-21mm	1/2 NPT	.875	22,2	1.99	50,5	.63	16,0	.19	4,8	1.49	37,9
28 mm	H8516	H8516F	HPASC 3/4 NPT-28mm	3/4 NPT	1.109	28,1	2.07	52,5	.63	16,0	.19	4,8	1.80	45,7
34 mm	H8520	H8520F	HPASC 1 NPT-34mm	1 NPT	1.375	34,9	2.34	59,5	.76	19,3	.19	4,8	1.95	49,5
42 mm	H8522	H8522F	HPASC 1-1/4 NPT-42mm	1-1/4 NPT	1.734	44,0	2.44	62,0	.79	20,1	.22	5,5	2.54	64,5
	H8524	H8524F	HPASC 1-1/2 NPT-42mm	1-1/2 NPT	1.984	50,4	2.41	61,7						
54 mm	H8528	H8528F	HPASC 2 NPT-54mm	2 NPT	2.469	62,7	2.44	62,0	.80	20,3	.22	5,5	2.74	69,6
Metric Hubs														
10 mm	H8570	H8570F	HPASC M12-10mm	M12	.473	12,0	1.58	40,0	.45	11,4	.19	4,8	.98	24,9
13 mm	H8572	H8572F	HPASC M16-13mm	M16	.630	16,0	1.77	45,0	.49	12,5	.19	4,8	1.16	29,5
16 mm	H8574	H8574F	HPASC M16-16mm	M16	.630	16,0	1.87	47,5	.49	12,5	.19	4,8	1.35	34,3
	H8576	H8576F	HPASC M20-16mm	M20	.787	20,0	1.99	50,5	.61	15,5				
21 mm	H8580	H8580F	HPASC M20-21mm	M20	.787	20,0	1.99	50,5	.61	15,5	.19	4,8	1.50	38,0
28 mm	H8586	H8586F	HPASC M25-28mm	M25	.984	25,0	2.07	52,5	.62	15,8	.19	4,8	1.81	46,0
34 mm	H8590	H8590F	HPASC M32-34mm	M32	1.260	32,0	2.34	59,5	.76	19,3	.19	4,8	1.97	50,0
42 mm	H8592	H8592F	HPASC M40-42mm	M40	1.575	40,0	2.44	62,0	.78	19,8	.22	5,5	2.56	65,0
	H8594	H8594F	HPASC M50-42mm	M50	1.969	50,0	2.26	57,5						
54 mm	H8598	H8598F	HPASC M63-54mm	M63	2.480	63,0	2.28	58,0	.63	16,0	.22	5,5	2.76	70,0

Standard color black.

- No disassembly required. Instead the installer simply pushes the conduit or tubing into the fitting, then tightens the domed sealing nut.
- Silicone sealing gland ensures liquid-tight seal.
- No threading of the conduit or tubing is required to install. This eliminates the possibility of cutting the conduit and creating leak paths.
- Multiple sizes available for use with Heyco-Flex Conduit and Tubing. See page 2-3.

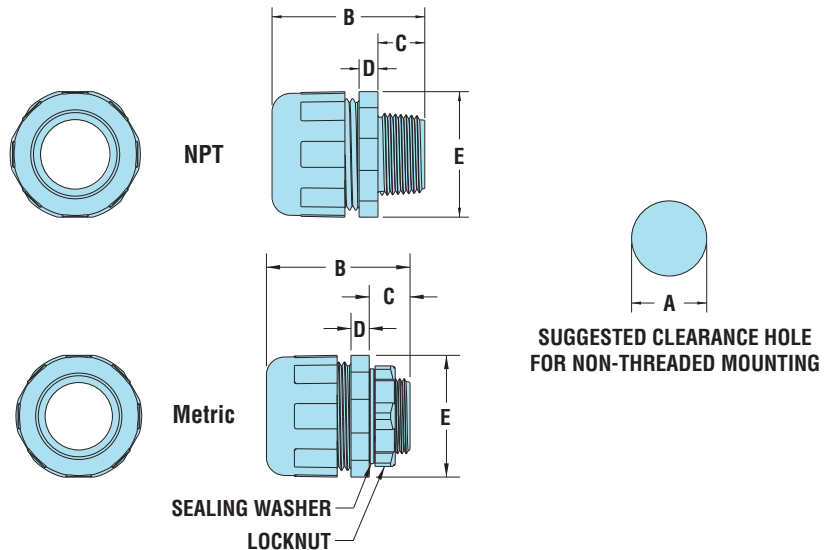

Quick
Specs

Material	Nylon 6/6 with Silicone Rubber Glands
Certifications	Recognized under the Component Program of Underwriters' Laboratories File E121095 to both U.S. and Canadian requirements
Flammability Rating	94V-2, 94V-0
Temperature Range	-22°F (-30°C) to 221°F (105°C)
IP Rating	IP 66

“Stay Connected” with



Liquid Tight Conduit, Tubing & Fittings

a PennEngineering® Company



Heyco® Nylon Conduit Fittings - 90° Sweep Fittings

For Flexible, Corrugated Nylon Conduit/Tubing

FITS CONDUIT SIZE	PART NO.		DESCRIPTION	THREAD SIZE	PART DIMENSIONS - BODY AND SEALING NUT							
	Black	V-0 Black			A Clearance Hole in. mm.		B Max O.A. Height in. mm.		C Max O.A. Length in. mm.		D Thread Length in. mm.	
NPT Hubs												
10 mm	H8601	H8601F	HPASC 1/4 NPT-90-10mm	1/4 NPT	.540	13,7	1.22	31,0	2.17	55,0	.45	11,4
13 mm	H8603	H8603F	HPASC 3/8 NPT-90-13mm	3/8 NPT	.680	17,3	1.38	35,0	2.44	62,0	.49	12,5
16 mm	H8604	H8604F	HPASC 3/8 NPT-90-16mm	3/8 NPT	.680	17,3	1.66	42,2	2.56	65,0	.50	12,7
	H8606	H8606F	HPASC 1/2 NPT-90-16mm	1/2 NPT	.875	22,2	1.66	42,2	2.64	67,0	.62	15,8
21 mm	H8610	H8610F	HPASC 1/2 NPT-90-21mm	1/2 NPT	.875	22,2	1.75	44,5	2.64	67,0	.62	15,8
28 mm	H8616	H8616F	HPASC 3/4 NPT-90-28mm	3/4 NPT	1.109	28,1	2.05	52,0	2.99	76,0	.63	16,0
34 mm	H8620	H8620F	HPASC 1 NPT-90-34mm	1 NPT	1.375	34,9	2.30	58,5	3.58	91,0	.77	19,6
42 mm	H8622	H8622F	HPASC 1-1/4 NPT-90-42mm	1-1/4 NPT	1.734	44,0	3.21	81,5	4.53	115,0	.79	20,1
	H8624	H8624F	HPASC 1-1/2 NPT-90-42mm	1-1/2 NPT	1.984	50,4	3.21	81,5	4.72	120,0		
54 mm	H8628	H8628F	HPASC 2 NPT-90-54mm	2 NPT	2.469	62,7	3.43	87,1	4.92	125,0	.80	20,3
Metric Hubs												
10 mm	H8670	H8670F	HPASC M12-90-10mm	M12	.473	12,0	1.22	31,0	2.17	55,0	.45	11,4
13 mm	H8672	H8672F	HPASC M16-90-13mm	M16	.630	16,0	1.38	35,0	2.44	62,0	.49	12,5
16 mm	H8674	H8674F	HPASC M16-90-16mm	M16	.630	16,0	1.65	42,0	2.56	65,0	.50	12,5
	H8676	H8676F	HPASC M20-90-16mm	M20	.787	20,0	1.65	42,0	2.64	67,0	.61	15,5
21 mm	H8680	H8680F	HPASC M20-90-21mm	M20	.787	20,0	1.73	44,0	2.64	67,0	.61	15,5
28 mm	H8686	H8686F	HPASC M25-90-28mm	M25	.984	25,0	2.05	52,0	2.99	76,0	.63	16,0
34 mm	H8690	H8690F	HPASC M32-90-34mm	M32	1.260	32,0	2.31	58,7	3.58	91,0	.77	19,6
42 mm	H8692	H8692F	HPASC M40-90-42mm	M40	1.575	40,0	3.20	81,3	4.53	115,0	.76	19,3
	H8694	H8694F	HPASC M50-90-42mm	M50	1.969	50,0	3.20	81,3	4.72	120,0	.63	16,0
54 mm	H8698	H8698F	HPASC M63-90-54mm	M63	2.480	63,0	3.42	86,9	4.92	125,0	.63	16,0

Standard color black.

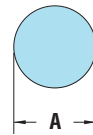
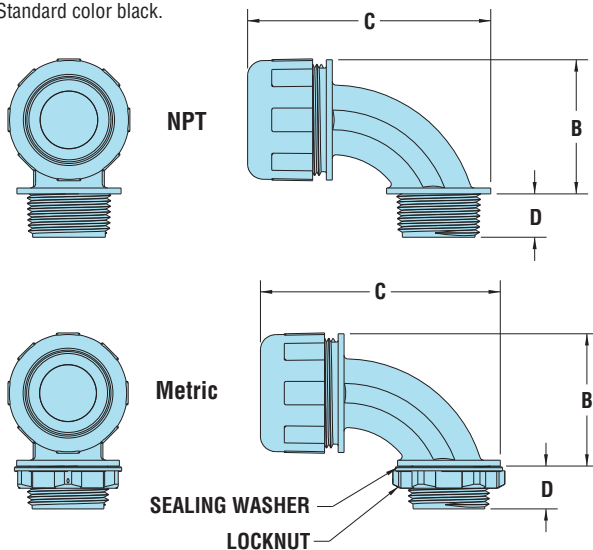

SUGGESTED CLEARANCE HOLE FOR NON-THREADED MOUNTING

- No disassembly required. Instead the installer simply pushes the conduit or tubing into the fitting, then tightens the domed sealing nut.
- Silicone sealing gland ensures liquid-tight seal.
- No threading of the conduit or tubing is required to install. This eliminates the possibility of cutting the conduit and creating leak paths.
- Multiple sizes available for use with Heyco-Flex Conduit and Tubing. See page 2-3.

Material	Nylon 6/6 with Silicone Rubber Glands
Certifications	cULus Recognized under the Component Program of Underwriters' Laboratories File E121095 to both U.S. and Canadian requirements
Flammability Rating	94V-2, 94V-0
Temperature Range	-22°F (-30°C) to 221°F (105°C)
IP Rating	IP 66

Quick Specs

"Stay Connected" with



Liquid Tight Conduit, Tubing & Fittings

a PennEngineering® Company



Heyco-Flex™ I Liquid Tight Conduit

Flexible, Nonmetallic Liquid Tight Electrical Conduit

- Smooth inside for easier wire pulling; no hazardous sharp edges or burrs; will not damage conductors.
- Lightweight and lower installed cost.
- Integral rigid and flexible PVC construction.
- Use with nylon Heyco-Flex Connectors; Straight, Snap-in, or Sweep. See pages 2-9 to 2-11.
- Also use with NPT Quick Twist Fittings. See pages 2-13 and 2-14.
- May also be used with Heyco's Metallic Fittings for Liquid Tight Conduit. See page 2-12.
- Resists corrosion, abrasion, oil, water, acid, metal shavings, and rough environments.
- Resists abuse, pull, and crushing.
- Approved for direct burial.
- Sunlight resistant.
- Suitable for indoor/outdoor use:
 - HVAC Equipment
 - Machine Tools
 - Marine Equipment
 - Motors and Controls
 - Printing Equipment
 - Pumps
 - Refrigeration Equipment
- Temperature ratings:
 - 80°C (176°F) DRY
 - 70°C (158°F) OIL Resistance
 - 60°C (140°F) WET locations
- Passes submersion test of 70 psi.
- **Voltage rating: 600V.**
- **Mounting brackets are available, see page 2-19.**
- **Order Part No. 8340, HF-28 Cutting Tool, for cutting Heyco-Flex conduit and tubing cleanly and evenly. See page 2-8.**

TRADE SIZE	PART NO.		DESCRIPTION	PART DIMENSIONS				STANDARD COIL LENGTH*
	Gray	Black		A		B		
				Outside Diameter	mm.	Inside Diameter	mm.	
3/8	8430	8430B	HF1 3/8	.70	17,8	.49	12,5	100
1/2	8431	8328	HF1 1/2	.83	21,1	.63	16,1	
3/4	8432	8432B	HF1 3/4	1.04	26,4	.83	21,1	
1	8433	8433B	HF1 1	1.30	33,1	1.05	26,8	
1-1/4	8434	8434B	HF1 1-1/4	1.65	41,8	1.40	35,4	
1-1/2	8435	8435B	HF1 1-1/2	1.88	47,8	1.59	40,3	50
2	8436	8436B	HF1 2	2.36	59,9	2.03	51,6	

Standard color gray. Consult Heyco for black and other colors.

*Consult Heyco for Cut to Length Availability.

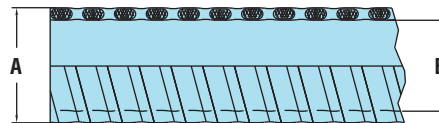

Material	PVC
Certifications	<ul style="list-style-type: none"> UL Listed under Underwriters' Laboratories File E121096 CSA Certified by Canadian Standards Association File 233010
Flammability Rating	VW1
Temperature Range	-4°F (-18°C) to 167°F (75°C)

Heyco-Flex™ I Female Conduit Adapters

For Heyco Liquid Tight Cordgrips and other NPT Hub Components

TRADE SIZE	PART NO.	DESCRIPTION
	Gray	
1/2	8658	FCA 1/2
3/4	8659	FCA 3/4
1	8660	FCA 1
1-1/4	8661	FCA 1-1/4
1-1/2	8662	FCA 1-1/2
2	8663	FCA 2

- Cement onto HF1 Conduit and **convert the rough cut end into an NPT threaded hub.**
- Allow for the installation of Heyco Liquid Tight Cordgrips (Section 3) as well as other NPT hub parts, onto the end of Heyco-Flex I Conduit.
- **Solar App:** The solar installer can run PV conductors through a **Heyco Solar Masthead/Heyco Flex I assembly**, using a Female Conduit Adapter, from the roof to the field level inverter.



Quick Specs

Material Schedule 80 PVC

“Stay Connected” with



Liquid Tight Conduit, Tubing & Fittings

a PennEngineering® Company

Heyco-Flex™ II Liquid Tight Tubing

Flexible, Nonmetallic Liquid Tight Electrical Tubing

TRADE SIZE	PART NO. Black	DESCRIPTION	PART DIMENSIONS				STANDARD COIL LENGTH ft/coil
			A Outside Diameter		B Inside Diameter		
			in.	mm.	in.	mm.	
1/4	8449	HF2 1/4	.57	14,4	.40	10,0	100
3/8	8450	HF2 3/8	.70	17,8	.49	12,5	
1/2	8451	HF2 1/2	.83	21,1	.63	16,1	
3/4	8452	HF2 3/4	1.04	26,4	.83	21,1	
1	8453	HF2 1	1.30	33,1	1.05	26,8	
1-1/4	8454	HF2 1-1/4	1.65	41,8	1.40	35,4	50
1-1/2	8455	HF2 1-1/2	1.88	47,8	1.59	40,3	
2	8456	HF2 2	2.36	59,9	2.03	51,6	

Standard color black.
Consult Heyco for Cut to Length Availability.



- Maximum flexibility; can be used in extremely tight quarters.
- Smooth inside for easier wire pulling.
- Lightweight and lower installed cost.
- Integral rigid and flexible PVC construction.
- Use with nylon Heyco-Flex Connectors: Straight, Snap-in, or Sweep. See pages 2-9 to 2-11.
- Also use with Quick Twist Fittings. See pages 2-13 and 2-14.
- 1/4" thru 2" trade sizes.
- Resists corrosion, oil, and water.
- UV resistant.
- Suitable for use in high vibration or flexing applications:
 - Automotive Equipment
 - Computers and Peripherals
 - Fiber Optics
 - Lab Equipment
 - Lasers
 - Office Equipment
 - Processing Control and Monitoring Equipment
 - Robotics
 - White Goods
- Passes submersion test of 70 psi.
- **Voltage Rating: 300V.**
- **Mounting brackets are available, see page 2-19.**
- **Order Part No. 8340, HF-28 Cutting Tool, for cutting Heyco-Flex tubing and conduit cleanly and evenly.**

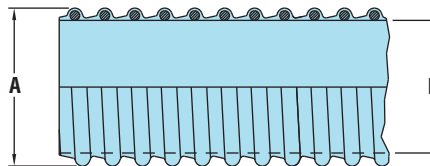

Material
Certifications

PVC
 Recognized under the Component Program of Underwriters' Laboratories File E121095
 Certified by Canadian Standards Association File 233010
 Flammability Rating VW1
 Temperature Range -4°F (-18°C) to 158°F (70°C)

Quick
Specs



Heyco-Flex™ Liquid Tight Conduit Fittings

For Flexible, Nonmetallic Liquid Tight Heyco-Flex™ I Conduit and Heyco-Flex™ II Tubing Straight-Thru, NPT Hubs

- No disassembly required. Instead, the installer simply pushes the conduit or tubing onto the ferrule, then tightens the domed sealing nut. This completed assembly can then be secured in the panel by the locknut or into an NPT threaded hole.
- Convex ferrule ensures liquid tight seal.
- No threading of the conduit or tubing is required to install. This eliminates the possibility of cutting the conduit and creating leak paths.
- Complete conduit/connector system is reusable. Conduit will not wind tight onto the connector during assembly and can be easily removed by pulling while turning in a clockwise direction.
- Multiple sizes for use with Heyco-Flex Conduit and Tubing. See pages 2-7 and 2-8.
- Suitable for indoor/outdoor use; for original equipment manufacturers or field installers.
- Use of a sealing washer may be required for wet locations. See page 2-19.
- All nylon construction resists salt water, weak acids, gasoline, alcohol, oil, grease, and common solvents. (This feature is not assessed by UL certification and testing.)
- If using a tapped hole, Teflon® tape is needed on the threads of the connector, for all other applications an O-ring and Locknut are needed to attain liquid tight.
- Black connectors up to 1" provided with nylon locknut, packed separately. O-ring sold separately, see page 2-20.
- Black connectors larger than 1" and all gray connectors provided with assembled O-ring and metal locknuts.
- See pages 2-17 and 2-18 for locknuts.

FITS CONDUIT/TUBING TRADE SIZE	PART NO.		DESCRIPTION	THREAD SIZE	PART DIMENSIONS BODY AND SEALING UNIT									
	Black	Gray			A		B		C		D		E	
					Clearance Hole	in.	mm.	Max. O.A. Length	in.	mm.	Thread Length	in.	mm.	Nut Thk.
1/4	8398	-	HFC 1/4-PG7*	PG7	.492	12,5	1.13	28,7	.45	11,4	.21	5,3	1.00	25,4
3/8	8400	8401	HFC 3/8	1/2" NPT	.875	22,2	1.96	49,8	.63	16,0	.25	6,3	1.33	33,7
1/2	8402	8403	HFC 1/2		**									
3/4	8404	8405	HFC 3/4	3/4" NPT	1.109	28,1	2.04	52,8	.63	16,0	.25	6,3	1.56	39,6
1	8406	8407	HFC 1	1" NPT	1.375	34,9	2.25	57,2	.78	19,8	.25	6,3	1.81	46,0
1-1/4	8638	8639	HFC 1-1/4	1-1/4" NPT	1.734	44,0	2.07	52,6	.69	17,4	.25	6,3	2.15	54,6
1-1/2	8640	8641	HFC 1-1/2	1-1/2" NPT	1.984	50,4	2.28	57,9	.78	19,8	.28	7,0	2.40	61,0
2	8642	8643	HFC 2	2" NPT	2.469	62,7	2.26	66,0	.85	21,6	.31	7,9	2.98	75,6

Standard colors black and gray.

*Standard color black. Recognized under UL file E121095. For PG 7 thread specification, see page 3-57.

**Fittings use same mounting hole size but attach two different conduit sizes.

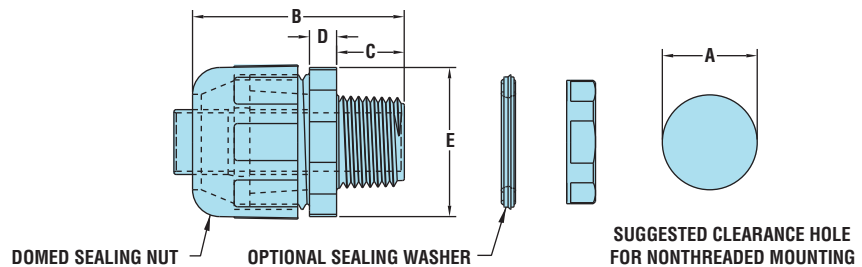
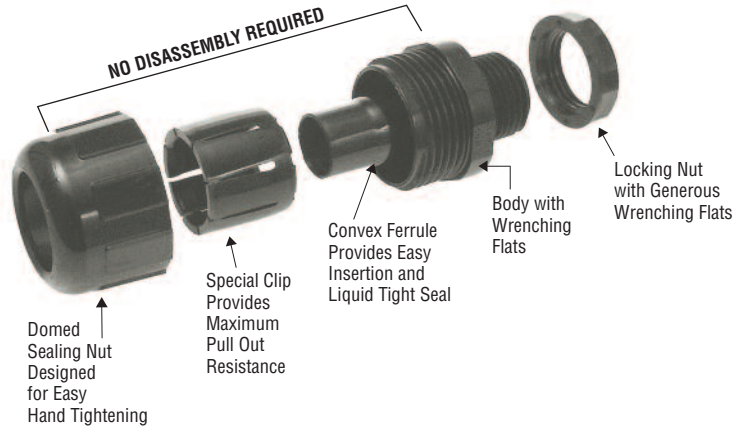

Material	Nylon 6/6
Certifications	<ul style="list-style-type: none"> UL Listed under Underwriters' Laboratories File E28430 CSA Certified by Canadian Standards Association File 84579 and 81067
Flammability Rating	94V-2
Temperature Range	-22°F (-30°C) to 221°F (105°C)
IP Rating	IP 68 up to 70 psi (5 bar) water pressure

“Stay Connected” with



Liquid Tight Conduit, Tubing & Fittings

a PennEngineering® Company

Heyco-Flex™ Liquid Tight Conduit Fittings

For Flexible, Nonmetallic Liquid Tight Heyco-Flex™ I Conduit and Heyco-Flex™ II Tubing
Straight-Thru, Snap-In Hubs

FITS CONDUIT/ TUBING TRADE SIZE	PART NO.	DESCRIPTION	PART DIMENSIONS									
			A		B		C		D		E	
			Mounting Hole Dia.		Max O.A. Length		Body Length		Wrenching Nut Thk.		Flat Size	
			in.	mm.	in.	mm.	in.	mm.	in.	mm.	in.	mm.
1/4	8382	HFC 1/4-S	.500	12,7	1.50	38,1	.45	11,3	.22	5,6	.88	22,2
3/8	8384	HFC 3/8-S	.875	22,2	2.00	50,8	.63	15,9	.25	6,3	1.33	33,7
1/2	8386	HFC 1/2-S										
3/4	8388	HFC 3/4-S	1.090	27,7	2.03	51,6	.63	15,9	.25	6,3	1.56	39,7
1	8390	HFC 1-S	1.375	34,9	2.25	57,1	.78	19,8	.25	6,3	1.81	46,0

Standard color black.

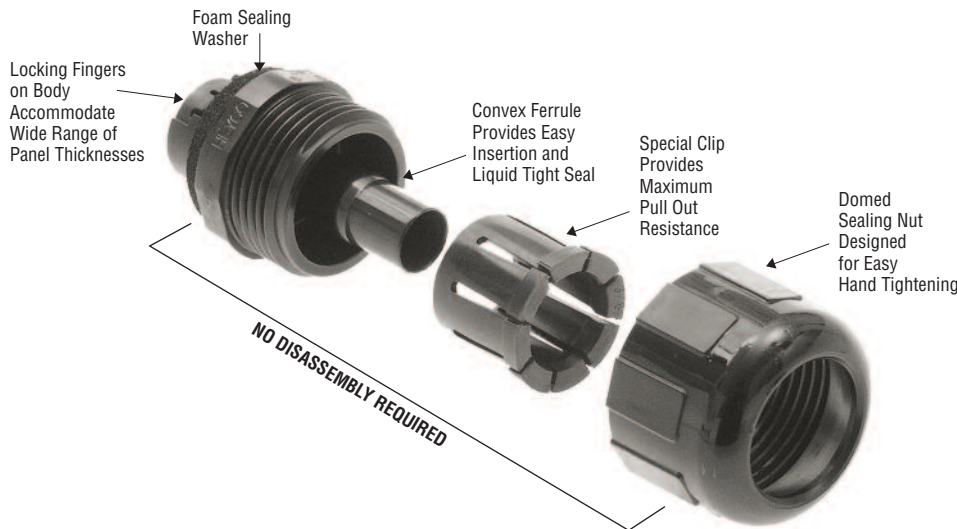
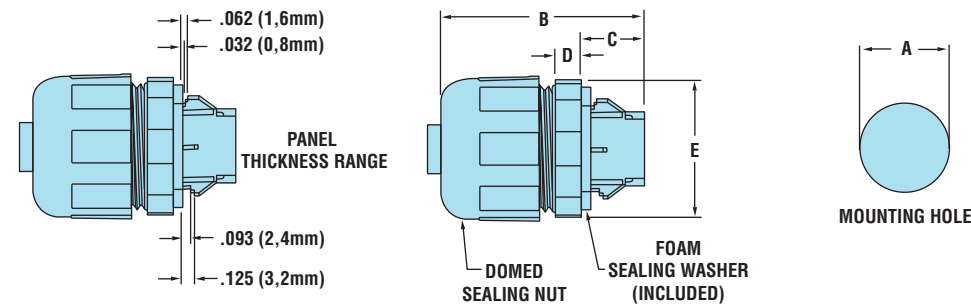

- Assembly friendly! The installer simply pushes the conduit or tubing onto the ferrule, then tightens the domed sealing nut. This completed assembly can then be snapped into the panel with fingertip pressure.
- Convex ferrule ensures liquid tight seal.
- No threading of the conduit or tubing required to install. This eliminates the possibility of cutting the conduit and creating leak paths.
- Complete conduit/fitting system is reusable. Conduit will not wind tight onto the connector during assembly and can be easily removed by pulling while turning in a clockwise direction.
- Multiple sizes for use with Heyco-Flex Conduit and Tubing. See pages 2-7 and 2-8.
- Suitable for indoor/outdoor use; for original equipment manufacturers or field installers.
- Resist salt water, weak acids, gasoline, alcohol, oil, grease, and common solvents. (This feature is not assessed by UL certification or testing.)
- Foam sealing washer **included**.

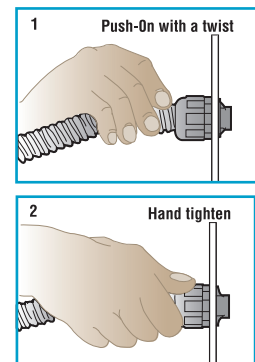

Material	Nylon 6/6
Certifications	<ul style="list-style-type: none"> UL Listed under Underwriters' Laboratories File E28430 SP Certified by Canadian Standards Association File 84579 and 81067
Flammability Rating	94V-2
Temperature Range	-22°F (-30°C) to 221°F (105°C)
IP Rating	IP 68 up to 70 psi (5 bar) water pressure

Quick Specs



Heyco-Flex™ Liquid Tight Conduit Fittings

For Flexible, Nonmetallic Liquid Tight Heyco-Flex™ I Conduit and Heyco-Flex™ II Tubing
90° Sweep, NPT Hubs

- Smooth internal surfaces for easier wire installation around corner angles.
- No disassembly required. Instead, the installer simply pushes the conduit or tubing onto the ferrule, then tightens the domed sealing nut. This completed assembly can then be secured in the panel by the locknut or into an NPT threaded hole.
- Convex ferrule ensures liquid tight seal.
- No threading of the conduit or tubing is required to install. This eliminates the possibility of cutting the conduit and creating leak paths.
- Complete conduit/connector system is reusable. Conduit will not wind tight onto the connector during assembly and can be easily removed by pulling while turning in a clockwise direction.
- Lower installed cost.
- Multiple sizes for use with Heyco-Flex Conduit and Tubing. See pages 2-7 and 2-8.
- Suitable for indoor/outdoor use; for original equipment manufacturers or field installers.
- Resist salt water, weak acids, gasoline, alcohol, oil, grease, and common solvents. (This feature is not assessed by UL certification and testing.)
- Use of a sealing washer may be required for wet locations. See pages 2-19.
- If using a tapped hole, Teflon® tape is needed on the threads of the connector, for all other applications an O-ring and Locknut are needed to attain liquid tight.
- Black connectors up to 1” provided with nylon locknut, packed separately. O-ring sold separately, see page 2-20.
- Black connectors larger than 1” and all gray connectors provided with assembled O-ring and metal locknut.
- See pages 2-17 and 2-18 for locknuts.

FITS CONDUIT/TUBING TRADE SIZE	PART NO.		DESCRIPTION	THREAD SIZE	PART DIMENSIONS BODY AND SEALING UNIT							
	Black	Gray			A Clearance Hole		B Max. O.A. Height		C Max. O.A. Length		D Thread Length	
					in.	mm.	in.	mm.	in.	mm.	in.	mm.
3/8	8423	8424	HFC 3/8-90R	1/2 NPT	.875	22,2	1.98	50,3	2.91	73,9	.52	13,2
1/2	8425	8426	HFC 1/2-90R		1.109	28,1	2.29	58,2	3.17	80,5	.52	13,2
3/4	8427	8428	HFC 3/4-90R	3/4 NPT	1.375	34,9	2.83	71,9	3.96	100,6	.69	17,5
1	8412	8413	HFC 1-90R	1 NPT	1.734	44,0	4.10	104,1	4.73	104,1	.76	19,3
1-1/4	8652	8653	HFC 1-1/4-90R	1-1/4 NPT	1.984	50,4	4.75	120,7	5.20	132,1	.80	20,3
1-1/2	8654	8655	HFC 1-1/2-90R	1-1/2 NPT	2.469	62,7	5.42	137,7	5.80	147,3	.86	21,8
2	8656	8657	HFC 2-90R	2 NPT								

Standard colors black and gray.

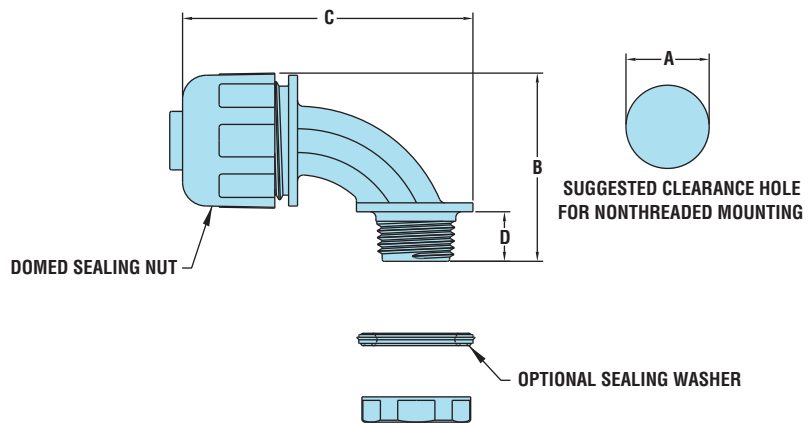

Quick Specs

Material
Certifications

Nylon 6/6

UL Listed under Underwriters' Laboratories File E28430

CS Certified by Canadian Standards Association File 84579 and 81067

Flammability Rating

94V-2

Temperature Range

-22°F (-30°C) to 221°F (105°C)

IP Rating

IP 68 up to 70 psi (5 bar) water pressure

"Stay Connected" with



Liquid Tight Conduit, Tubing & Fittings

a PennEngineering® Company



Heyco-Flex™ Metallic Liquid Tight Conduit Fittings

For use with Nonmetallic Heyco-Flex™ I Electrical Conduit

Straight-Thru, NPT Hubs

FITS CONDUIT/ TUBING TRADE SIZE	PART NO.	DESCRIPTION	PART DIMENSIONS BODY AND SEALING UNIT									
			A Clearance Hole		B Max. O.A. Length		C Thread Length		D Nut Thk.		E Wrenching Flat Size	
			in.	mm.	in.	mm.	in.	mm.	in.	mm.	in.	mm.
	9794	HFC-Z 1/2	.890	22,6	1.27	32,3	.49	12,3	.16	4,1	1.19	30,1
NEW!	9795	HFC-Z 3/4	1.109	28,1	1.37	34,8	.50	12,6	.19	4,7	1.50	38,1
	9793	HFC-Z 1	1.375	34,9	1.67	42,4	.58	14,7	.16	4,1	1.69	42,9

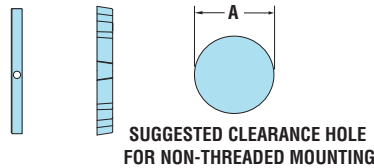
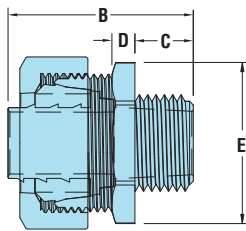

- Cost effective die-cast zinc construction provides durability and resists rough environments.
- Liquid Tight when used with Heyco-Flex™ I Liquid Tight Conduit. See Page 2-7.
- Provide smooth connection, no sharp edges to strip wire.
- Suitable for outside, inside, and industrial uses including transformer connections, air conditioning, and heating.
- Suitable for use in both wet and dry location.
- Fit the most common sizes of nonmetallic liquid tight conduit.
- If using a tapped hole, Teflon® tape is needed on the threads of the connector, for all other applications an O-ring and Locknut are needed to attain liquid tight.
- Supplied with locknut and plastic sealing ring.
- DFARS Compliant

90° Sweep, NPT Hubs

FITS CONDUIT/ TUBING TRADE SIZE	PART NO.	DESCRIPTION	PART DIMENSIONS BODY AND SEALING UNIT											
			A Clearance Hole		B Max. O.A. Length		C Max. O.A. Height		D Thread Length		E Wrenching Nut Thk.		F Flat Size	
			in.	mm.	in.	mm.	in.	mm.	in.	mm.	in.	mm.	in.	mm.
1/2	9796	HFC-Z 1/2-90	.890	22,6	2.346	59,6	2.118	53,8	.515	13,1	.105	2,9	1.135	28,8

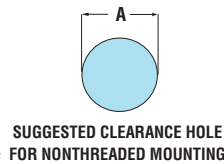
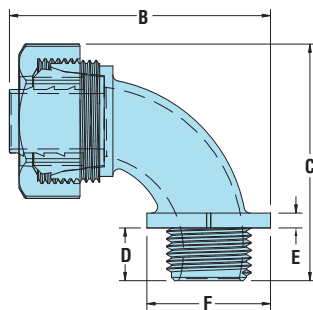

Material
Certifications

Die cast zinc
 Listed under UL File E103541

Quick
Specs

“Stay Connected” with



Liquid Tight Conduit, Tubing & Fittings

a PennEngineering® Company



Heyco-Flex™ Quick Twist Conduit Fittings

For use with Heyco-Flex™ I and II Conduit and Tubing
Straight-Thru, Snap-In and NPT Hubs

- One-piece solution with smooth internal surfaces provides for easier wire routing, protection, and installation.
- Easy, permanent assembly: the installer twists the tubing over the connector ferrule.
- Unique locking fingers accommodate various panel thicknesses.
- All nylon construction is resistant to salt water, weak acids, gasoline, alcohol, oil, grease, and common solvents. (This feature is not assessed by UL certification and testing.)
- Suitable for a wide array of electrical applications:
 - Commercial and Industrial HVAC Systems
 - Motorized Equipment
 - Enclosed Power Sources
 - Garage Door Openers
 - Major Appliances
- Finishing collars available to neaten rough cut tubing ends.
- Assembly Tool available for assembling Quick Twist Fittings into HF1 and HF2 Conduit and Tubing (see page 2-14)

Snap-In Hubs

- Snap-in Fittings are UL recognized for use with Heyco-Flex II Tubing.
- Suitable for dry location only.

NPT Hubs

- NPT threaded fittings are UL approved for use with Heyco-Flex I & II Conduit and Tubing.
- If using a tapped hole, Teflon® tape is needed on the threads of the connector, for all other applications an O-ring and Locknut are needed to attain liquid tight.
- **Locknuts not included.** To order nylon or metal locknuts separately, see pages 2-17 and 2-18.
- See page 2-20 for O-Rings.

FITS TUBING TRADE SIZE	PART NO.			DESCRIPTION	PART DIMENSIONS									
	Black	Black w/ Finishing Collar*	Gray		A Mounting Hole Dia.		B Overall Length		C Body Length		D Wrenching Nut Thickness		E Wrenching Nut Flat Size	
					in.	mm.	in.	mm.	in.	mm.	in.	mm.	in.	mm.

Snap-In Hubs - For use with Heyco-Flex™ II Tubing

1/4	8515	–	8516	HFC 1/4-S-Twist	.540	13,7	1.33	33,8	.34	8,7	.09	2,3	.75	19,1
3/8	8485	8485FC	8486	HFC 3/8-S-Twist	.875	22,2	1.38	35,0	.39	9,9	.09	2,3	1.00	25,4
1/2	8490	8490FC	8491	HFC 1/2-S-Twist										
3/4	8495	8495FC	8496	HFC 3/4-S-Twist	1.109	28,2	1.50	38,0	.39	9,9	.09	2,3	1.25	31,8

NPT Hubs - For use with Heyco-Flex™ I and II Conduit and Tubing

1/4	8517	–	8518	HFC 1/4-Twist	.540	13,7	1.56	39,6	.47	11,8	.20	5,1	.75	19,1
3/8	8487	8487FC	8488	HFC 3/8-Twist	.875	22,2	1.72	43,7	.63	15,9	.20	5,1	1.18	30,0
1/2	8493	8493FC	8494	HFC 1/2-Twist										
3/4	8497	8497FC	8498	HFC 3/4-Twist	1.109	27,8	1.84	46,7	.63	15,9	.20	5,1	1.37	34,8

Standard colors black and gray.

*Collar not assembled.

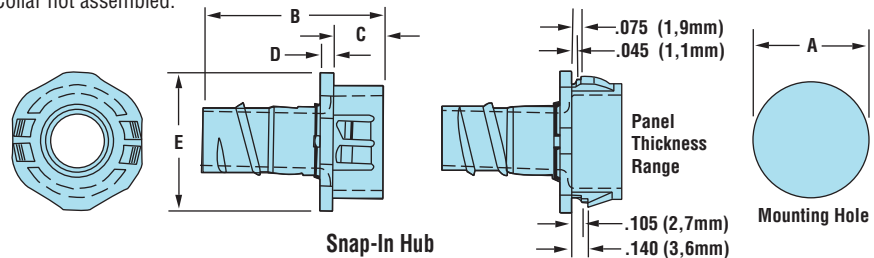

NPT Hub

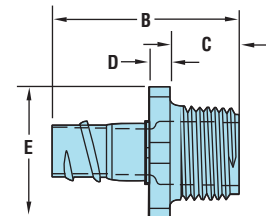
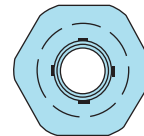

SU

Heyco-Flex™ Quick Twist Finishing Collars

For use with Heyco-Flex™ I and II Conduit



FITS CONDUIT/ TRADE SIZE	PART NO.		DESCRIPTION
	Black	Gray	
3/8	8474	8482	HFC TWIST 3/8 COLLAR
1/2	8475	8483	HFC TWIST 1/2 COLLAR
3/4	8476	8484	HFC TWIST 3/4 COLLAR

Standard colors black and gray. Consult Heyco for other colors. (Not available in 1/4”).

Material	Nylon 6/6
Certifications	Recognized under the Component Program of Underwriters' Laboratories File E121095 (Snap-in Hubs) UL Listed under Underwriters' Laboratories File E28430 (NPT Hubs)
Flammability Rating	94V-2
Temperature Range	-22°F (-30°C) to 221°F (105°C)

Heyco-Flex™ Quick Twist Conduit Fittings

For use with Heyco-Flex™ I and II Conduit and Tubing
90° Sweep, Snap-In and NPT Hubs

FITS TUBING TRADE SIZE	PART NO.		DESCRIPTION	PART DIMENSIONS									
	Black	Gray		A		B		C		D		E	
				Mounting Hole Dia.	Max O.A. Height	Max O.A. Length	Hub Length	Flange Dia.	in.		mm.		
Snap-In Hubs - For use with Heyco-Flex™ II Tubing only													
3/8	8500	8501	HFC 3/8-S-90-Twist	.875	22,2	1.75	44,6	2.75	69,8	.39	9,9	1.23	31,2
1/2	8505	8506	HFC 1/2-S-90-Twist	1.109	28,2	1.97	50,0	3.08	78,3	.39	9,9	1.50	38,1
3/4	8510	8511	HFC 3/4-S-90-Twist	1.109	28,2	2.11	53,5	3.08	78,3	.53	13,5	1.50	38,1
NPT Hubs - For use with Heyco-Flex™ I and II Conduit and Tubing													
3/8	8502	8503	HFC 3/8-90-Twist	.875	22,2	1.75	44,6	2.75	69,8	.51	13,2	1.23	31,2
1/2	8507	8508	HFC 1/2-90-Twist	1.109	28,2	2.11	53,5	3.08	78,3	.53	13,5	1.50	38,1

Standard colors black and gray. Consult Heyco for other colors.

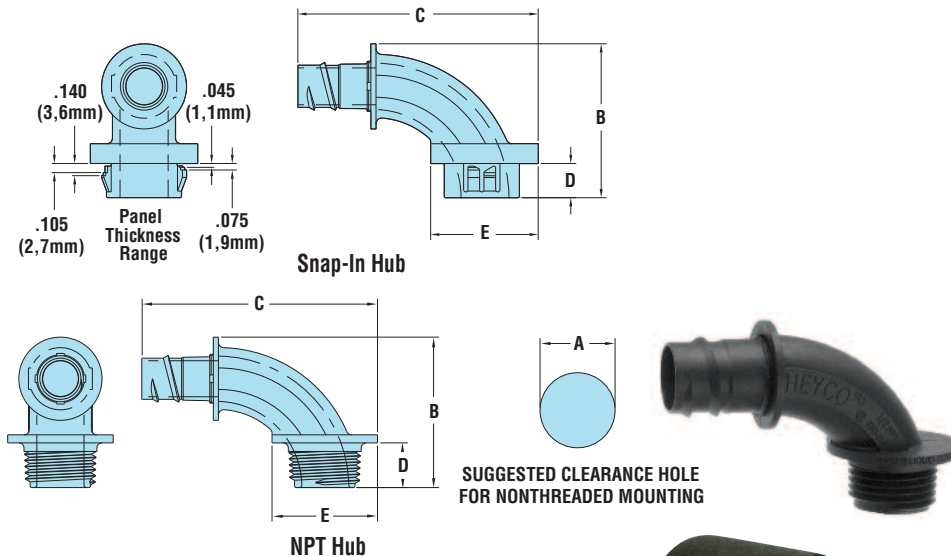

Heyco® Quick Twist Assembly Tool

For use with Heyco-Flex™ Quick Twist Fittings

PART NO.	THREAD SIZE	Hub Type
0055	3/8 & 1/2	Snap-In
0056	3/4	
0057	3/8 & 1/2	NPT
0058	3/4	

Material	Nylon 6/6
Certifications	Recognized under the Component Program of Underwriters' Laboratories File E121095 (Snap-in Hubs) UL Listed under Underwriters' Laboratories File E28430 (NPT Hubs)
Flammability Rating	94V-2
Temperature Range	-22°F (-30°C) to 221°F (105°C)



- One-piece solution with smooth internal surfaces provides for easier wire routing, protection, and installation around corner angles.
- Easy, permanent assembly: the installer twists the tubing over the connector ferrule.
- Unique locking fingers accommodate various panel thicknesses.
- All nylon construction is resistant to salt water, weak acids, gasoline, alcohol, oil, grease, and common solvents. (This feature is not assessed by UL certification and testing.)
- Suitable for a wide array of electrical applications:
 - Commercial and Industrial HVAC Systems
 - Motorized Equipment
 - Enclosed Power Sources
 - Garage Door Openers
 - Major Appliances
- Finishing collars available to neaten rough cut tubing ends (see page 2-13).
- Assembly Tool available for assembling Quick Twist Fittings into HF1 and HF2 Conduit and Tubing.

Snap-In Hubs

- Snap-in Fittings are UL recognized for use with Heyco-Flex II Tubing.
- Suitable for dry location only.

NPT Hubs

- NPT threaded fittings are UL approved for use with Heyco-Flex I & II Conduit and Tubing.
- If using a tapped hole, Teflon® tape is needed on the threads of the connector, for all other applications an O-ring and Locknut are needed to attain liquid tight.
- **Locknuts not included.** To order nylon or metal locknuts separately, see pages 2-17 and 2-18.
- See page 2-20 for O-Rings.

Quick
Specs



Heyco-Flex™ VI Liquid Tight Conduit

Flexible, PVC/Metal Liquid Tight Electrical Conduit (LFMC)

- Constructed of PVC jacketed, continuously interlocked hot dipped zinc galvanized steel core for exceptional crush and corrosion resistance.
- Used with standard liquid-tight fittings (page 2-16) for easy installation.
- IP 67 Rated when installed with approved connectors.
- Durable, sunlight resistant and flame retardant thermoplastic PVC jacket that resists heat, oil, and chemical breakdown.
- Approved for both exposed and concealed locations, direct burial and in concrete.
- Approved as an equipment grounding conductor if the total grounding path is 6 ft. or less and the circuit conductors are protected by over 20 amps for 3/8" and 1/2" and 60 amps or less for 3/4" through 1-1/4".
- Suitable for use in hazardous locations per NEC Articles 501 Class I Div. 2, Article 502 Class II Div. 1 & 2, Article 503 Class III Div. 1 & 2.
- Complies with UL Standard 360 File No. E18917; CSA C22.2 File No. 158897; and NEC Article 350.
- DFARS Compliant

TRADE SIZE	PART NO. Gray	DESCRIPTION	PART DIMENSIONS				STANDARD COIL LENGTH ft/coil
			A Outside Diameter		B Inside Diameter		
			in.	mm.	in.	mm.	
3/8	8457	HF6 3/8 LFMC	.70	17,8	.49	12,5	100
1/2	8458	HF6 1/2 LFMC	.83	21,1	.63	16,1	
3/4	8459	HF6 3/4 LFMC	1.04	26,4	.83	21,1	
1	8460	HF6 1 LFMC	1.30	33,1	1.04	26,4	

Standard color gray. Consult Heyco for black and other colors.

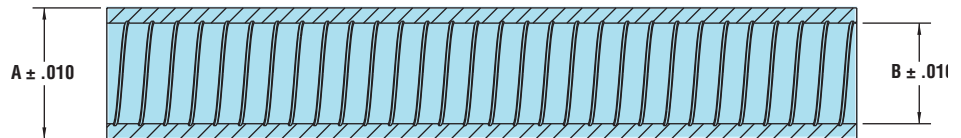

Quick
Specs

Material	PVC jacket with zinc galvanized steel core
Certifications	Listed under the Component Program of Underwriters' Laboratories File E469210 Certified by Canadian Standards Association File 260992
Temperature Range	-4°F (-20°C) to 140°F (60°C)



Heyco-Flex™ VI Liquid Tight Conduit Fittings

Nickel-plated Brass Construction

Straight-Thru, NPT Hubs

TRADE SIZE	PART NO.	DESCRIPTION	PART DIMENSIONS									
			A Clearance Hole		B Max O.A. Length		C Thread Length		D Wrenching Nut Flat Size		E Wrenching Flat Size	
			in.	mm.	in.	mm.	in.	mm.	in.	mm.	in.	mm.
3/8	4028	HF6C 3/8	.874	22,2	1.38	35,0	.55	14,0	1.02	26,0	.95	24,0
1/2	4029	HF6C 1/2	.874	22,2	1.42	36,0	.55	14,0	1.14	29,0	1.06	27,0
3/4	4030	HF6C 3/4	1.040	26,4	1.46	37,0	.55	14,0	1.38	35,0	1.30	33,0
1	4031	HF6C 1	1.327	33,7	1.58	40,0	.63	16,0	1.77	45,0	1.65	42,0

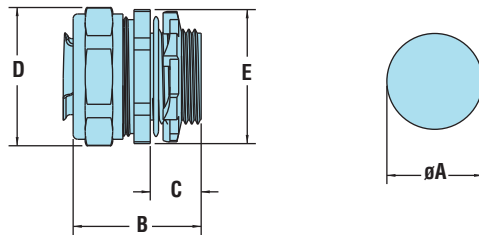

- Designed with an insulated throat to prevent wire damage during installation.
- Excellent corrosion resistance, strength, and durability.
- Connector is ideal for use with standard liquid-tight conduit to allow easy installation. IP 66/67 rated when installed with approved conduit.
- Approved for both exposed and concealed locations.
- Suitable for harsh industrial, food and beverage, petro-chemical, waste water, salt water, and other corrosive applications.
- Suitable for use in hazardous locations per NEC Articles 501 Class I Div. 2, Article 502 Class II Div. 1 & 2, Article 503 Class III Div. 1 & 2.
- Complies with UL Standard 360 File No. E18917; CSA C22.2 File No. 158897; and NEC Article 350.
- DFARS Compliant

90° Sweep, NPT Hubs

TRADE SIZE	PART NO.	DESCRIPTION	PART DIMENSIONS									
			A Clearance Hole		B Max O.A. Length		C Thread Length		D Wrenching Nut Flat Size		E Wrenching Flat Size	
			in.	mm.	in.	mm.	in.	mm.	in.	mm.	in.	mm.
3/8	4032	HF6C 3/8-90	.874	22,2	1.18	30,0	.55	14,0	1.02	26,0	.95	24,0
1/2	4033	HF6C 1/2-90	.874	22,2	1.38	32,0	.55	14,0	1.14	29,0	1.06	27,0
3/4	4034	HF6C 3/4-90	1.040	26,4	1.42	36,0	.55	14,0	1.38	35,0	1.30	33,0
1	4035	HF6C 1-90	1.327	33,7	1.93	49,0	.63	16,0	1.77	45,0	1.65	42,0

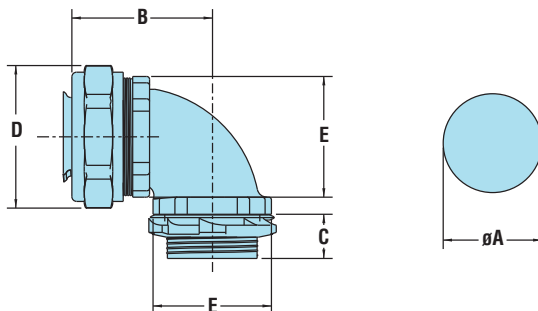

Material	Nickel Plated Brass with a PA6 clamping ring, galvanized steel ferrule and locknut and NBR rubber washer
Certifications	Certified by Underwriters' Laboratories for Compliance with both Canadian and U.S. requirements under File E234207
Temperature Range	-45°F (-45°C) to 221°F (105°C)

Quick Specs



• DFARS Compliant

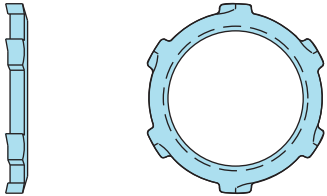

Stamped Steel Nut

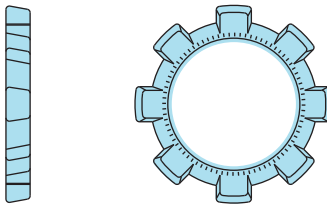

Zinc Die-cast Nut



Nickel-Plated Brass

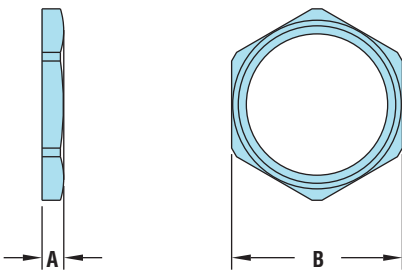

Heyco® Metal Locknuts

NPT Thread—Straight NPS Threads for use with NPT Threaded Fittings

THREAD TYPE AND SIZE	STAMPED STEEL		ZINC DIE-CAST	
	PART NO.	DESCRIPTION	PART NO.	DESCRIPTION
1/4 NPT	2238	LN 1/4*	-	-
3/8 NPT	2242	LN 3/8*	-	-
1/2 NPT	2250	LN 1/2	9800	LN 1/2 DC
3/4 NPT	2251	LN 3/4	9801	LN 3/4 DC
1 NPT	2252	LN 1	9802	LN 1 DC
1-1/4 NPT	9806	LN 1-1/4	9803	LN 1-1/4 DC
1-1/2 NPT	9807	LN 1-1/2	9804	LN 1-1/2 DC
2 NPT	9808	LN 2	9805	LN 2 DC
2-1/2 NPT	9809	LN 2-1/2	-	-
3 NPT	9810	LN 3	-	-

*Wrenching flats are not crenellated

PG Thread—Nickel-Plated Brass

THREAD TYPE AND SIZE	PART NO.	DESCRIPTION	PART DIMENSIONS			
			A Thickness		B Wrenching Flats	
			in.	mm.	in.	mm.
PG 7	2257	Brass LN PG 7	.110	2,8	.591	15,0
PG 9	2258	Brass LN PG 9	.110	2,8	.709	18,0
PG 11	2259	Brass LN PG 11	.118	3,0	.827	21,0
PG 13.5	2260	Brass LN PG 13	.118	3,0	.906	23,0
PG 16	2261	Brass LN PG 16	.118	3,0	1.024	26,0
PG 21	2262	Brass LN PG 21	.138	3,5	1.261	32,0
PG 29	2263	Brass LN PG 29	.158	4,0	1.615	41,0
PG 36	2268	Brass LN PG 36	.197	5,0	2.009	51,0
PG 42	2269	Brass LN PG 42	.197	5,0	2.364	60,0

Metric Thread—Nickel-Plated Brass

THREAD TYPE AND SIZE	PART NO.	DESCRIPTION	PART DIMENSIONS			
			A Thickness		B Wrenching Flats	
			in.	mm.	in.	mm.
M6 x 1	2243	Brass LN M6	.110	2,8	.354	9,0
M8 x 1,25	2244	Brass LN M8	.110	2,8	.433	11,0
M10 x 1,5	2245	Brass LN M10	.110	2,8	.512	13,0
M12 x 1,5	2246	Brass LN M12	.118	3,0	.591	15,0
M16 x 1,5	2247	Brass LN M16	.118	3,0	.748	19,0
M20 x 1,5	2248	Brass LN M20	.138	3,5	.945	24,0
M25 x 1,5	2249	Brass LN M25	.138	3,5	1.181	30,0
M32 x 1,5	2253	Brass LN M32	.177	4,5	1.417	36,0
M40 x 1,5	2254	Brass LN M40	.177	4,5	1.811	46,0
M50 x 1,5	2255	Brass LN M50	.217	5,5	2.165	55,0

Heyco® Nylon Locknuts

NPT Thread—Straight NPS Threads for use with NPT Threaded Fittings

THREAD TYPE AND SIZE	PART NO. BULK		PART NO. 100 PACK		DESCRIPTION	PART DIMENSIONS			
	Black	Gray	Black	Gray		A		B	
						Thickness	Wrenching Flats	in.	mm.
1/4 NPT	M9142	M9143	3269	3270	NLN 1/4 NPT	.265	6,7	.748	19,0
3/8 NPT	8461	8462	3271	3272	NLN 3/8 NPT	.265	6,7	1.058	26,9
1/2 NPT	8463	8464	3273	3274	NLN 1/2 NPT	.265	6,7	1.058	26,9
3/4 NPT	8465	8466	3275	3276	NLN 3/4 NPT	.265	6,7	1.295	32,9
1 NPT	8467	8468	3277	3278	NLN 1 NPT	.265	6,7	1.605	40,8
1-1/4 NPT	M9144	M9145	3279*	—	NLN 1-1/4 NPT	.281	7,1	1.968	50,0
1-1/2 NPT	M9150	M9151	—	—	NLN 1-1/2 NPT	.320	8,1	2.735	69,5
2 NPT	M9156	M9157	—	—	NLN 2 NPT	.375	9,5	2.835	72,0

Standard colors black or gray.
*PN 3279 is a 50 Pack.

PG Thread

THREAD TYPE AND SIZE	PART NO.		DESCRIPTION	PART DIMENSIONS			
	Black	Gray		A		B	
				Thickness	Wrenching Flats	in.	mm.
PG 7	3165	3166	NLN PG 7	.218	5,5	.750	19,1
PG 9	3167	3168	NLN PG 9	.218	5,5	.859	21,8
PG 11	3169	3170	NLN PG 11	.218	5,5	.937	23,8
PG 13.5	3171	3172	NLN PG 13.5	.250	6,4	1.062	27,0
PG 16	3173	3174	NLN PG 16	.250	6,4	1.171	29,7
PG 21	3175	3176	NLN PG 21	.281	7,1	1.406	35,7
PG 29	3177	3178	NLN PG 29	.281	7,1	1.812	46,0
PG 36	M9146	M9147	NLN PG 36	.281	7,1	2.244	56,9
PG 42	M9152	M9153	NLN PG 42	.320	8,1	2.750	69,9
PG 48	M9158	M9159	NLN PG 48	.375	9,5	2.835	72,0

Standard colors black or gray.

Metric Thread

THREAD TYPE AND SIZE	PART NO.		DESCRIPTION	PART DIMENSIONS			
	Black	Gray		A		B	
				Thickness	Wrenching Flats	in.	mm.
M12	M9130	M9131	NLN M12	.218	5,5	.750	19,1
M16	M9132	M9133	NLN M16	.218	5,5	.870	22,1
M20	M9134	M9135	NLN M20	.245	6,2	1.062	27,0
M25	M9136	M9137	NLN M25	.281	7,1	1.378	35,0
M32	M9138	M9139	NLN M32	.281	7,1	1.614	41,0
M40	M9140	M9141	NLN M40	.281	7,1	1.968	50,0
M50	M9148	M9149	NLN M50	.320	8,1	2.750	69,9
M63	M9154	M9155	NLN M63	.375	9,5	2.850	72,4

Standard colors black or gray.

Material	Nylon 6/6
Flammability Rating	94V-2 Standard—Consult Heyco for VO material
Temperature Range	-22°F (-30°C) to 221°F (105°C)

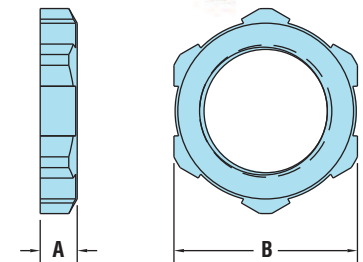
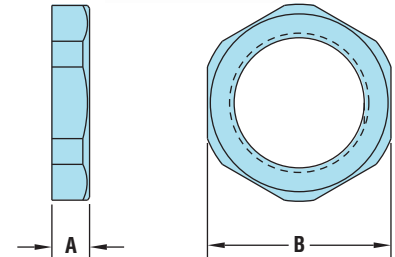
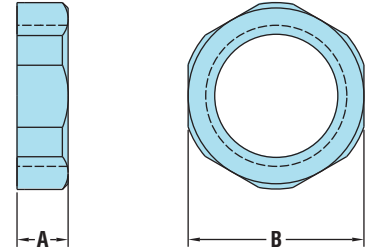

Quick Specs



Heyco-Flex™ Mounting Brackets

- For mounting Heyco-Flex Conduit or Tubing securely into place, vertically or horizontally. See pages 2-1, 2-7, and 2-8.
- Only fingertip pressure is required to snap conduit or tubing into bracket.
- Low profile design for space savings and pleasing appearance.
- Recommended distance between brackets at intervals not greater than 3 feet (1m) as required by Article 351-27 of 1996 NEC.
- Use one standard #10 (4-5M) screw for attaching bracket to panel (screw not included).
- Resist salt water, weak acids, gasoline, alcohol, oil, grease, and common solvents.

FITS CONDUIT/TUBING SIZE	PART NO.		DESCRIPTION	PART DIMENSIONS									
	Black	Gray		A		B		C		D		E	
				Inside Dia.	mm.	Length	mm.	Height	mm.	Outside Dia.	mm.	Width	mm.
3/8	1025	1026	HFB 3/8	.66	16,9	.91	23,2	.72	18,2	.90	22,9	.75	19,1
1/2	1027	1028	HFB 1/2	.79	20,0	1.07	27,3	.71	18,0	1.06	26,8		
3/4	1029	1030	HFB 3/4	1.05	26,7	1.27	32,2	.67	17,0	1.31	33,2		
1	1031	1032	HFB 1	1.24	31,5	1.52	38,6	.84	21,3	1.53	38,9		

Standard color black or gray.

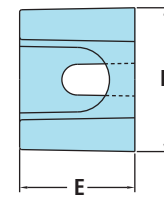
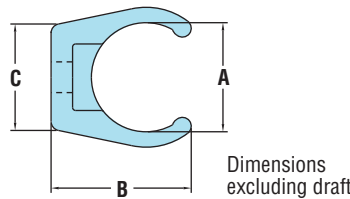

Heyco® Sealing Washers

- For use with Heyco-Flex fittings.
- Liquid tight, dust tight, and oil tight at enclosure.
- Suitable for wet locations requiring a separate gasket between the box and fitting.
- Also suitable for other panel sealing applications.
- Easy to install since washers seal off on the perimeter, not on the connector threads.
- Special double sealing ridges compensate for minor unevenness at enclosure.

Will Fit These Electrical Fitting NPT Trade Sizes	PART NO.	DESCRIPTION	PART DIMENSIONS					
			A		B		C	
			Inside Diameter	mm.	Outside Diameter	mm.	Thickness	mm.
1/4	3258	SW 1/4	.54	13,7	.80	20,2	.13	3,2
3/8	3259	SW 3/8	.67	17,0	1.01	25,5		
1/2	3260	SW 1/2	.85	21,6	1.24	31,5		
3/4	3261	SW 3/4	1.03	26,2	1.50	38,1	.14	3,4
1	3262	SW 1	1.28	32,5	1.77	45,0	.18	4,6
1-1/4	3264	SW 1-1/4	1.66	42,2	2.16	54,8	.16	4,1
1-1/2	3265	SW 1-1/2	1.86	47,2	2.44	62,0		
2	3257	SW 2	2.32	58,9	2.93	74,4	.18	4,6

Standard color black.

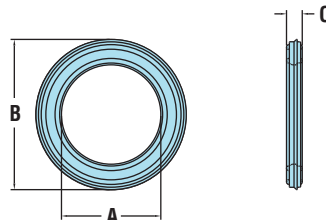

Quick Specs

Material	HFB - Nylon 6/6	SW - Thermoplastic Elastomer
Flammability Rating	HFB - 94V-2	SW - 94V-0
Temperature Range	-22°F (-30°C) to 221°F (105°C)	



Heyco® Foam Washers

Will Fit These Electrical Fitting NPT Trade Sizes	PART NO. Black	DESCRIPTION	PART DIMENSIONS					
			A Inside Dia.		B Outside Dia.		C Thickness	
			in.	mm.	in.	mm.	in.	mm.
.125" (3,2 mm) Thickness								
1/4	1970	HFW 500	.500	12,7	.820	20,8	.125	3,2
-	1971	HFW 625	.625	15,9	.940	23,9		
-	1972	HFW 750	.750	19,1	1.060	26,9		
1/2	1973	HFW 875	.875	22,2	1.185	30,1		
NEW!	1980	HFW 875 DD*	.875	22,2	1.185	30,1		
-	1974	HFW 1000	1.000	25,4	1.390	35,3		
3/4	1982	HFW 1125	1.125	28,6	1.515	38,5		
NEW!	1981	HFW 1125 DD*	1.125	28,6	1.515	38,5		
-	1983	HFW 1250	1.250	31,8	1.875	47,6		
1	1998	HFW 1375	1.375	34,9	2.000	50,8		
.190" (4,8 mm) Thickness								
1/4	1975	HFW 1/4	.480	12,2	.860	21,8	.190	4,6
1/2	1977	HFW 1/2	.840	21,3	1.200	30,5		
3/4	1978	HFW 3/4	1.050	26,7	1.500	38,1		
1	1979	HFW 1	1.300	33,0	1.700	43,2		

Standard color black.

*Feature flats across ID: PN 1980 - .750" (19,1 mm), PN 1981 - .965" (24,5 mm)

Heyco® Thermoplastic Rubber O-Rings

Will Fit These Electrical Fitting NPT Trade Sizes	PART NO. Black	DESCRIPTION	PART DIMENSIONS					
			A Inside Dia.		B Outside Dia.		C Thickness	
			in.	mm.	in.	mm.	in.	mm.
1/2	1995	ROR 1/2	.860	21,8	1.140	28,9	.140	3,5
3/4	1996	ROR 3/4	1.050	26,7	1.320	33,5		
1	1997	ROR 1	1.300	32,9	1.570	39,9		

Standard color black.

Consult Heyco for 1-1/4", 1-1/2" and 2" Electrical Trade and other sizes.



- For use with Heyco-Flex fittings mounted in non-threaded holes.
- Liquid tight, dust tight and oil tight at enclosure.
- Suitable for wet locations requiring a separate gasket between the fitting and enclosure.
- Resistant to petroleum oil, mineral oil and grease, diesel fuel, weak acids, alkali, and salt solutions.

Material	HFW EPDM	ROR Buna-N (Nitrile Rubber NBR)
Temperature Range	-4°F (-20°C) to 140°F (60°C)	-30°F (-34°C) to 212°F (100°C)

Quick
Specs

Heyco® Corrugated Conduit Systems

Chemical Resistance—Corrugated Nylon Nonmetallic Conduit and Fittings

Page 2-3

TYPE HPAS

Nylon PA6
corrugated,
standard weight

x	ACETONE
x	BENZENE
x	CARBON TETRACHLORIDE
x	CITRIC ACID
x	DIESEL OIL
x	DIETHYLAMINE
x	ETHANOL
x	ETHER
x	ETHYLAMINE
x	ETHYLENE GLYCOL
x	FREON 32
x	LUBRICATING OIL
x	MEK
x	PARAFFIN OIL
x	PETROL
x	SEA WATER
x	SILVER NITRATE
x	SKYDROL
x	SODIUM CHLORIDE
x	SODIUM HYDROXIDE (10%)
x	SODIUM HYDROXIDE (60%)
x	TOLUENE
x	TRANSFORMER OIL
x	1,1,1-TRICHLOROETHANE
x	TURPENTINE
x	VEGETABLE OIL
x	WATER

Design Characteristics

80N (18 lb)	for tubing ID less than 17 mm
156N (35 lb)	for tubing ID greater than 17 mm
-40 to 105°C	Temperature Range

x Provides limited resistance to this substance @ Data intended to indicate relative strength and will vary across different sizes. Figures shown for 21 mm nominal size.

IP RATINGS GUIDE

(Ingress Protection to BS EN 60529)

1st digit—protection against solid objects

- 0 No protection
- 1 Protected against objects greater than 50 mm
- 2 Protected against objects greater than 12 mm
- 3 Protected against objects greater than 2.5 mm
- 4 Protected against objects greater than 1.0 mm
- 5 Ingress of dust is not totally prevented but dust does not enter in harmful quantities
- 6 No ingress of dust

2nd digit—protection against water

- 0 No protection
- 1 Protected against falling drops
- 2 Protected against drops falling at 15 degrees
- 3 Low pressure spray—similar to shower head at up to 60 degrees from vertical
- 4 Low pressure spray—similar to shower head—from any angle
- 5 Medium pressure jet—similar to garden hose—from any angle
- 6 High pressure jet—similar to fire hose—from any angle
- 7 Submersion at 1 meter for 30 minutes
- 8 Higher water pressure e.g.: 5 bar for 5 hours. Conduits are tested in-house at up to 10 bar.
- 9K Steam clean, high pressure high temp jet wash to DIN40050.

HEYCO®
Liquid Tight
Cordgrips



3-1 Heyco-Tite Liquid Tight Cordgrips – Straight-thru, NPT



3-2 Heyco-Tite Liquid Tight Cordgrips – Split Gland, NPT, PG & Metric



3-3 Heyco-Tite Liquid Tight Cordgrips – Straight-thru, Pg



3-4 Heyco-Tite Liquid Tight Cordgrips – Straight-thru, Metric



3-5 thru 3-7 Heyco-Tite Liquid Tight Cordgrips – Pigtail, NPT, PG & Metric



3-8 thru 3-10 Heyco-Tite Liquid Tight Cordgrips – Right Angle Fold Over, NPT, PG & Metric



3-11 Heyco-Tite Liquid Tight Cordgrips – Straight-thru, Snap-in-2



3-12 Heyco-Tite Liquid Tight Cordgrips – Pigtail, Snap-in-2



3-13 & 3-14 Heyco-Tite Liquid Tight Cordgrips – Multi-hole



3-15 Heyco-Tite Liquid Tight Cordgrips – Break-thru Multi-hole



3-16 Heyco-Tite Liquid Tight Cordgrips – Romex® and Oval Holes



3-17 & 3-18 Heyco-Tite Liquid Tight Cordgrips – Halogen-free V-0, NPT, PG and Metric



3-19 Original Series-35 Liquid Tight Cordgrips – Straight-thru, NPT



3-20 Original Series-35 Liquid Tight Cordgrips – Straight-thru, Pg



3-21 Original Series-35 Liquid Tight Cordgrips – Pigtail, NPT



3-22 Original Series-35 Liquid Tight Cordgrips – Pigtail, Pg



3-23 HEYbrid Stainless Steel/Co-molded Liquid Tight Cordgrips – NPT



3-24 HEYbrid Stainless Steel Hazardous Location Liquid Tight Cordgrips – Pg



3-25 & 3-26 HEYbrid Stainless Steel/Co-molded Liquid Tight Cordgrips – PG & Metric



3-27 HEYbrid Plated Steel Liquid Tight Cordgrips – Straight-thru, NPT Hubs



3-28 Heyco-Tite Steel and Zinc Die-Cast Liquid Tight Cordgrips, NPT



3-29 thru 3-31 Heyco-Tite Aluminum Liquid Tight Cordgrips, Straight-thru, NPT



3-32 HEYbrid Aluminum Liquid Tight Cordgrips, Straight-thru, NPT



3-33 Heyco-Tite Aluminum Liquid Tight Cordgrips, Right Angle, NPT



3-34 thru 3-36 Heyco-Tite Brass Liquid Tight Cordgrips, NPT, PG and Metric



3-37 & 3-38 HEYbrid Brass/Nylon Liquid Tight Cordgrips, NPT, PG and Metric



3-39 & 3-40 Heyco-Tite Brass EMC Liquid Tight Cordgrips, PG and Metric



3-41 Heyco-Tite Brass EMC-2 Liquid Tight Cordgrips, Metric



3-41 Heyco-Tite EMC Brass Locknuts, PG and Metric



3-42 Heyco-Tite Lazy Bend Liquid Tight Cordgrips – EPDM & Stainless Steel Nozzle



3-43 Heyco-Tite Brass Profile Liquid Tight Cordgrips – Metric



3-44 Heyco-Tite Brass Liquid Tight Cordgrips - EXP & Brass Locking Plugs



3-45 Heyco-Tite Brass Liquid Tight Clamping Cordgrips – Metric



3-46 – 3-48 Retaining Sealing Washers and Nylon and Metal Locknuts – NPT (NPS), PG & Metric



3-49 Liquid Tight Hole Plugs



3-50 HEYCo-molded Liquid Tight Break-thru Plug



3-51 Liquid Tight Threaded Plugs, NPT, PG and Metric



3-52 Pg & Metric Threaded Plugs – Plastic & Ni-Plated Brass



3-53 HEYClean Liquid Tight Threaded and Snap-In Vent Plugs



3-54 HEYClean Brass Pressure Equalization and Drain Plugs, and Drain Plug Brass Locknuts

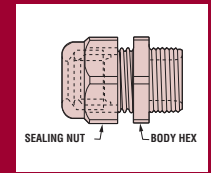

3-55 thru 3-59 LTCG Installation Instructions, DIN Specs, Torque Chart and Liquid Tight Cordgrip LabKit

“Stay Connected” with



Liquid Tight Cordgrips

a PennEngineering® Company

**NO O-RING
REQUIRED!**



Heyco®-Tite Liquid Tight Cordgrips

Straight-Thru, NPT Hubs with Integral Sealing Ring

The Ultimate in Liquid Tight Strain Relief Protection

- Integral Sealing Ring ensures a superior seal at the clearance or threaded mounting hole location, every time.
- Widest range of approved cable diameters.
- IP 68 rated.
- Approved for **NEMA 4, 4X, 6 and 6P** applications.
- Ratchet design of sealing nut assembly provides superior anti-vibration protection and ensures a firm grip on the cable.
- Acme threads on body prevent skipping and speed installation.
- All nylon construction with Buna N or TPE sealing gland resists salt water, weak acids, gasoline, alcohol, oil, grease, and common solvents. (This feature is not assessed by UL.)
- Multiple sizes for flexible cord diameters ranging from .065" (1,7 mm) to 1.730" (44,0 mm).
- We recommend using the fitting with the smallest maximum diameter that will fit your application.
- **Locknuts not included.** For nylon locknut specifications or to order locknuts separately, see page 3-47.
- For Heyco Liquid Tight Threaded Plugs, see page 3-51.
- Consult Heyco for cordgrips molded in other colors.

CABLE DIA. RANGE				PART NO.		DESCRIPTION	UL or RA	PART DIMENSIONS										
Minimum		Maximum		Black	Gray			A	B	C	D		E					
in.	mm.	in.	mm.			Clearance Hole Dia.	Max. O.A. Length	Thread Length	Wrenching Nut Thk.		Flat Size							
						in.	mm.	in.	mm.	in.	mm.	in.	mm.					
.065	1,7	.210	5,3	M4514	M4515	RLTCG 1/4	RA	.540	13,7	1.29	32,8	.45	11,4	.21	5,3	.63	16,0	
.115	2,9	.250	6,4	M4516	M4517	LTCG 1/4												
.065	1,7	.230	5,8	M3458	M3459	RLTCG 3/8	RA	.680	17,3	1.41	35,8	.49	12,4	.21	5,3	.82	20,8	
.105	2,7	.315	8,0	M3228	M3229	LTCG 3/8												
.095	2,4	.290	7,4	M4518	M4519	RLTCG 1/2	UL	.875	22,2	1.70	43,2	.61	15,5	.21	5,3	.98	24,9	
.170	4,3	.450	11,4	M3231	M3232	LTCG 1/2												
.180	4,6	.400	10,2	M4520	M4521	RLTCG LL 1/2	UL	.875	22,2	1.68	42,7	.44	11,2	.25	6,4	1.06	26,9	
.260	6,6	.545	13,8	M3200	M3201	LTCG LL 1/2												
.250	6,4	.490	12,4	M3460	M3461	RLTCG 3/4	UL	1.040	26,4	2.00	50,8	.62	15,7	.25	6,4	1.30	33,0	
.420	10,7	.630	16,0	M3234GA	M3235GA	LTCG 3/4												
.435	11,0	.705	17,9	M3234	M3235													
.490	12,4	.785	19,9	M8439	M8440	RLTCG 1	UL	1.326	33,7	2.41	61,2	.76	19,3	.30	7,6	1.73	43,9	
.590	15,0	1.000	25,4	M8437	M8438	LTCG 1												
.787	20,0	1.020	25,9	M4522	M4523	RLTCG 1-1/4	UL	1.680	42,7	2.69	68,3	.78	19,8	.30	7,6	2.05	52,1	
.865	22,0	1.260	32,0	M4524	M4525	LTCG 1-1/4												
1.000	25,4	1.240	31,5	M3319	M3320	RLTCG 1-1/2	UL	1.920	48,8	2.81	71,3	.77	19,6	.36	9,1	2.46	62,5	
1.230	31,2	1.560	39,6	M3317	M3318	LTCG 1-1/2												
1.160	29,5	1.350	34,3	M3323	M3324	RLTCG 2	UL	2.400	60,8	2.93	74,3	.79	20,1	.42	10,7	2.73	69,3	
1.450	36,8	1.730	43,9	M3321	M3322	LTCG 2												

Standard colors black and gray.

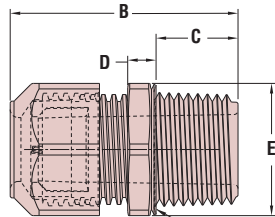
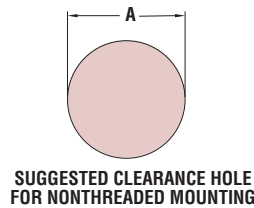

INTEGRAL SEALING RING

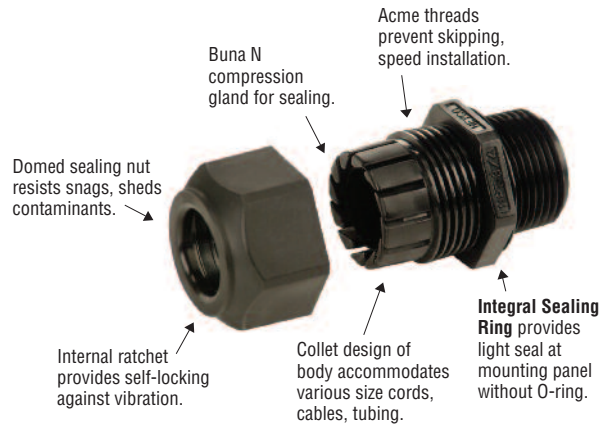

Material	Nylon 6/6 w/Buna N or TPE Sealing Gland
Certifications	<ul style="list-style-type: none"> UL Listed under Underwriters' Laboratories File E51579 RA Recognized under the Component Program of Underwriters' Laboratories File E51579 SF Certified By Canadian Standard Association File 93876C
Flammability Rating	94V-2—Consult factory for V0 material
Temperature Range	Static -40°F (-40°C) to 239°F (115°C) Dynamic -4°F (-20°C) to 212°F (100°C)
IP Rating	IP 68 (70 PSI, 5 BAR)

Quick Specs

“Stay Connected” with



Liquid Tight Cordgrips

a PennEngineering® Company

**NO O-RING
REQUIRED!**

Heyco® -Tite Liquid Tight Cordgrips

Split Gland for Pre-assembled Cables with Integral Sealing Ring

The Ultimate in Liquid Tight Strain Relief Protection



CABLE DIAMETER RANGE				PART NUMBER		DESCRIPTION	UL OR RU	PART DIMENSIONS											
Minimum	Maximum	Black	Gray	A	B			C	D		E	F	A	B	C	D	E	F	
in.	mm.	in.	mm.	Clearance Hole Dia.	Max. O.A. Length	Thread Length	Wrenching Nut Thickness	Flat Size	Sealing Nut Inside Dia.	in.	mm.	in.	mm.	in.	mm.	in.	mm.		
NPT Hubs																			
.210	5,3	.334	8,5	M3200GBH	M3201GBH	LTCG LL 1/2 NPT 8.5 MM Split	cRU _{us}	.875	22,2	1,68	42,7	.44	11,2	.25	6,4	1,06	27,0	.56	14,2
.210	5,3	.334	8,5	M3234GBH	M3235GBH	LTCG 3/4 NPT 8.5 MM Split	cRU _{us}	1.040	26,4	2,00	50,8	.62	15,7	.25	6,4	1,30	33,0	.72	18,3
.138	3,5	.610	15,5	M3234GBJ	M3235GBJ	LTCG 3/4 NPT Split Oval*	cRU _{us}	1.040	26,4	2,00	50,8	.62	15,7	.25	6,4	1,30	33,0	.72	18,3
.250	6,4	.334	8,5	M8437GBH	M8438GBH	LTCG 1 NPT 8.5 MM Split	cRU _{us}	1.326	33,7	2,41	61,2	.76	19,3	.30	7,6	1,73	43,9	1,01	25,7
				M4524GBH	M4525GBH	LTCG 1-1/4 NPT 8.5 MM Split	cRU _{us}	1.680	42,7	2,69	68,3	.78	19,8	.30	7,6	2,05	52,1	1,27	32,3
PG Hubs																			
.210	5,3	.334	8,5	M3219GBH	M3220GBH	LTCG 16 8.5MM Split	cRU _{us}	.886	22,5	1,68	42,7	.44	11,2	.25	6,4	1,06	27,0	.56	14,2
				M3222GBH	M3223GBH	LTCG 21 8.5MM Split	cRU _{us}	1.115	28,3	1,89	48,0	.52	13,2	.25	6,4	1,30	33,0	.72	18,3
.250	6,4	.334	8,5	M3225GBH	M3226GBH	LTCG 29 8.5MM Split	cRU _{us}	1.470	37,3	2,23	56,6	.57	14,5	.30	7,6	1,73	43,9	1,01	25,7
				M3204GBH	M3203GBH	LTCG 36 8.5MM Split	cRU _{us}	1.875	47,6	2,39	60,7	.47	11,9	.31	7,9	2,05	52,7	1,27	32,3
Metric Hubs																			
.210	5,3	.334	8,5	M3198GBH	M3199GBH	LTCG LL M20 8.5MM Split	cRU _{us}	.787	20,0	1,65	41,9	.41	10,4	.25	6,4	1,06	26,9	.56	14,2
				M4344GBH	M4345GBH	LTCG M25 8.5MM Split	cRU _{us}	.985	25,0	1,89	48,0	.52	13,2	.25	6,4	1,30	33,0	.72	18,3
.250	6,4	.334	8,5	M4348GBH	M4349GBH	LTCG M32 8.5MM Split	cRU _{us}	1.260	32,0	2,23	56,6	.58	14,7	.30	7,6	1,73	43,9	1,01	25,7
				M4352GBH	M4353GBH	LTCG M40 8.5MM Split	cRU _{us}	1.575	40,0	2,39	60,7	.47	11,9	.31	7,9	2,05	52,7	1,27	32,3

Standard color black.

*Oval shaped gland opening; not UL Recognized.

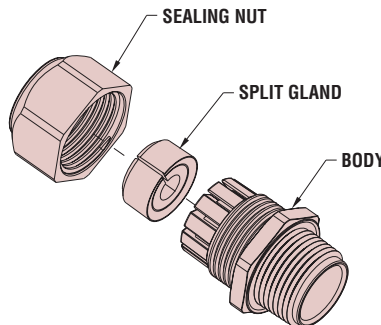
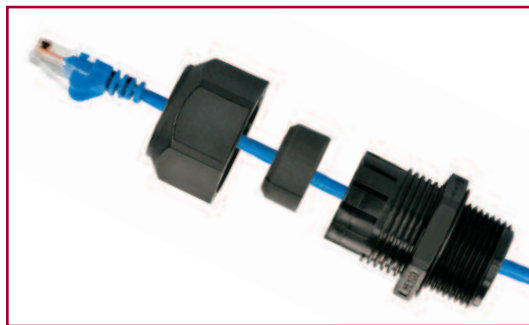
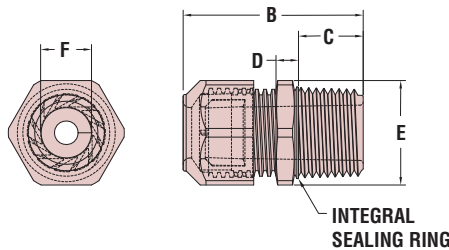

- Split Glands are designed for application to the cable **after the cable has passed through the LTCG**; e.g., RJ45 cable with Cat5e termination.
- Simply pass the cable termination through the LTCG body, apply Split Gland to the cable, and insert the gland/cable assembly into the LTCG fingers. Then tighten the Sealing Nut to achieve a **liquid tight seal**.
- For other cable/termination configuration sizes, and Pg and Metric hub threads, please consult Heyco.
- Integral Sealing Ring ensures a superior seal at the clearance or threaded mounting hole location, every time.

Material	Nylon 6/6 w/TPE Sealing Gland
Certifications	cRU _{us} Recognized under the Component Program of Underwriters' Laboratories File E51579 to both Canadian and U.S. Requirements
Flammability Rating	94V-2—Consult factory for V0 material
Temperature Range	Static -40°F (-40°C) to 239°F (115°C) Dynamic -4°F (-20°C) to 212°F (100°C)
IP Rating	IP 68 (70 PSI, 5 BAR)

*Quick
Specs*

“Stay Connected” with



Liquid Tight Cordgrips

a PennEngineering® Company

**NO O-RING
REQUIRED!**



Heyco®-Tite Liquid Tight Cordgrips

Straight-Thru, PG* Hubs with Integral Sealing Ring

The Ultimate in Liquid Tight Strain Relief Protection

- Integral Sealing Ring ensures a superior seal at the clearance or threaded mounting hole location, every time.
- Widest range of approved cable diameters.
- IP 68 rated.
- Approved for **NEMA 4, 4X, 6 and 6P** applications.
- Ratchet design of sealing nut assembly provides superior anti-vibration protection and ensures a firm grip on the cable.
- Acme threads on body prevent skipping and speed installation.
- All nylon construction with Buna N or TPE sealing gland resists salt water, weak acids, gasoline, alcohol, oil, grease, and common solvents. (This feature is not assessed by UL.)
- Multiple sizes for flexible cord diameters ranging from .065" (1,7 mm) to 1.730" (44,0 mm).
- We recommend using the fitting with the smallest maximum diameter that will fit your application.
- **Unassembled Nylon Locknuts INCLUDED.**
- For Heyco Liquid Tight Threaded Plugs, see page 3-51.
- Consult Heyco for cordgrips molded in other colors.

CABLE DIA. RANGE				PART NO.			DESCRIPTION	UL or CSA	PART DIMENSIONS							
Minimum		Maximum		Including Nylon Nut**		No Nut Black ††			A Clearance Hole Dia.	B Max. O.A. Length	C Thread Length		E Wrenching Nut Flats			
in.	mm.	in.	mm.	Black	Gray		in.	mm.	in.	mm.	in.	mm.	in.	mm.		
Standard Thread																
.065	1,7	.210	5,3	M3444	M3445	M4754	RLTCG 7		.492	12,5	1.16	29,5	.32	8,1	.63	16,0
.115	2,9	.250	6,4	M3207	M3208	M4752	LTCG 7	UL								
.065	1,7	.230	5,8	M3446	M3447	M4758	RLTCG 9		.599	15,2	1.25	31,8	.32	8,1	.82	20,8
.105	2,7	.315	8,0	M3210	M3211	M4756	LTCG 9	UL								
.069	1,8	.260	6,6	M3448	M3449	M4762	RLTCG 11		.733	18,6	1.48	37,6	.38	9,7	.94	23,9
.230	5,8	.400	10,2	M3213	M3214	M4760	LTCG 11	UL								
.095	2,4	.290	7,4	M4500	M4501	M4506	RLTCG 13.5		.804	20,4	1.53	38,9	.41	10,4	.98	24,9
.170	4,3	.450	11,4	M3216	M3217	M4764	LTCG 13.5	UL								
.180	4,6	.400	10,2	M4502	M4503	M4508	RLTCG 16		.886	22,5	1.68	42,7	.44	11,2	1.06	26,9
.260	6,6	.545	13,8	M3219	M3220	M4766	LTCG 16	UL								
.250	6,4	.490	12,4	M3454	M3455	M4748	RLTCG 21									
.420	10,7	.630	16,0	M3222GA	M3223GA	-	LTCG 21	UL	1.12	28,3	1.89	48,0	.52	13,2	1.30	33,0
.435	11,0	.705	17,9	M3222	M3223	M4768										
.490	12,4	.785	19,9	M4504	M4505	M4512	RLTCG 29		1.470	37,3	2.23	56,6	.57	14,5	1.73	43,9
.590	15,0	1.000	25,4	M3225	M3226	M4770	LTCG 29	UL								
.787	20,0	1.020	25,9	M3206	M3205	M4772	RLTCG 36		1.88	47,6	2.39	60,7	.47	11,9	2.05	52,7
.875	22,2	1.260	32,0	M3204	M3203	M4774	LTCG 36	UL								
1.000	25,4	1.240	31,5	M3218	M3215	M4740	RLTCG 42		2.130	54,1	2.50	63,5	.48	12,2	2.46	62,5
1.230	31,2	1.560	39,6	M3212	M3209	M4742	LTCG 42	UL								
1.160	29,5	1.350	34,3	M3283	M3284	M4744	RLTCG 48		2.340	59,4	2.63	66,7	.50	12,7	2.73	69,3
1.450	36,8	1.730	43,9	M3281	M3282	M4776	LTCG 48	UL								
Short Thread																
.069	1,8	.260	6,6	M3448ST	M3449ST	-	RLTCG 11 ST		.733	18,6	1.41	35,8	.31	7,9	.94	23,9
.230	5,8	.400	10,2	-	-	M3213ST	LTCG 11 ST	UL								
.250	6,4	.490	12,4	M3454ST	M3455ST	-	RLTCG 21 ST		1.115	28,3	1.80	45,7	.43	10,9	1.30	33,0
.435	11,0	.705	17,9	M3222ST	M3223ST	-	LTCG 21 ST	UL								

Standard colors black and gray.

*Steel conduit threads per DIN 40430, see page 3-57

**Nylon locknuts shipped unassembled

††For No Nut Part Nos. in gray color please visit our Cordgrip product section at heyco.com

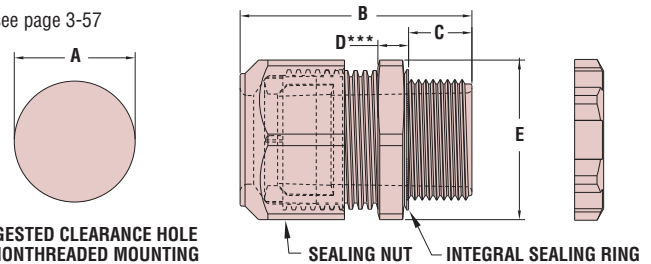

***Consult Heyco for Wrenching Nut Thickness "D"

Material	Nylon 6/6 w/Buna N or TPE Sealing Gland
Certifications	<ul style="list-style-type: none"> UL Listed under Underwriters' Laboratories File E51579 Recognized under the Component Program of Underwriters' Laboratories File E51579 CSA Certified by Canadian Standard Association File 93876C
Flammability Rating	94V-2
Temperature Range	Static -40°F (-40°C) to 239°F (115°C) Dynamic -4°F (-20°C) to 212°F (100°C)
IP Rating	IP 68 (70 PSI, 5 BAR)

Quick Specs

“Stay Connected” with



Liquid Tight Cordgrips

a PennEngineering® Company

**NO O-RING
REQUIRED!**

Heyco®-Tite Liquid Tight Cordgrips

Straight-Thru, Metric Hubs with Integral Sealing Ring

The Ultimate in Liquid Tight Strain Relief Protection



CABLE DIA. RANGE				PART NO.			DESCRIPTION	UL or IEC	PART DIMENSIONS							
Minimum		Maximum		Including Nylon Nut* Black Gray		No Nut Black ††			A Clearance Hole Dia.	B Max. O.A. Length		C Thread Length		E Wrenching Nut Flats		
in.	mm.	in.	mm.				in.	mm.	in.	mm.	in.	mm.	in.	mm.		
.065	1,7	.210	5,3	M4330	M4331	M4362	RLTCG M12	UL	.473	12,0	1.16	29,5	.32	8,1	.63	16,0
.115	2,9	.250	6,4	M4332	M4333	M4364	LTCG M12	UL								
.065	1,7	.230	5,8	M4334	M4335	M4366	RLTCG M16	UL	.630	16,0	1.25	31,8	.32	8,1	.82	20,8
.105	2,7	.315	8,0	M4336	M4337	M4368	LTCG M16	UL								
.095	2,4	.290	7,4	M4338	M4339	M4370	RLTCG M20	UL	.787	20,0	1.53	38,9	.41	10,4	.98	24,9
.170	4,3	.450	11,4	M4340	M4341	M4372	LTCG M20	UL								
.260	6,6	.545	13,8	M3198	M3199	-	LTCG LL M20	UL	.787	20,0	1.65	41,9	.41	10,4	1.06	26,9
.250	6,4	.490	12,4	M4342	M4343	M4374	RLTCG M25	UL	.985	25,0	1.89	48,0	.52	13,2	1.30	33,0
.435	11,0	.705	17,9	M4344	M4345	M4376	LTCG M25	UL								
.490	12,4	.785	19,9	M4346	M4347	M4378	RLTCG M32	UL	1.260	32,0	2.23	56,6	.57	14,5	1.73	43,9
.590	15,0	1.000	25,4	M4348	M4349	M4380	LTCG M32	UL								
.787	20,0	1.020	25,9	M4350	M4351	M4382	RLTCG M40	UL	1.575	40,0	2.39	60,7	.47	11,9	2.05	52,7
.865	22,0	1.260	32,0	M4352	M4353	M4384	LTCG M40	UL								
1.000	25,4	1.240	31,5	M3302	M3303	-	RLTCG M50	UL	1.970	50,0	2.50	63,5	.48	12,2	2.46	62,5
1.230	31,2	1.560	39,6	M3300	M3301	-	LTCG M50	UL								
1.160	29,5	1.350	34,3	M3306	M3307	-	RLTCG M63	UL	2.480	63,0	2.63	66,7	.50	12,7	2.73	69,3
1.450	36,8	1.730	43,9	M3304	M3305	-	LTCG M63	UL								

Standard colors black and gray.

*Nylon locknuts shipped unassembled

†† For No Nut Part Nos. in gray color please visit our Cordgrip product section at heyco.com

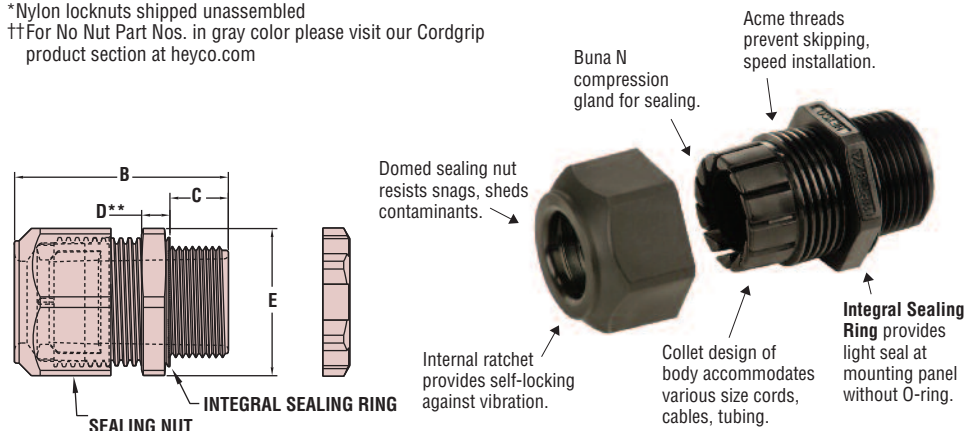

**Consult Heyco for Wrenching Nut Thickness “D”

- Integral Sealing Ring ensures a superior seal at the clearance or threaded mounting hole location, every time.
- Widest range of approved cable diameters.
- IP 68 rated.
- Approved for **NEMA 4, 4X, 6 and 6P** applications.
- Ratchet design of sealing nut assembly provides superior anti-vibration protection and ensures a firm grip on the cable.
- Acme threads on body prevent skipping and speed installation.
- All nylon construction with Buna N or TPE sealing gland resists salt water, weak acids, gasoline, alcohol, oil, grease, and common solvents. (This feature is not assessed by UL.)
- Multiple sizes for flexible cord diameters ranging from .065” (1,7 mm) to 1.730” (44,0 mm).
- We recommend using the cordgrip with the smallest maximum diameter that will fit your application.
- **Unassembled Nylon Locknuts INCLUDED.**
- For Heyco Liquid Tight Threaded Plugs, see page 3-51.
- Consult Heyco for cordgrips molded in other colors.

Material
Certifications

- UL Nylon 6/6 with Buna N or TPE Sealing Gland Listed under Underwriters’ Laboratories File E51579
- UL Recognized under the Component Program of Underwriters’ Laboratories File E51579
- CSA Certified by Canadian Standards Association File 93876C Approved for NEMA 4, 4X, 6 and 6P Applications
- UL Marks License #40010390
- CE Per EC Low Voltage Directive 73/23/EEC

Flammability Rating
Temperature Range

94V-2
Static -40°F (-40°C) to 239°F (115°C)
Dynamic -4°F (-20°C) to 212°F (100°C)

IP Rating

IP 68 (70 PSI, 5 BAR)

*Quick
Specs*

“Stay Connected” with



Liquid Tight Cordgrips

a PennEngineering® Company

**NO O-RING
REQUIRED!**



Heyco®-Tite Liquid Tight Cordgrips

Pigtail™, NPT Hubs with Integral Sealing Ring

The Ultimate in Liquid Tight Strain Relief Protection

- Flexible Pigtail extender prevents sharp bends and extends cable life.
- Integral Sealing Ring ensures a superior seal at the clearance or threaded mounting hole location, every time.
- Widest range of approved cable diameters.
- IP 68 rated.
- Approved for **NEMA 4, 4X, 6 and 6P** applications.
- Ratchet design of sealing nut assembly provides superior anti-vibration protection and ensures a firm grip on the cable.
- Acme threads on body prevent skipping and speed installation.
- All nylon construction with Buna N or TPE sealing gland resists salt water, weak acids, gasoline, alcohol, oil, grease, and common solvents. (This feature is not assessed by UL.)
- Multiple sizes for flexible cord diameters ranging from .065" (1,7 mm) to .705" (17,9 mm).
- We recommend using the fitting with the smallest maximum diameter that will fit your application.
- **Locknuts not included.** For nylon locknut specifications or to order locknuts separately, see page 3-47.
- For Heyco Liquid Tight Threaded Plugs, see page 3-51.
- Consult Heyco for cordgrips molded in other colors.

CABLE DIA. RANGE				PART NO.		DESCRIPTION	UL or RA	PART DIMENSIONS									
Minimum		Maximum		Locknuts Not Included* Black Gray				A Clearance Hole Dia.		B Max. O.A. Length		C Thread Length		D Wrenching Thk.		E Nut Flat Size	
in.	mm.	in.	mm.				in.	mm.	in.	mm.	in.	mm.	in.	mm.	in.	mm.	
.065	1,7	.210	5,3	M4536	M4537	Flex RLTCG 1/4	RA	.540	13,7	2.57	65,3	.45	11,4	.21	5,3	.63	16,0
.115	2,9	.250	6,4	M4538	M4539	Flex LTCCG 1/4											
.065	1,7	.230	5,8	M3474	M3475	Flex RLTCG 3/8	RA	.680	17,3	2.94	74,7	.49	12,4	.21	5,3	.82	20,8
.105	2,7	.315	8,0	M3254	M3255	Flex LTCCG 3/8											
.095	2,4	.290	7,4	M4540	M4541	Flex RLTCG 1/2	UL	.875	22,2	4.09	103,9	.61	15,5	.21	5,3	.98	24,9
.170	4,3	.450	11,4	M3251	M3252	Flex LTCCG 1/2											
.260	6,6	.546	13,9	M3266	M3267	Flex LTCCG LL 1/2	UL	.875	22,2	4.37	111,0	.44	11,2	.25	6,4	1.06	26,9
.250	6,4	.490	12,4	M3462	M3463	Flex RLTCG 3/4											
.435	11,0	.705	17,9	M3239	M3242	Flex LTCCG 3/4	UL	1.040	26,4	5.15	130,8	.62	15,7	.25	6,4	1.30	33,0

Standard colors black and gray.

*To order Nylon or Metal Locknuts separately, see pages 3-47 and 3-48.

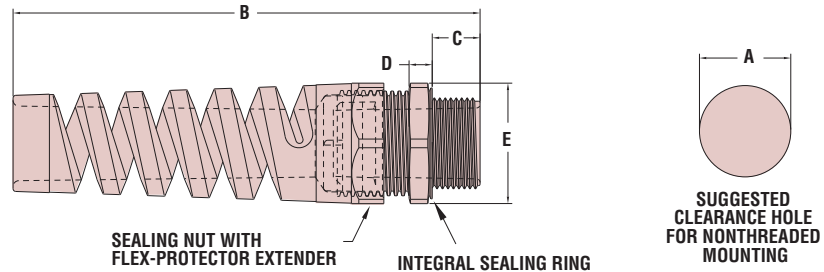
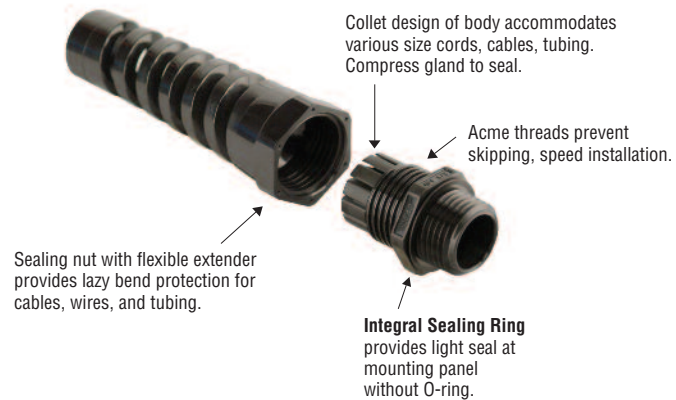

Material	Nylon 6/6 w/Buna N or TPE Sealing Gland
Certifications	<ul style="list-style-type: none"> UL Listed under Underwriters' Laboratories File E51579 RA Recognized under the Component Program of Underwriters' Laboratories File E51579 SF Certified by Canadian Standard Association File 93876C
Flammability Rating	94V-2
Temperature Range	Static -40°F (-40°C) to 239°F (115°C) Dynamic -4°F (-20°C) to 212°F (100°C)
IP Rating	IP 68 (70 PSI, 5 BAR)

*Quick
Specs*

“Stay Connected” with



Liquid Tight Cordgrips

a PennEngineering® Company

**NO O-RING
REQUIRED!**

Heyco® -Tite Liquid Tight Cordgrips

Pigtail™, PG* Hubs with Integral Sealing Ring

The Ultimate in Liquid Tight Strain Relief Protection



CABLE DIA. RANGE				PART NO.			DESCRIPTION	UL or RA	PART DIMENSIONS							
Minimum		Maximum		Including Nylon Nut**		No Nut Black††			A Clearance Hole Dia.	B Max. O.A. Length		C Thread Length		E Wrenching Nut Flats		
in.	mm.	in.	mm.	Black	Gray		in.	mm.	in.	mm.	in.	mm.	in.	mm.		
.065	1,7	.210	5,3	M3464	M3465	M4780	Flex RLTCG 7	RA	.492	12,5	2,44	62,0	.32	8,1	.63	16,0
.115	2,9	.250	6,4	M3237	M3238	M4778	Flex LTCG 7									
.065	1,7	.230	5,8	M3466	M3467	M4784	Flex RLTCG 9	RA	.599	15,2	2,77	70,4	.32	8,1	.82	20,8
.105	2,7	.315	8,0	M3240	M3241	M4782	Flex LTCG 9									
.069	1,8	.250	6,6	M3468	M3469	M4788	Flex RLTCG 11	RA	.733	18,6	3,46	87,9	.38	9,7	.94	23,9
.230	5,8	.400	10,2	M3243	M3244	M4786	Flex LTCG 11									
.095	2,4	.290	7,4	M4526	M4527	M4530	Flex RLTCG 13.5	UL	.804	20,4	3,89	98,8	.41	10,4	.98	24,9
.170	4,3	.450	11,4	M3246	M3247	M4790	Flex LTCG 13.5									
.180	4,6	.400	10,2	M4528	M4529	M4532	Flex RLTCG 16	UL	.886	22,5	4,37	111,0	.44	11,2	1,06	26,9
.260	6,6	.545	13,8	M3249	M3250	M4792	Flex LTCG 16									
.250	6,4	.490	12,4	M3478ST	M3479ST	-	Flex RLTCG 21 ST	UL	1.115	28,3	4.95	125,7	.43†	10,9	1.30	33,0
.435	11,1	.705	17,9	M3245ST	M3248ST	-	Flex LTCG 21 ST									
.250	6,4	.490	12,4	M3478	M3479	M4796	Flex RLTCG 21	UL	1.115	28,3	5.04	128,0	.52	13,2	1.30	33,0
.435	11,1	.705	17,9	M3245	M3248	M4794	Flex LTCG 21									

Standard colors black and gray.

*Steel conduit threads per DIN 40430, see page 3-57.

**Nylon locknuts shipped unassembled

†.43" (10,9 mm) Shorty LTCG Thread Length.

††For No Nut Part Nos. in gray color please visit our Cordgrip product section at heyco.com

- Flexible Pigtail extender prevents sharp bends and extends cable life.
- Integral Sealing Ring ensures a superior seal at the clearance or threaded mounting hole location, every time.
- Widest range of approved cable diameters.
- IP 68 rated.
- Approved for **NEMA 4, 4X, 6 and 6P** applications.
- Ratchet design of sealing nut assembly provides superior anti-vibration protection and ensures a firm grip on the cable.
- Acme threads on body prevent skipping and speed installation.
- All nylon construction with Buna N or TPE sealing gland resists salt water, weak acids, gasoline, alcohol, oil, grease, and common solvents. (This feature is not assessed by UL.)
- Multiple sizes for flexible cord diameters ranging from .065" (1,7 mm) to .705" (17,9 mm).
- We recommend using the fitting with the smallest maximum diameter that will fit your application.
- **Unassembled Nylon Locknuts INCLUDED.**
- For Heyco Liquid Tight Threaded Plugs, see page 3-51.
- Consult Heyco for cordgrips molded in other colors.

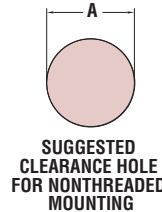
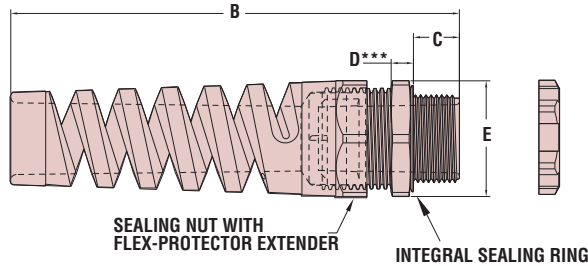

***Consult Heyco for Wrenching Nut Thickness "D"

Material	Nylon 6/6 w/Buna N or TPE Sealing Gland
Certifications	<ul style="list-style-type: none"> UL Listed under Underwriters' Laboratories File E51579 RA Recognized under Components Program of Underwriters' Laboratories File E51579 SF Certified by Canadian Standard Association File 93876C
Flammability Rating	94V-2
Temperature Range	Static -40°F (-40°C) to 239°F (115°C) Dynamic -4°F (-20°C) to 212°F (100°C)
IP Rating	IP 68 (70 PSI, 5 BAR)

Quick Specs

“Stay Connected” with



Liquid Tight Cordgrips

a PennEngineering® Company



**NO O-RING
REQUIRED!**

Heyco®-Tite Liquid Tight Cordgrips

Pigtail™, Metric Hubs with Integral Sealing Ring

The Ultimate in Liquid Tight Strain Relief Protection

- Flexible Pigtail extender prevents sharp bends and extends cable life.
- Integral Sealing Ring ensures a superior seal at the clearance or threaded mounting hole location, every time.
- Widest range of approved cable diameters.
- IP 68 rated.
- Approved for **NEMA 4, 4X, 6 and 6P** applications.
- Ratchet design of sealing nut assembly provides superior anti-vibration protection and ensures a firm grip on the cable.
- Acme threads on body prevent skipping and speed installation.
- All nylon construction with Buna N or TPE sealing gland resists salt water, weak acids, gasoline, alcohol, oil, grease, and common solvents. (This feature is not assessed by UL.)
- Multiple sizes for flexible cord diameters ranging from .065" (1,7 mm) to .705" (17,9 mm).
- We recommend using the fitting with the smallest maximum diameter that will fit your application.
- **Unassembled Nylon Locknuts INCLUDED.**
- For Heyco Liquid Tight Threaded Plugs, see page 3-51.
- Consult Heyco for cordgrips molded in other colors.

CABLE DIA. RANGE				PART NO.			DESCRIPTION	UL or IEC	PART DIMENSIONS							
Minimum		Maximum		Including Nylon Nut* Black Gray		No Nut Black ††			A Clearance Hole Dia.	B Max. O.A. Length		C Thread Length		E Wrenching Nut Flats		
in.	mm.	in.	mm.				in.	mm.	in.	mm.	in.	mm.	in.	mm.		
.065	1,7	.210	5,3	M4396	M4397	M4422	Flex RLTCG M12	UL	.473	12,0	2,44	62,0	.32	8,1	.63	16,0
.115	2,9	.250	6,4	M4398	M4399	M4424	Flex LTGC M12									
.065	1,7	.230	5,8	M4400	M4401	M4426	Flex RLTCG M16	UL	.630	16,0	2,77	70,4	.32	8,1	.82	20,8
.105	2,7	.315	8,0	M4402	M4403	M4428	Flex LTGC M16									
.095	2,4	.290	7,4	M4404	M4405	M4430	Flex RLTCG M20	UL	.787	20,0	3,89	98,8	.41	10,4	.98	24,9
.170	4,3	.450	11,4	M4406	M4407	M4432	Flex LTGC M20									
.260	6,6	.545	13,8	M3270	M3271	-	Flex LTGC LL M20	UL	.787	20,0	4,34	110,2	.41	10,4	1,06	26,9
.250	6,4	.490	12,4	M4408	M4409	M4434	Flex RLTCG M25									
.435	11,1	.705	17,9	M4410	M4411	M4436	Flex LTGC M25	UL	.985	25,0	5,04	128,0	.52	13,2	1,30	33,0

Standard colors black and gray.

*Nylon locknuts shipped unassembled

††For No Nut Part Nos. in gray color please visit our Cordgrip product section at heyco.com

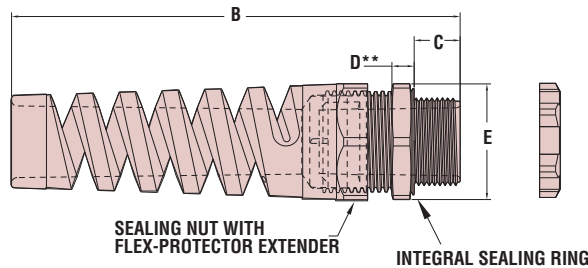
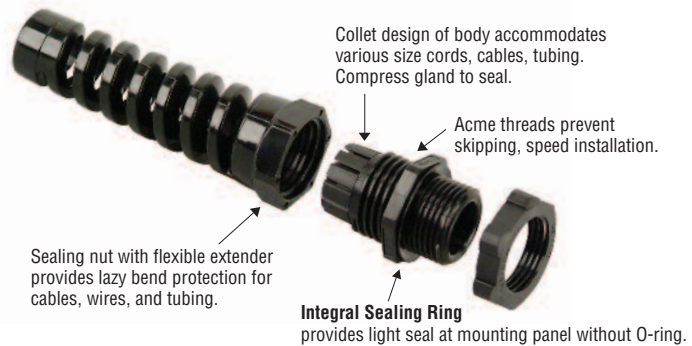

**Consult Heyco for Wrenching Nut Thickness "D"

*Quick
Specs*

Material	Nylon 6/6 w/Buna N or TPE Sealing Gland
Certifications	<ul style="list-style-type: none"> Listed under Underwriters' Laboratories File E51579 Recognized under Components Program of Underwriters' Laboratories File E51579 Certified by Canadian Standards Association File 93876C Approved for NEMA 4, 4X, 6 and 6P Applications VDE Marks License #40010390 Per CE Low Voltage Directive 73/23/EEC
Flammability Rating	94V-2
Temperature Range	Static -40°F (-40°C) to 239°F (115°C) Dynamic -4°F (-20°C) to 212°F (100°C)
IP Rating	IP 68 (70 PSI, 5 BAR)

“Stay Connected” with



Liquid Tight Cordgrips

a PennEngineering® Company

Heyco® -Tite Liquid Tight Cordgrips

Right Angle, NPT Hubs with Integral Sealing Ring

The Ultimate in Liquid Tight Strain Relief Protection

Patented Fold Over Design

**NO O-RING
REQUIRED!**



CABLE DIA. RANGE		PART NO.		DESCRIPTION	UL or IEC	PART DIMENSIONS											
in.	mm.	Black	Gray			A Clearance Hole Dia.	B Right Angle Height	C Max O.A. Length (Closed)	D Thread Length	E Sealing Nut Length	F Wrenching Nut Flat Size	in.	mm.	in.	mm.	in.	mm.
.065 - .210	1,7 - 5,3	M4560	M4561	RLTCG 1/4 90	UL	.540	13,7	.69	17,5	1,67	42,5	.45	11,4	.86	22,0	.63	16,0
.115 - .250	2,9 - 6,4	M4562	M4563	LTCG 1/4 90													
.065 - .230	1,7 - 5,8	M8560	M8561	RLTCG 3/8 90	UL	.680	17,3	.88	22,3	1,93	48,9	.49	12,4	1,07	27,1	.82	20,8
.105 - .315	2,7 - 8,0	M8562	M8563	LTCG 3/8 90													
.095 - .290	2,4 - 7,4	M4564	M4565	RLTCG 1/2 90	UL	.875	22,2	1,06	26,9	2,41	61,2	.61	15,5	1,38	35,1	.98	24,9
.170 - .450	4,3 - 11,4	M8564	M8565	LTCG 1/2 90													

Standard colors black and gray.

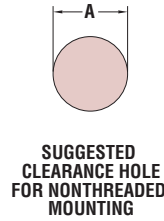
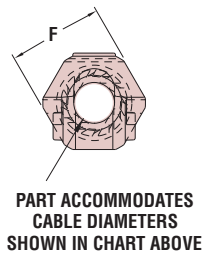
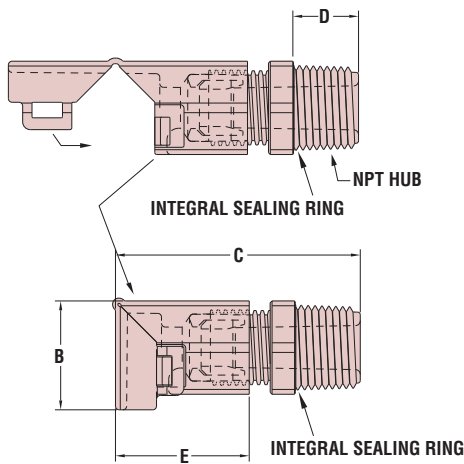

- Cordgrip is molded in the open position for ease of installation. After cable insertion, the fitting snaps closed, bending the cable without damage. This assembly method saves considerable time and money.
- Part design provides liquid tight integrity even in the open position.
- Integral Sealing Ring ensures a superior seal at the clearance or threaded mounting hole location, every time.
- Widest range of approved cable diameters.
- IP 68 rated.
- Approved for **NEMA 4, 4X, 6 and 6P** applications.
- Acme threads on body prevent skipping and speed installation.
- Multiple sizes for flexible cord diameters ranging from .065" (1,7 mm) to .450" (11,4 mm).
- We recommend using the fitting with the smallest maximum diameter that will fit your application.
- **Patented.**
- **Locknuts not included.** For nylon locknut specifications or to order locknuts separately, see page 3-47.
- For Heyco Liquid Tight Threaded Plugs, see page 3-51.
- Consult Heyco for cordgrips molded in other colors.



Material	Nylon 6/6 w/Buna N or TPE Sealing Gland
Certifications	<ul style="list-style-type: none"> UL Listed under Underwriters' Laboratories File E51579 Recognized under Components Program of Underwriters' Laboratories File E51579 SP Certified by Canadian Standard Association File 93876C
Flammability Rating	94V-2
Temperature Range	Static -40°F (-40°C) to 239°F (115°C) Dynamic -4°F (-20°C) to 212°F (100°C)
IP Rating	IP 68 (70 PSI, 5 BAR)

Quick
Specs



**NO O-RING
REQUIRED!**

Heyco® -Tite Liquid Tight Cordgrips

Right Angle, PG Hubs with Integral Sealing Ring

The Ultimate in Liquid Tight Strain Relief Protection

Patented Fold Over Design

- Cordgrip is molded in the open position for ease of installation. After cable insertion, the cordgrip snaps closed, bending the cable without damage. This assembly method saves considerable time and money.
- Part design provides liquid tight integrity even in the open position.
- Integral Sealing Ring ensures a superior seal at the clearance or threaded mounting hole location, every time.
- Widest range of approved cable dimensions.
- IP 68 rated.
- Approved for **NEMA 4, 4X, 6 and 6P** applications.
- Acme threads on body prevent skipping and speed installation.
- All nylon construction with Buna N or TPE sealing gland resists salt water, weak acids, gasoline, alcohol, oil, grease, and common solvents. (This feature is not assessed by UL.)
- We recommend using the fitting with the smallest maximum diameter that will fit your application.
- **Patented.**
- **Unassembled Nylon Locknuts INCLUDED.**
- For Heyco Liquid Tight Threaded Plugs, see page 3-51.
- Consult Heyco for cordgrips molded in other colors.

CABLE DIA. RANGE		PART NO.		DESCRIPTION	UL or RA	PART DIMENSIONS											
in.	mm.	Black	Gray			A Clearance Hole Dia.	B Right Angle Height	C Max O.A. Length (Closed)	D Thread Length	E Sealing Nut Length	F Wrenching Nut Flat Size	in.	mm.	in.	mm.	in.	mm.
.065 - .210	1,7 - 5,3	M8530	M8531	RLTCG 7 90	RA	.492	12,5	.69	17,5	1,53	38,8	.32	8,1	.86	21,8	.63	16,0
.115 - .250	2,9 - 6,4	M8532	M8533	LTCG 7 90													
.065 - .230	1,7 - 5,8	M8534	M8535	RLTCG 9 90	RA	.599	15,2	.88	22,3	1,77	44,9	.32	8,1	1,07	27,1	8,2	20,8
.105 - .315	2,7 - 8,0	M8536	M8537	LTCG 9 90													
.069 - .260	1,8 - 6,6	M8538	M8539	RLTCG 11 90	RA	.733	18,6	.99	25,1	2,01	51,0	.38	9,7	1,23	31,2	.94	23,9
.230 - .400	5,8 - 10,2	M8540	M8541	LTCG 11 90													
.095 - .290	2,4 - 7,4	M4542	M4543	RLTCG 13.5 90	UL	.804	20,4	1,06	26,9	2,21	56,1	.41	10,4	1,38	35,1	.98	24,9
.170 - .450	4,3 - 11,4	M8542	M8543	LTCG 13.5 90													

Standard colors black and gray.

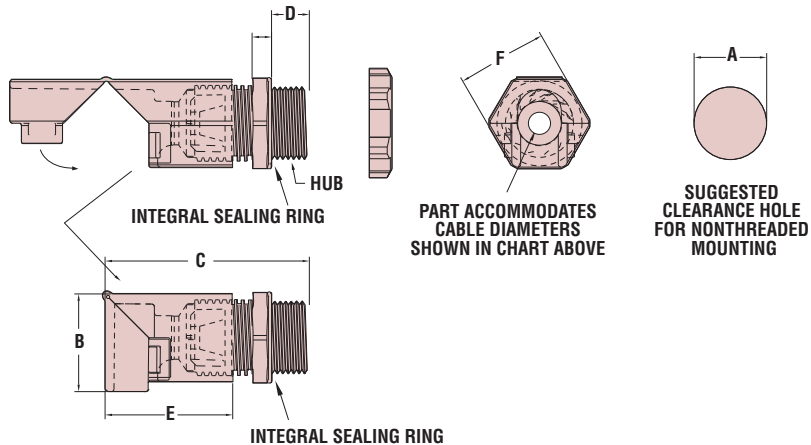

Material	Nylon 6/6 w/Buna N or TPE Sealing Gland
Certifications	<ul style="list-style-type: none"> UL Listed under Underwriters' Laboratories File E51579 RA Recognized under Components Program of Underwriters' Laboratories File E51579 CSA Certified by Canadian Standard Association File 93876C
Flammability Rating	94V-2
Temperature Range	Static -40°F (-40°C) to 239°F (115°C) Dynamic -4°F (-20°C) to 212°F (100°C)
IP Rating	IP 68 (70 PSI, 5 BAR)

Quick
Specs

“Stay Connected” with



Liquid Tight Cordgrips

a PennEngineering® Company

Heyco® -Tite Liquid Tight Cordgrips

Right Angle, Metric Hubs with Integral Sealing Ring

The Ultimate in Liquid Tight Strain Relief Protection

Patented Fold Over Design

**NO O-RING
REQUIRED!**



CABLE DIA. RANGE		PART NO.		DESCRIPTION	UL or RA	PART DIMENSIONS											
		Black	Gray			A	B	C		D		E		F			
in.	mm.					Clearance Hole Dia.	Right Angle Height	Max O.A. Length (Closed)	Thread Length	Sealing Nut Length	Wrenching Nut Flat Size						
						in.	mm.	in.	mm.	in.	mm.	in.	mm.	in.	mm.		
.065 - .210	1,7 - 5,3	M4448	M4449	RLTCG M12 90		.473	12,0	.69	17,5	1,53	38,8	.32	8,1	.86	22,0	.63	16,0
.115 - .250	2,9 - 6,4	M4450	M4451	LTCG M12 90	RA												
.065 - .230	1,7 - 5,8	M4452	M4453	RLTCG M16 90		.630	16,0	.88	22,3	1,77	44,9	.32	8,1	1,07	27,1	.82	20,8
.105 - .315	2,7 - 8,0	M4454	M4455	LTCG M16 90	RA												
.095 - .290	2,4 - 7,4	M4456	M4457	RLTCG M20 90		.787	20,0	1,06	26,9	2,21	56,1	.41	10,4	1,38	35,1	.98	24,9
.170 - .450	4,3 - 11,4	M4458	M4459	LTCG M20 90	UL												

Standard colors black and gray.

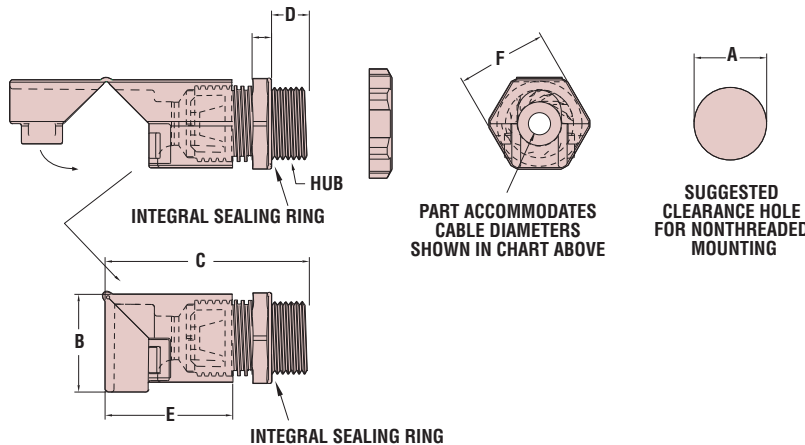

- Cordgrip is molded in the open position for ease of installation. After cable insertion, the cordgrip snaps closed, bending the cable without damage. This assembly method saves considerable time and money.
- Part design provides liquid tight integrity even in the open position.
- Integral Sealing Ring ensures a superior seal at the clearance or threaded mounting hole location, every time.
- Widest range of approved cable dimensions.
- IP 68 rated.
- Approved for **NEMA 4, 4X, 6 and 6P** applications.
- Acme threads on body prevent skipping and speed installation.
- All nylon construction with Buna N or TPE sealing gland resists salt water, weak acids, gasoline, alcohol, oil, grease, and common solvents. (This feature is not assessed by UL.)
- We recommend using the fitting with the smallest maximum diameter that will fit your application.
- **Patented.**
- CE Low Voltage Directive 73/23/EEC.
- VDE Marks License #40010390
- **Unassembled Nylon Locknuts INCLUDED.**
- For Heyco Liquid Tight Threaded Plugs, see page 3-51.
- Consult Heyco for cordgrips molded in other colors.

Material	Nylon 6/6 w/Buna N or TPE Sealing Gland
Certifications	<ul style="list-style-type: none"> Listed under Underwriters' Laboratories File E51579 Recognized under Components Program of Underwriters' Laboratories File E51579 Certified by Canadian Standard Association File 93876C Approved for NEMA 4, 4X, 6 and 6P Applications VDE Marks License #40010390 Low Voltage Directive 73/23/EEC
Flammability Rating	94V-2
Temperature Range	Static -40°F (-40°C) to 239°F (115°C) Dynamic -4°F (-20°C) to 212°F (100°C)
IP Rating	IP 68 (70 PSI, 5 BAR)

*Quick
Specs*

“Stay Connected” with



Liquid Tight Cordgrips

a PennEngineering® Company



Heyco® -Tite Snap-In-2® Liquid Tight Cordgrips

Straight-Thru, Snap-In Hubs

For Panels from .062" (1,6 mm) to .125" (3,2 mm) Thick

The Ultimate in Liquid Tight Strain Relief Protection

**NO LOCKNUT
REQUIRED!**

- Easy installation—unique fingers securely snap into a range of panel thicknesses – up to .125" (3,2 mm) – with no tools or locknuts required.
- Sealing flange prevents sealing washer displacement due to water velocity to ensure a liquid tight IP 65 seal.
- Eliminate need for locknut or threaded hole to achieve liquid tight seal at panel; perfect for low clearance installation where locking nut access is limited.
- Ratchet design of sealing nut assembly provides superior anti-vibration and ensures a firm grip on the cable.
- Foam washer included.
- Rotation prevented when used in Double D mounting holes.
- For Double D Mounting Hole Punches, see page 4-30.
- Available in multiple sizes for flexible cord diameters ranging from .065" (1,7 mm) to 1.000" (25,4 mm).
- We recommend using the fitting with the smallest maximum diameter that will fit your application.
- Consult Heyco for cordgrips molded in other colors.

CABLE DIA. RANGE				PART NO.	DESCRIPTION	UL or IEC	PANEL DIMENSIONS					
Minimum		Maximum					Black	A Mounting Hole Dia.		B To Prevent Rotation		C Max. O.A. Length
in.	mm.	in.	mm.			in.		mm.	in.	mm.	in.	mm.
.065	1,7	.210	5,3	M3802	LTRSCG 500	UL	.500	12,7	.450	11,4	1.21	30,7
.115	2,9	.250	6,4	M3800	LTSCG 500							
.065	1,7	.230	5,8	M3808	LTRSCG 625	UL	.625	15,9	.550	14,0	1.30	33,0
.105	2,7	.315	8,0	M3806	LTSCG 625							
.069	1,8	.250	6,4	M3814	LTRSCG 750	UL	.750	19,1	.660	16,8	1.48	37,6
.230	5,8	.395	10,0	M3812	LTSCG 750							
.095	2,4	.260	6,6	M3820	LTRSCG 875	UL	.875	22,2	.770	19,6	1.46	37,1
.170	4,3	.450	11,4	M3818	LTSCG 875							
.180	4,6	.440	11,2	M3826	LTRSCG 1000	UL	1.000	25,4	.875	22,2	1.62	41,1
.260	6,6	.546	13,9	M3824	LTSCG 1000							
.250	6,4	.485	12,3	M3838	LTRSCG 1125	UL	1.125	28,6	1.000	25,4	1.75	44,5
.485	12,3	.709	18,0	M3836	LTSCG 1125							
.490	12,4	.787	20,0	M3844	LTRSCG 1250	UL	1.250	31,8	1.125	28,6	2.05	52,1
.590	15,0	.920	23,4	M3842	LTSCG 1250							
.490	12,4	.787	20,0	M3850	LTRSCG 1375	UL	1.375	34,9	1.250	31,8	2.05	52,1
.590	15,0	1.000	25,4	M3848	LTSCG 1375							

Standard color black.

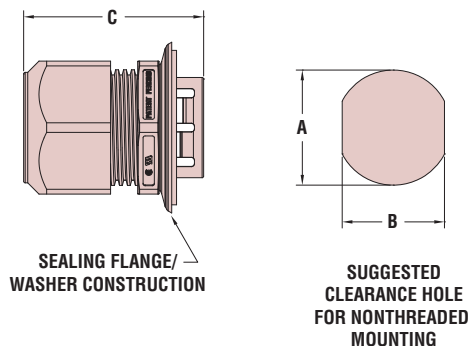

*Quick
Specs*

Material	Nylon 6/6 w/Buna N or TPE Sealing Gland
Certifications	UL Recognized under Components Program of Underwriters' Laboratories File E51579 CSA Certified by Canadian Standard Association File 93876C
Flammability Rating	94V-2
Temperature Range	Static -40°F (-40°C) to 239°F (115°C) Dynamic -4°F (-20°C) to 212°F (100°C)
IP Rating	IP 65

“Stay Connected” with



Liquid Tight Cordgrips

a PennEngineering® Company

Heyco® -Tite Snap-In-2® Liquid Tight Cordgrips

Pigtail™, Snap-In Hubs

For Panels from .062" (1,6 mm) to .125" (3,2 mm) Thick

The Ultimate in Liquid Tight Strain Relief Protection

**NO LOCKNUT
REQUIRED!**



CABLE DIA. RANGE				PART NO.	DESCRIPTION	UL or RU	PANEL DIMENSIONS					
Minimum		Maximum					Black	A Mounting Hole Dia.		B To Prevent Rotation		C Max. O.A. Length
in.	mm.	in.	mm.			in.		mm.	in.	mm.	in.	mm.
.065	1,7	.210	5,3	M3862	Flex LTRSCG 500	RU	.500	12,7	.450	11,4	2.50	63,5
.115	2,9	.250	6,4	M3860	Flex LTSCG 500							
.065	1,7	.230	5,8	M3868	Flex LTRSCG 625	RU	.625	15,9	.550	14,0	2.83	71,9
.105	2,7	.315	8,0	M3866	Flex LTSCG 625							
.069	1,8	.250	6,4	M3874	Flex LTRSCG 750	RU	.750	19,1	.660	16,8	3.46	87,9
.230	5,8	.395	10,0	M3872	Flex LTSCG 750							
.095	2,4	.260	6,6	M3880	Flex LTRSCG 875	RU	.875	22,2	.770	19,6	3.86	98,0
.170	4,3	.450	11,4	M3878	Flex LTSCG 875							
.180	4,6	.440	11,2	M3886	Flex LTRSCG 1000	RU	1.000	25,4	.875	22,2	4.32	109,7
.260	6,6	.546	13,9	M3884	Flex LTSCG 1000							
.485	12,3	.709	18,0	M3896	Flex LTSCG 1125	RU	1.125	28,6	1.000	25,4	4.90	124,5

Standard color black.

- Integral nylon spring eases the cable into a lazy bend; prevents kinking and assures longest cable and product life.
- Easy installation—unique fingers securely snap into a range of panel thicknesses – up to .125" (3,2 mm) – with no tools or locknuts required.
- Sealing flange prevents sealing washer displacement due to water velocity to ensure a liquid tight IP 65 seal.
- Eliminate need for locknut or threaded hole to achieve liquid tight seal at panel; perfect for low clearance installation where locking nut access is limited.
- Ratchet design of sealing nut assembly provides superior anti-vibration and ensures a firm grip on the cable.
- Foam washer included.
- Rotation prevented when used in Double D mounting holes.
- For Double D Mounting Hole Punches, see page 4-30.
- Available in multiple sizes for flexible cord diameters ranging from .065" (1,7 mm) to .709" (18,0 mm).
- We recommend using the fitting with the smallest maximum diameter that will fit your application.
- Consult Heyco for cordgrips molded in other colors.

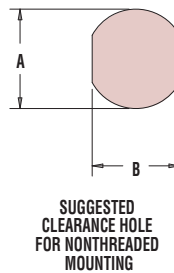
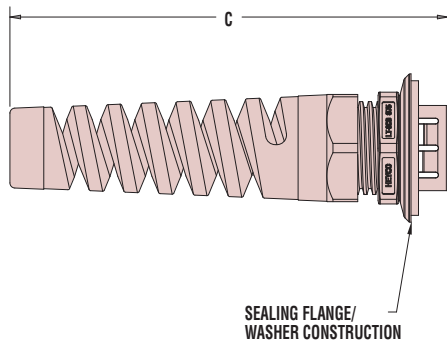

Material	Nylon 6/6 w/Buna N or TPE Sealing Gland
Certifications	<ul style="list-style-type: none"> RU Recognized under Components Program of Underwriters' Laboratories File E51579 CS Certified by Canadian Standard Association File 93876C
Flammability Rating	94V-2
Temperature Range	Static -40°F (-40°C) to 239°F (115°C) Dynamic -4°F (-20°C) to 212°F (100°C)
IP Rating	IP 65

Quick
Specs

“Stay Connected” with



Liquid Tight Cordgrips

a PennEngineering® Company



**NO O-RING
REQUIRED!**

Heyco® -Tite Liquid Tight Cordgrips

Multi-Hole with Integral Sealing Ring

Sequenced by Conductor Size

The Ultimate in Liquid Tight Strain Relief Protection

- Heyco® **Multi-hole glands** provide the widest range of conductor through-hole size and number configurations, many of which are agency approved. See the tabular charts for specific approvals for specific parts. These approvals are not “global” or implied approvals; they are both real and part specific.
- Integral Sealing Ring ensures a superior seal at the clearance or threaded mounting hole location, every time.
- IP 68 rated.
- Cordgrips are made of nylon construction with TPE sealing glands that resist salt water, weak acids, gasoline, alcohol, oil, grease, and common solvents.
- For body part dimensions see page 3-1, 3-3, and 3-4.
- Multi-hole glands are only to be used with Heyco Liquid Tight Cordgrips and are not sold separately.
- Consult Heyco for Cordgrips molded in other colors.

CONDUCTORS		NPT HUB*		PG HUB**		METRIC HUB**		
Hole Size mm.	No.	UL or IEC Part No.	Black Desc.	Black Part No.	Desc.	Black Part No.	Desc.	
Round, Open Holes – consult Heyco for Snap-in-2 Hub versions								
1,4	4		M3228GAP LTCG 3/8	M3210GAP	LTCG 9	M4336GAP	LTCG M16	
	6		M3228GAZ LTCG 3/8	M3210GAZ	LTCG 9	M4336GAZ	LTCG M16	
	10		M3228GE LTCG 3/8	M3210GE	LTCG 9	M4336GE	LTCG M16	
1,5	2		M4516GGBA LTCG 1/4	M3207GGBA	LTCG 7	M4332GGBA	LTCG M12	
	3		–	M3213GF	LTCG 11	–	–	
1,6	5		M3228GG LTCG 3/8	M3210GG	LTCG 9	M4336GG	LTCG M16	
1,7	2		M3228GH LTCG 3/8	M3210GH	LTCG 9	M4336GH	LTCG M16	
	3		M3228GJ LTCG 3/8	M3210GJ	LTCG 9	M4336GJ	LTCG M16	
	4		M3228GK LTCG 3/8	M3210GK	LTCG 9	M4336GK	LTCG M16	
2,0	3		M3231GL LTCG 1/2	M3216GL	LTCG 13	M4340GL	LTCG M20	
2,3	4		M3228GM LTCG 3/8	M3210GM	LTCG 9	M4336GM	LTCG M16	
2,5	2		M3231GN LTCG 1/2	M3216GN	LTCG 13	M4340GN	LTCG M20	
2,8	4		–	M3213GAY	LTCG 11	–	–	
3,0	2		M3228GP LTCG 3/8	M3210GP	LTCG 9	M4336GP	LTCG M16	
			–	M3213GB	LTCG 11***	–	–	
			–	M3213GP	LTCG 11	–	–	
	3		–	–	M3213GQ	LTCG 11	–	–
			M3231GQ	LTCG 1/2	M3216GQ	LTCG 13	M4340GQ	LTCG M20
			M3200GQ	LTCG LL 1/2	M3219GQ	LTCG 16	–	–
			M3200GR	LTCG LL 1/2	M3219GR	LTCG 16	–	–
6		M3231GS	LTCG 1/2	M3216GS	LTCG 13	M4340GS	LTCG M20	
		M3200GS	LTCG LL 1/2	M3219GS	LTCG 16	–	–	
3,8	2		M3231GT LTCG 1/2	M3216GT	LTCG 13	M4340GT	LTCG M20	
	6		M3200GW LTCG LL 1/2	M3219GW	LTCG 16	–	–	
4,0	2		–	M3213GAK	LTCG 11	–	–	
	3		M3231GX LTCG 1/2	M3216GX	LTCG 13	M4340GX	LTCG M20	
			M3200GX	LTCG LL 1/2	M3219GX	LTCG 16	–	–
	4		M3200GY LTCG LL 1/2	M3219GY	LTCG 16	–	–	
	5		M3200GZ LTCG LL 1/2	M3219GZ	LTCG 16	–	–	
6		M3200GGB LTCG LL 1/2	M3219GGB	LTCG 16	–	–		

Standard color black.

*Locknuts not included. For Locknut specifications or to order Locknuts separately, see pages 3-47 & 3-48.

**Unassembled Nylon Locknuts INCLUDED.

***Short Thread

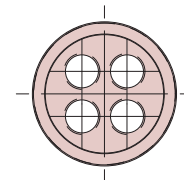

Multi-hole Gland (typical)

Quick Specs

Material	Nylon 6/6 with TPE Sealing Gland
Flammability Rating	94V-2 Standard
Temperature Range	Static -40°F (-40°C) to 239°F (115°C) Dynamic -4°F (-20°C) to 212°F (100°C)
IP Rating	IP 68

“Stay Connected” with



Liquid Tight Cordgrips

a PennEngineering® Company

Heyco® -Tite Liquid Tight Cordgrips

Multi-Hole with Integral Sealing Ring

Sequenced by Conductor Size

The Ultimate in Liquid Tight Strain Relief Protection

**NO O-RING
REQUIRED!**



CONDUCTORS		NPT HUB*		PG HUB**		METRIC HUB**				
Hole Size mm.	No.	UL or cULus	Black Part No.	Desc.	Black Part No.	Desc.	Black Part No.	Desc.		
Round, Open Holes – consult Heyco for Snap-in-2 Hub versions										
4,2	2		M3231GAB	LTCG 1/2	M3216GAB	LTCG 13	M4340GAB	LTCG M20		
4,5	9	cULus	M8437GBF	LTCG 1	M3225GBF	LTCG 29	M4348GBF	LTCG M32		
			M4524GBG	LTCG 1-1/4	M3204GBG	LTCG 36	M4352GBG	LTCG M40		
4,6	3		M3234GBD	LTCG 3/4	M3222GBD	LTCG 21	M4344GBD	LTCG M25		
			M3234GBE	LTCG 3/4	M3222GBE	LTCG 21	M4344GBE	LTCG M25		
5,0	2		M3231GAC	LTCG 1/2	M3216GAC	LTCG 13	M4340GAC	LTCG M20		
			M3234GAD	LTCG 3/4	M3222GAD	LTCG 21	M4344GAD	LTCG M25		
5,2	2	UL	M3231GAE†	LTCG 1/2	M3216GAE	LTCG 13	M4340GAE††	LTCG M20		
			3	UL	M3234GAF†	LTCG 3/4	M3222GAF	LTCG 21	M4344GAF	LTCG M25
					4	UL	M3234GAG†	LTCG 3/4	M3222GAG	LTCG 21
5,6	3	UL	M3200GAH†	LTCG LL 1/2	M3219GAH	LTCG 16	M3198GAH	LTCG LL M20		
6,0	2		M3200GAJ	LTCG LL 1/2	M3219GAJ	LTCG 16	M3198GAJ	LTCG LL M20		
			4	M3234GBC	LTCG 3/4	M3222GBC	LTCG 21	M4344GBC	LTCG M25	
6,5	6		M8437GAL	LTCG 1	M3225GAL	LTCG 29	M4348GAL	LTCG M32		
			M4524GAL	LTCG 1-1/4	M3204GAL	LTCG 36	M4352GAL	LTCG M40		
7,0	3		M3234GAM	LTCG 3/4	M3222GAM	LTCG 21	M4344GAM	LTCG M25		
7,4	2		M3234GAN	LTCG 3/4	M3222GAN	LTCG 21	M4344GAN	LTCG M25		
8,0	2		M3234GAQ	LTCG 3/4	M3222GAQ	LTCG 21	M4344GAQ	LTCG M25		
			6	M4524GAR	LTCG 1-1/4	M3204GAR	LTCG 36	M4352GAR	LTCG M40	
9,0	4		M8437GAS	LTCG 1	M3225GAS	LTCG 29	M4348GAS	LTCG M32		
			5	M4524GAT	LTCG 1-1/4	M3204GAT	LTCG 36	M4352GAT	LTCG M40	
			7	M4524GAW	LTCG 1-1/4	M3204GAW	LTCG 36	M4352GAW	LTCG M40	
9,5	4		M8437GAX	LTCG 1	M3225GAX	LTCG 29	M4348GAX	LTCG M32		

- Heyco® Multi-hole glands provide the widest range of conductor through-hole size and number configurations, many of which are agency approved. See the tabular charts for specific approvals for specific parts. These approvals are not “global” or implied approvals; they are both real and part specific.
- Integral Sealing Ring ensures a superior seal at the clearance or threaded mounting hole location, every time.
- IP 68 rated.
- Cordgrips are made of nylon construction with TPE sealing glands that resist salt water, weak acids, gasoline, alcohol, oil, grease, and common solvents.
- For body part dimensions see page 3-1, 3-3, and 3-4.
- Multi-hole glands are only to be used with Heyco Liquid Tight Cordgrips and are not sold separately.
- Consult Heyco for Cordgrips molded in other colors.

Standard color black.

*Locknuts not included. For Locknut specifications or to order Locknuts separately, see pages 3-47 & 3-48.

**Unassembled Nylon Locknuts INCLUDED.

†Assembled Metal Locknut INCLUDED

††M4340GAE is UL approved under File E51579



Material	Nylon 6/6 with TPE Sealing Gland
Certifications	UL Listed under Underwriters' Laboratories File E51579 cULus Recognized under the Component Program of Underwriters' Laboratories File E51579 to both Canadian and U.S. requirements
Flammability Rating	94V-2 Standard
Temperature Range	Static -40°F (-40°C) to 239°F (115°C) Dynamic -4°F (-20°C) to 212°F (100°C)
IP Rating	IP 68

Quick
Specs

“Stay Connected” with



Liquid Tight Cordgrips

a PennEngineering® Company

**NO O-RING
REQUIRED!**



- Heyco® **Break-Thru™ Skinned-Over glands** offer the flexibility to use fewer of the available holes while still providing a liquid tight seal around the conductors. Consult Heyco® for additional Skinned-over gland number, size, and hub configurations.
- Heyco® **Multi-hole glands** provide the widest range of conductor through-hole size and number configurations, many of which are agency approved. See the tabular charts for specific approvals for specific parts. These approvals are not “global” or implied approvals; they are both real and part specific.
- Integral Sealing Ring ensures a superior seal at the clearance or threaded mounting hole locaton, every time.
- Approved for **NEMA 4, 4X, 6 and 6P** applications.
- IP 68 rated.
- Cordgrips are made of nylon construction with TPE sealing glands that resist salt water, weak acids, gasoline, alcohol, oil, grease, and common solvents.
- For body part dimensions see page 3-1.
- Multi-hole glands are only to be used with Heyco Liquid Tight Cordgrips and are not sold separately.
- Consult Heyco for Cordgrips molded in other colors.

Heyco® -Tite Liquid Tight Break-Thru™ Cordgrips

Multi-Hole, NPT Hubs with Skinned-over Gland and Integral Sealing Ring

IP 68 Rated - Sequenced by Conductor Size

The Ultimate in Liquid Tight Strain Relief Protection

GLAND CONFIGURATION Conductors			PART NO.	DESCRIPTION	UL or CSA US	PART DIMENSIONS							
Type *	Size mm.	No.				Black	A Clearance Hole Dia. in. mm.	B Max. O.A. Length in. mm.	C Thread Length in. mm.	D Wrenching Nut Thickness in. mm.		E Flat Size in. mm.	

Break-Thru aka “Solar Mastheads”

USE-2	5,5	5	M3234GBR-SM	SMCG 3/4	UL	1.04	26.4	2.00	50.8	.62	15.7	.25	6.4	1.30	33.0
		9	M8437GBK-SM	SMCG 1	UL	1.33	33.8	2.41	61.2	.76	19.3	.30	7.6	1.73	43.9
		13	M4524GBM-SM	SMCG 1-1/4	UL	1.68	42.7	2.69	68.3	.78	19.8	.30	7.6	2.05	52.1
		21	M3317GBQ-SM	SMCG 1-1/2	UL	1.92	48.8	2.81	71.3	.76	19.3	.36	9.1	2.46	62.5
		31	M3321GBY-SM	SMCG 2	UL	2.40	60.8	2.93	74.3	.79	20.1	.42	10.7	2.73	69.3
USE-2	5,6	3	M3200GAH-SM	SMCG LL 1/2	UL	.87	22.2	1.68	42.7	.44	11.2	.25	6.4	1.06	26.9
PV 1000 or USE-2 **	7,7	3	M3234GBS-SM	SMCG 3/4	UL	1.04	26.4	2.00	50.8	.62	15.7	.25	6.4	1.30	33.0
		5	M8437GBT-SM	SMCG 1	UL	1.33	33.8	2.41	61.2	.76	19.3	.30	7.6	1.73	43.9
		9	M4524GBW-SM	SMCG 1-1/4	UL	1.68	42.7	2.69	68.3	.78	19.8	.30	7.6	2.05	52.1
		11	M3317GBZ-SM	SMCG 1-1/2	UL	1.92	48.8	2.81	71.3	.76	19.3	.36	9.1	2.46	62.5
PV 1000	8,9	19	M3321GBX-SM	SMCG 2	UL	2.40	60.8	2.93	74.3	.79	20.1	.42	10.7	2.73	69.3
		7	M4524GCJ-SM	SMCG 1-1/4	UL/CSA	1.68	42.7	2.69	68.3	.78	19.8	.30	7.6	2.05	52.1
		9	M3317GCK-SM	SMCG 1-1/2	UL	1.92	48.8	2.81	71.3	.76	19.3	.36	9.1	2.46	62.5
		12	M3321GCM-SM	SMCG 2	UL/CSA	2.40	60.8	2.93	74.3	.79	20.1	.42	10.7	2.73	69.3

Break-Thru Combo*** and custom parts

combo	0,8	2	M3231GCF-SM	SMCG 1/2	n/a	.87	22,2	1.70	43,2	.61	15,5	.21	5,3	.98	24,9
	6,0	1													
	0,8	5	M3231GCP-SM	SMCG 1/2	n/a	1.33	33,8	2.41	61,2	.76	19,3	.30	7,6	1.73	43,9
	6,0	1													
custom	3,3	6	M8437GCC-SM	SMCG 1	n/a	.87	22,2	1.68	42,7	.44	11,2	.25	6,4	1.06	26,9
	8,3	3													

Standard color black.

* AWG 10 and 12 for both USE-2 and PV 1000

** 8 AWG USE-2 Wire.

*** Combo parts for mixed conductor sizes and numbers. Consult Heyco for your particular Combo.

Metal Locknuts INCLUDED.

Don't see the Break-Thru configuration you need? Consult Heyco for your particular Conductor Size/Number and Hub configuration; or for additional Gland/Hub permutations not shown. Our Axcell Rapid Response Team is ready to meet your design requirements.

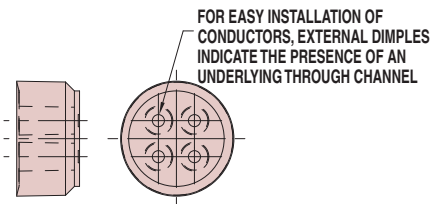

Break-Thru™ Skinned-over Gland (typical)

Material	Nylon 6/6 with TPE Sealing Gland
Certifications	<ul style="list-style-type: none"> UL Listed under Underwriters' Laboratories File E51579 CSA US Recognized under the Component Program of Underwriters' Laboratories File E51579 to both Canadian and U.S. requirements CSA Certified by the Canadian Standards Association File 93876
Flammability Rating	94V-2 Standard
Temperature Range	Static -40°F (-40°C) to 239°F (115°C) Dynamic -4°F (-20°C) to 212°F (100°C)
IP Rating	IP 68

“Stay Connected” with



Liquid Tight Cordgrips

a PennEngineering® Company

Heyco®-Tite Nylon Liquid Tight Romex® and Other Oval Hole Connectors

Straight-Thru, NPT Hubs with Integral Sealing Ring

For Romex® NM-B and UF-B Cables. For use in clearance or threaded holes, electrical conduit couplings and adapters.

The Ultimate in Liquid Tight Strain Relief Protection

**NO O-RING
REQUIRED!**



WILL FIT THESE CABLES				PART NO.	DESCRIPTION	UL	PART DIMENSIONS									
Romex® Type	AWG/ Conds.	Approximate Size					Black	A Clearance Hole Dia.	B Max. O.A. Length		C Thread Length		D Wrenching Nut Thickness		E Flat Size	
		in.	mm.		in.	mm.	in.	mm.	in.	mm.	in.	mm.	in.	mm.		

Romex® Connectors – assembled steel locknuts included

NM-B	14/2	.19 x .39	4,9 x 9,9	M3231GZA*	LTCG 1/2	UL	.875	22,2	1,70	43,2	.61	15,5	.21	5,3	.98	24,9
				M3234GZA	LTCG 3/4	-	1,040	26,4	2,00	50,8	.62	15,7	.25	6,4	1,30	33,0
NM-B	12/2	.21 x .42	5,3 x 10,7	M3231GZB*	LTCG 1/2	UL	.875	22,2	1,70	43,2	.61	15,5	.21	5,3	.98	24,9
				M3234GZB	LTCG 3/4	UL	1,040	26,4	2,00	50,8	.62	15,7	.25	6,4	1,30	33,0
UF-B	14/2	.18 x .35	4,5 x 8,9	M3234GZE	LTCG 3/4	-										
	12/2	.19 x .42	4,8 x 10,7	M3234GZF	LTCG 3/4	UL	1,040	26,4	2,00	50,8	.62	15,7	.25	6,4	1,30	33,0
		14/3	.19 x .63	4,8 x 16,1			M3234GZG*									

Other Oval Hole LTCGs – locknuts not included

n/a	n/a	.45 x .21	11,4 x 5,3	M3234GZK	LTCG 3/4	-	1,040	26,4	2,00	50,8	.62	15,7	.25	6,4	1,30	33,0
		.31 x .19	7,9 x 4,8	M3234GZM	LTCG 3/4	-										
		.69 x .19	17,5 x 4,8	M8437GZH	LTCG 1	-	1,326	33,7	2,41	61,2	.76	19,3	.30	7,6	1,73	43,9

Standard color black.

* Certified by Canadian Standard Association for NMD-90 wire-File 93876.

- Multiple gland sizes for 12/2 through 14/3 Romex® NM-B and UF-B cable. Consult Heyco for additional cable sizes.
- Hub sizes for 1/2 NPT and 3/4 NPT electrical knock-outs or threaded couplings. Consult Heyco for PG and Metric threaded hubs.
- Ratchet design of sealing nut assembly provides superior anti-vibration protection and ensures a firm grip on this cable.
- Integral Sealing Ring ensures a superior seal at mounting locations every time.
- All nylon construction with TPE sealing gland resists salt water, weak acids, gasoline, alcohol, oil, grease, and common solvents. (This feature is not assessed by UL.)
- **Assembled Metal Locknuts INCLUDED.**

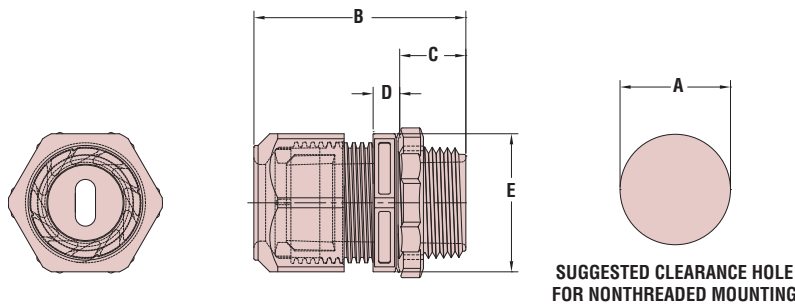

Material	Nylon 6/6 with TPE Sealing Gland
Certifications	UL Listed under Underwriters' Laboratories File E103540
Flammability Rating	94V-2
Temperature Range	Static -40°F (-40°C) to 239°F (115°C) Dynamic -4°F (-20°C) to 212°F (100°C)
IP Rating	IP 68

*Quick
Specs*

“Stay Connected” with



Liquid Tight Cordgrips

a PennEngineering® Company

**NO O-RING
REQUIRED!**

Heyco® -Tite Liquid Tight Cordgrips in Halogen Free V-0 Nylon

Straight-Thru, NPT Hubs with Integral Sealing Ring

The Ultimate in Liquid Tight Strain Relief Protection

- **Molded from a nylon material which, in the event of a fire, will not burn and will not produce toxic gases.** Also formulated for sunlight resistance.
- Integral Sealing ring ensures a superior seal at the clearance or threaded mounting hole location, every time.
- Widest range of approved cable diameters.
- IP 68 rated.
- Approved for **NEMA 4, 4X, 6 and 6P** applications.
- Ratchet design of sealing nut assembly provides superior anti-vibration protection and ensures a firm grip on the cable.
- Acme threads on body prevent skipping and speed installation.
- All nylon construction with Buna N sealing gland resists salt water, weak acids, gasoline, alcohol, oil, grease, and common solvents. (This feature is not assessed by UL).
- We recommend using the cordgrip with the smallest maximum diameter that will fit your application.
- Locknuts not included. For Nylon Locknut specifications, or to order nylon locknuts separately, see page 3-47.
- For Heyco Liquid Tight Threaded Plugs, see page 3-51.
- Consult Heyco for cordgrips molded in other colors.

CABLE DIA. RANGE				PART NO.	DESCRIPTION	UL or RA	PART DIMENSIONS									
Minimum		Maximum					Black	A Clearance Hole Dia.		B Max. O.A. Length		C Thread Length		D Wrenching Nut Thickness		E Flat Size
in.	mm.	in.	mm.		in.	mm.		in.	mm.	in.	mm.	in.	mm.	in.	mm.	
.065	1,7	.210	5,3	V4514	RLTCG 1/4	RA	.540	13,7	1.29	32,8	.45	11,4	.21	5,3	.63	16,0
.115	2,9	.250	6,4	V4516	LTCG 1/4											
.065	1,7	.230	5,8	V3458	RLTCG 3/8	RA	.680	17,3	1.41	35,8	.49	12,4	.21	5,3	.83	21,1
.105	2,7	.315	8,0	V3228	LTCG 3/8											
.095	2,4	.290	7,4	V4518	RLTCG 1/2	UL	.875	22,2	1.70	43,2	.61	15,5	.21	5,3	.98	24,9
.170	4,3	.450	11,4	V3231	LTCG 1/2											
.180	4,6	.400	10,1	V4520	RLTCG LL 1/2	UL	.875	22,2	1.68	42,7	.44	11,2	.25	6,4	1.07	27,0
.270	6,9	.545	13,8	V3200	LTCG LL 1/2											
.250	6,4	.490	12,4	V3460	RLTCG 3/4	UL	1.040	26,4	2.00	50,8	.62	15,7	.25	6,4	1.30	33,0
.435	11,0	.705	17,9	V3234	LTCG 3/4											
.490	12,4	.785	19,9	V8439	RLTCG 1	UL	1.326	33,7	2.41	61,2	.75	19,1	.30	7,6	1.73	43,9
.590	15,0	1.000	25,4	V8437	LTCG 1											
.787	20,0	1.020	25,9	V4522	RLTCG 1-1/4	UL	1.680	42,7	2.69	68,3	.77	19,6	.31	7,9	2.05	52,1
.940	23,9	1.260	32,0	V4524	LTCG 1-1/4											

Standard color black.

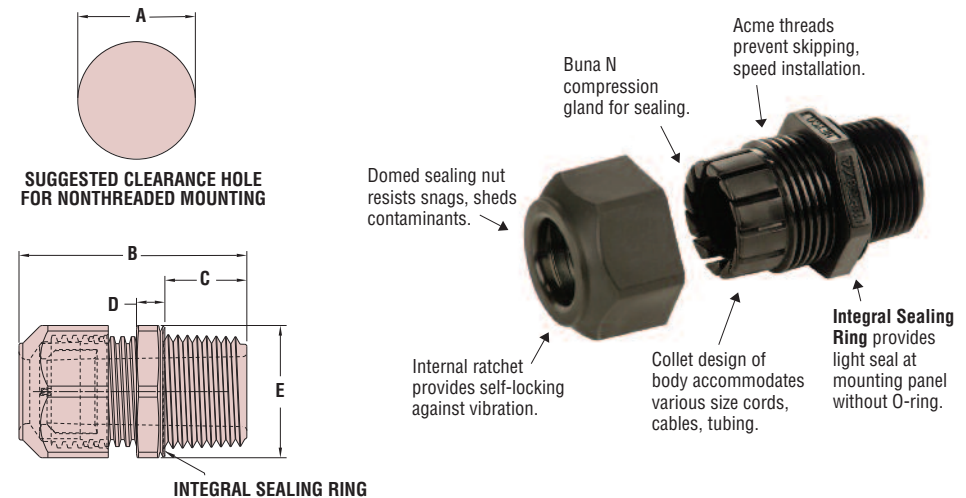

Quick
Specs

Material	Nylon 6/6 Non-halogenated w/Buna N Sealing Gland
Certifications	<ul style="list-style-type: none"> UL Listed under Underwriters' Laboratories File E51579 RA Recognized under the Component Program of Underwriters' Laboratories File E51579 SF Certified by Canadian Standard Association File 93876C
Flammability Rating	94V-0
Temperature Range	Static -40°F (-40°C) to 239°F (115°C) Dynamic -4°F (-20°C) to 212°F (100°C)
IP Rating	IP 68 (70 PSI, 5 BAR)

“Stay Connected” with



Liquid Tight Cordgrips

a PennEngineering® Company

Heyco® -Tite Liquid Tight Cordgrips in Halogen Free V-0 Nylon

Straight-Thru, PG & Metric Hubs with Integral Sealing Ring

The Ultimate in Liquid Tight Strain Relief Protection

**NO O-RING
REQUIRED!**



CABLE DIA. RANGE				PART NO.	DESCRIPTION	UL or RA	PART DIMENSIONS									
Minimum in.	Maximum in.	Minimum mm.	Maximum mm.				Black	A Clearance Hole Dia. in. mm.	B Max. O.A. Length in. mm.	C Thread Length in. mm.	D Wrenching Nut Thickness in. mm.		E Flat Size in. mm.			
PG Hubs																
.065	1,7	.210	5,3	V3444	RLTCG 7		.492	12,5	1.16	29,5	.32	8,1	.21	5,3	.63	16,0
.115	2,9	.250	6,4	V3207	LTCG 7	RA										
.065	1,7	.230	5,8	V3446	RLTCG 9		.599	15,2	1.25	31,8	.32	8,1	.21	5,3	.83	21,0
.105	2,7	.315	8,0	V3210	LTCG 9	RA										
.069	1,8	.260	6,6	V3448	RLTCG 11		.733	18,6	1.48	37,6	.38	9,7	.21	5,3	.94	23,9
.230	5,8	.400	10,2	V3213	LTCG 11	RA										
.095	2,4	.290	7,4	V4500	RLTCG 13.5		.804	20,4	1.53	38,9	.41	10,4	.21	5,3	.98	24,9
.170	4,3	.450	11,4	V3216	LTCG 13.5	UL										
.180	4,6	.400	10,2	V4502	RLTCG 16		.886	22,5	1.68	42,7	.44	11,2	.25	6,4	1.07	27,0
.270	6,9	.545	13,8	V3219	LTCG 16	UL										
.250	6,4	.490	12,4	V3454	RLTCG 21		1.115	28,3	1.89	48,0	.52	13,2	.25	6,4	1.30	33,0
.435	11,1	.705	17,9	V3222	LTCG 21	UL										
.490	12,4	.785	19,9	V4504	RLTCG 29		1.470	37,3	2.23	56,6	.58	14,7	.30	7,6	1.73	43,9
.590	15,0	1.000	25,4	V3225	LTCG 29	UL										
Metric Hubs																
.065	1,7	.230	5,8	V4334	RLTCG M16		.630	16,0	1.25	31,8	.32	8,1	.21	5,3	.83	21,1
.105	2,7	.315	8,0	V4336	LTCG M16	RA										
.095	2,4	.290	7,4	V4338	RLTCG M20		.787	20,0	1.49	37,8	.41	10,4	.21	5,3	.98	24,9
.170	4,3	.450	11,4	V4340	LTCG M20	UL										
.250	6,4	.490	12,4	V4342	RLTCG M25		.985	25,0	1.89	48,0	.51	13,0	.26	6,6	1.30	33,0
.435	11,1	.705	17,9	V4344	LTCG M25	UL										
.490	12,4	.785	19,9	V4346	RLTCG M32		1.260	32,0	2.23	56,6	.57	14,5	.30	7,6	1.73	43,9
.590	15,0	1.000	25,4	V4348	LTCG M32	UL										

Standard color black.

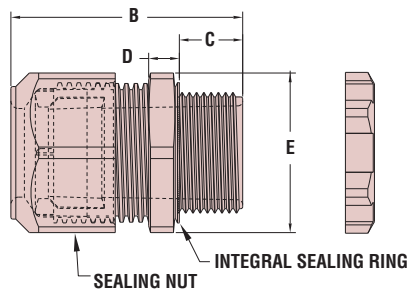

SUGGESTED CLEARANCE HOLE FOR NONTHEADED MOUNTING

- Molded from a nylon material which, in the event of a fire, will not burn and will not produce toxic gases. Also formulated for sunlight resistance.
- Integral Sealing ring ensures a superior seal at the clearance or threaded mounting hole location, every time.
- Widest range of approved cable diameters.
- IP 68 rated.
- Approved for NEMA 4, 4X, 6 and 6P applications.
- Ratchet design of sealing nut assembly provides superior anti-vibration protection and ensures a firm grip on the cable.
- Acme threads on body prevent skipping and speed installation.
- All nylon construction with Buna N sealing gland resists salt water, weak acids, gasoline, alcohol, oil, grease, and common solvents. (This feature is not assessed by UL).
- We recommend using the cordgrip with the smallest maximum diameter that will fit your application.
- **Unassembled Nylon Locknuts INCLUDED**
- For Nylon Locknut specifications, or to order nylon locknuts separately, see page 3-47.
- For Heyco Liquid Tight Threaded Plugs, see page 3-51.
- Consult Heyco for cordgrips molded in other colors.

Material
Certifications

- UL Nylon 6/6 Non-halogenated w/Buna N Sealing Gland Listed under Underwriters' Laboratories File E51579
- RA Recognized under the Component Program of Underwriters' Laboratories File E51579
- SP Certified by Canadian Standard Association File 93876C
- CEC Marks License #40010390 (Metric parts only)
- CE Per EC Low Voltage Directive 73/23/EEC (Metric parts only)

Flammability Rating
Temperature Range

94V-0
Static -40°F (-40°C) to 239°F (115°C)
Dynamic -4°F (-20°C) to 212°F (100°C)

IP Rating

IP 68 (70 PSI, 5 BAR)

Quick
Specs

“Stay Connected” with



Liquid Tight Cordgrips

a PennEngineering® Company



Heyco® Original Series-35 Liquid Tight Cordgrips Straight-Thru, NPT Hubs

- Wide range of approved cable diameters.
- IP 68 rated.
- Acme threads on body prevent skipping and speed installation.
- For use in clearance or threaded holes.
- All nylon construction with TPE sealing gland resists salt water, weak acids, gasoline, alcohol, oil, grease, and common solvents. (This feature is not assessed by UL.)
- Multiple sizes for flexible cord diameters ranging from .069” (1,8 mm) to 1.000” (25,4 mm). For larger sizes, see Heyco-Tite Liquid Tight Cordgrips on page 3-1.
- We recommend using the cordgrip with the smallest maximum diameter that will fit your application.
- **Locknuts not included.** For nylon locknut specifications or to order locknuts separately, see page 3-47.
- For Heyco Liquid Tight Threaded Plugs, see page 3-51.
- Consult Heyco for cordgrips molded in other colors.

CABLE DIA. RANGE				PART NO.		DESCRIPTION	UL or IEC	PART DIMENSIONS									
Minimum		Maximum		Locknuts Not Included*				A	B	C	D		E				
in.	mm.	in.	mm.	Black	Gray	Clearance Hole Dia.	Max. O.A. Length	Thread Length	Wrenching Nut Thk.		Flat Size						
						in.	mm.	in.	mm.	in.	mm.	in.	mm.				
.069	1,8	.187	4,7	3458	3459	RLTF 3/8		.670	17,0	1.49	37,8	.53	13,5	.20	5,1	.75	19,1
.115	2,9	.312	7,9	3228	3229	LTF 3/8	UL	.875	22,2	1.72	43,7	.62	15,7	.20	5,1	.95	24,1
.170	4,3	.450	11,4	3231	3232	LTF 1/2	UL	.875	22,2	1.83	46,5	.62	15,7	.23	5,8	1.05	26,7
.230	5,8	.546	13,9	3200	3201	LLTF 1/2	UL	.875	22,2	1.97	50,0	.63	16,0	.23	5,8	1.30	33,0
.250	6,4	.485	12,3	3204	3205	MRLTF 1/2	UL	.875	22,2	1.97	50,0	.63	16,0	.23	5,8	1.30	33,0
.450	11,4	.709	18,0	3202	3203	MLTF 1/2**	UL	.875	22,2	1.97	50,0	.63	16,0	.23	5,8	1.30	33,0
.250	6,4	.485	12,3	3460	3461	RLTF 3/4	UL	1.068	27,1	1.97	50,0	.63	16,0	.23	5,8	1.30	33,0
.450	11,4	.709	18,0	3234	3235	LTF 3/4	UL	1.068	27,1	1.97	50,0	.63	16,0	.23	5,8	1.30	33,0
.590	15,0	1.000	25,4	8437	8438	LTF 1	UL	1.350	34,3	2.42	61,5	.75	19,1	.28	7,1	1.65	41,9

NEW!
NEW!

Standard colors black and gray.

*To order Nylon or Metal Locknuts separately, see pages 3-47 and 3-48.

**For cable diameters greater than .600”, the insulating jacket must be stripped back. Reference customer drawing 3202/3203. For larger sizes, see Heyco-Tite Liquid Tight Cordgrips on page 3-1.

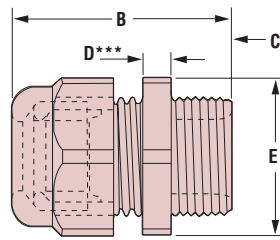
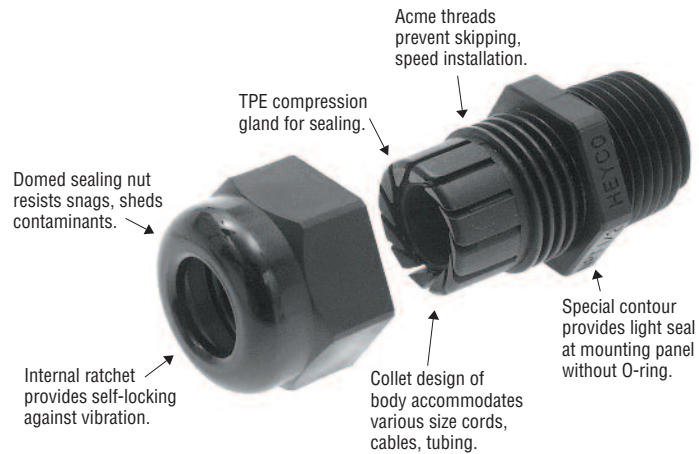

SEALING NUT

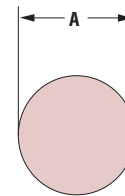

SUGGESTED CLEARANCE HOLE FOR NONTHREADED MOUNTING

Consult Heyco for your alternate material requirements!

Material	Nylon 6/6 with TPE Sealing Gland
Certifications	UL Listed under Underwriters' Laboratories File E51579 UL Recognized Under the Component Program of Underwriters' Laboratories File E51579 CS Certified by Canadian Standards Association File 93876C
Flammability Rating	94V-2
Temperature Range	Static -40°F (-40°C) to 239°F (115°C) Dynamic -4°F (-20°C) to 212°F (100°C)
IP Rating	IP 68 (70 PSI, 5 BAR)

Quick Specs

“Stay Connected” with



Liquid Tight Cordgrips

a PennEngineering® Company



Heyco® Original Series-35 Liquid Tight Cordgrips

Straight-Thru, PG* Hubs

CABLE DIA. RANGE				PART NO.			DESCRIPTION	UL or IEC	PART DIMENSIONS							
Minimum		Maximum		Including Nylon Nut**		No Nut Black ††			A Clearance Hole Dia.	B Max. O.A. Length		C Thread Length		E Wrenching Nut Flats		
in.	mm.	in.	mm.	Black	Gray		in.	mm.	in.	mm.	in.	mm.	in.	mm.		
.064	1,6	.210	5,3	3444	3445	4754	RLTF 7	UL	.492	12,5	1.17	29,7	.33	8,4	.59	15,0
.114	2,9	.250	6,4	3207	3208	4752	LTF 7									
.069	1,8	.187	4,7	3446	3447	4758	RLTF 9	UL	.599	15,2	1.30	33,0	.34	8,6	.75	19,1
.181	4,6	.312	7,9	3210	3211	4756	LTF 9									
.069	1,8	.260	6,6	3448	3449	4762	RLTF 11	UL	.733	18,6	1.46	37,1	.39	9,9	.86	21,8
.230	5,8	.395	10,0	3213	3214	4760	LTF 11									
.170	4,3	.450	11,4	3216	3217	4764	LTF 13.5	UL	.804	20,4	1.53	38,9	.41	10,4	.95	24,1
.230	5,8	.546	13,9	3219	3220	4766	LTF 16	UL	.886	22,5	1.66	42,2	.45	11,4	1.05	26,7
.250	6,4	.485	12,3	3454	3455	4748	RLTF 21	UL	1.115	28,3	1.87	47,5	.52	13,2	1.30	33,0
.450	11,4	.709	18,0	3222	3223	4768	LTF 21									
.590	15,0	.990	25,1	3225	3226	4770	LTF 29	UL	1.470	37,3	2.23	56,6	.59	15,0	1.66	42,2

Standard colors black and gray.

*Steel conduit threads per DIN 40430, see page 3-57

**Nylon locknuts shipped unassembled

††For No Nut Part Nos. in gray color please visit our Cordgrip product section at heyco.com

For larger sizes, see Heyco-Tite Liquid Tight Cordgrips on page 3-3.

- Wide range of approved cable diameters.
- IP 68 rated.
- Acme threads on body prevent skipping and speed installation.
- For use in clearance or threaded holes.
- All nylon construction with TPE sealing gland resists salt water, weak acids, gasoline, alcohol, oil, grease, and common solvents. (This feature is not assessed by UL.)
- PG hub threads are steel conduit threads per DIN 40430, see page 3-57.
- Multiple sizes for flexible cord diameters ranging from .064" (1,6 mm) to .990" (25,1 mm). For larger sizes, see Heyco-Tite Liquid Tight Cordgrips on page 3-3.
- We recommend using the fitting with the smallest maximum diameter that will fit your application.
- **Unassembled Nylon Locknuts INCLUDED.**
- For Heyco Liquid Tight Threaded Plugs, see page 3-51.
- Consult Heyco for cordgrips molded in other colors.

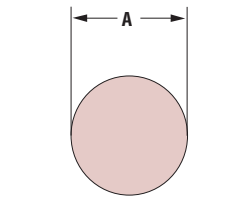
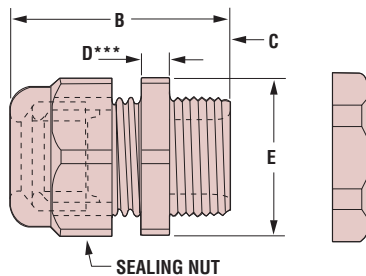

SUGGESTED CLEARANCE HOLE FOR NONTHREADED MOUNTING

***Consult Heyco for Wrenching Nut Thickness "D"

Material	Nylon 6/6 with TPE Sealing Gland
Certifications	<ul style="list-style-type: none"> UL Listed under Underwriters' Laboratories File E51579 UL Recognized under the Component Program of Underwriters' Laboratories File E51579 CS Certified by Canadian Standards Association File 93876C
Flammability Rating	94V-2
Temperature Range	Static -40°F (-40°C) to 239°F (115°C) Dynamic -4°F (-20°C) to 212°F (100°C)
IP Rating	IP 68 (70 PSI, 5 BAR)

Quick Specs

“Stay Connected” with



Liquid Tight Cordgrips

a PennEngineering® Company



Heyco® Original Series-35 Liquid Tight Cordgrips

Pigtail, NPT Hubs

- Flexible Pigtail™ extender prevents sharp bends and extends cable life.
- IP 68 rated.
- Widest range of approved cable diameters.
- For use in clearance or threaded holes.
- Acme threads on body prevent skipping and speed installation.
- All nylon construction with TPE sealing gland resists salt water, weak acids, gasoline, alcohol, oil, grease, and common solvents. (This feature is not assessed by UL.)
- Multiple sizes for flexible cord diameters ranging from .069" (1,8 mm) to .709" (18,0 mm).
- We recommend using the fitting with the smallest maximum diameter that will fit your application.
- **Locknuts not included.** For nylon locknut specifications or to order locknuts separately, see page 3-47.
- For Heyco Liquid Tight Threaded Plugs, see page 3-51.
- Consult Heyco for cordgrips molded in other colors.

CABLE DIA. RANGE				PART NO. Locknuts Not Included*		DESCRIPTION	UL or RA	PART DIMENSIONS									
Minimum		Maximum		Black	Gray			A Clearance Hole Dia.		B Max. O.A. Length		C Thread Length		D Wrenching Thk.		E Wrenching Nut Flat Size	
in.	mm.	in.	mm.					in.	mm.	in.	mm.	in.	mm.	in.	mm.		
.069	1,8	.187	4,7	3474	3475	FLEX RLTF 3/8	RA	.670	17,0	2.97	75,4	.53	13,5	.20	5,1	.75	19,1
.181	4,6	.312	7,9	3254	3255	FLEX LTF 3/8											
.170	4,3	.470	11,9	3251	3252	FLEX LTF 1/2	UL	.875	22,2	4.09	103,9	.62	15,7	.20	5,1	.95	24,1
.230	5,8	.546	13,9	3266	3267	FLEX LLTF 1/2	UL	.875	22,2	4.54	115,3	.62	15,7	.23	5,8	1.05	26,7
.250	6,4	.485	12,3	3462	3463	FLEX RLTF 3/4	UL	1.068	27,1	5.14	130,6	.63	16,0	.23	5,8	1.30	33,0
.450	11,4	.709	18,0	3239	3242	FLEX LTF 3/4											

Standard colors black and gray.

*To order Nylon or Metal Locknuts separately, see pages 3-47 and 3-48.

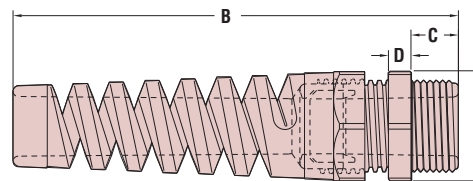
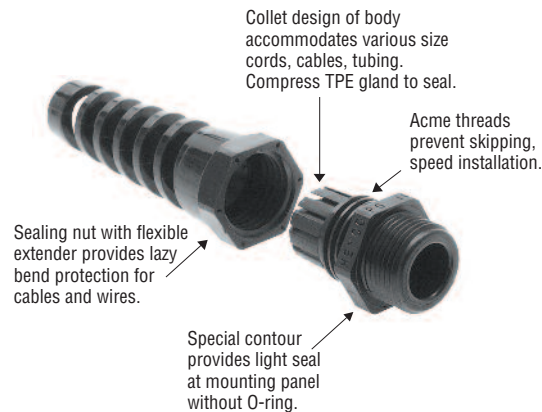

SEALING NUT WITH FLEX-PROTECTOR EXTENDER

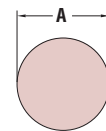

SUGGESTED CLEARANCE HOLE FOR NONTHREADED MOUNTING

Quick Specs

Material	Nylon 6/6 w/TPE Sealing Gland
Certifications	<ul style="list-style-type: none"> UL Listed under Underwriters' Laboratories File E51579 RA Recognized under the Component Program of Underwriters' Laboratories File E51579 CS Certified by Canadian Standards Association File 93876C
Flammability Rating	94V-2
Temperature Range	Static -40°F (-40°C) to 239°F (115°C) Dynamic -4°F (-20°C) to 212°F (100°C)
IP Rating	IP 68 (70 PSI, 5 BAR)

“Stay Connected” with



Liquid Tight Cordgrips

a PennEngineering® Company



Heyco® Original Series-35 Liquid Tight Cordgrips

Pigtail, PG* Hubs

CABLE DIA. RANGE				PART NO.			DESCRIPTION	UL or IEC	PART DIMENSIONS							
Minimum		Maximum		Including Nylon Nut**		No Nut Black ††			A Clearance Hole Dia.	B Max. O.A. Length	C Thread Length		E Wrenching Nut Flats			
in.	mm.	in.	mm.	Black	Gray		in.	mm.	in.	mm.	in.	mm.	in.	mm.		
.064	1,6	.210	5,3	3464	3465	4780	FLEX RLTF 7	UL	.492	12,5	2.44	62,0	.33	8,4	.59	15,0
.114	2,9	.250	6,4	3237	3238	4778	FLEX LTF 7									
.069	1,8	.187	4,7	3466	3467	4784	FLEX RLTF 9	UL	.599	15,2	2.77	70,4	.34	8,6	.75	19,1
.181	4,6	.312	7,9	3240	3241	4782	FLEX LTF 9									
.069	1,8	.260	6,6	3468	3469	4788	FLEX RLTF 11	UL	.733	18,6	3.44	87,4	.39	9,9	.86	21,8
.230	5,8	.395	10,0	3243	3244	4786	FLEX LTF 11									
.170	4,3	.450	11,4	3246	3247	4790	FLEX LTF 13.5	UL	.804	20,4	3.88	98,6	.41	10,4	.95	24,1
.230	5,8	.546	13,9	3249	3250	4792	FLEX LTF 16	UL	.886	22,5	4.36	110,7	.45	11,4	1.05	26,7
.250	6,4	.485	12,3	3478	3479	4796	FLEX RLTF 21	UL	1.115	28,3	5.03	127,8	.52	13,2	1.30	33,0
.450	11,4	.709	18,0	3245	3248	4794	FLEX LTF 21									

Standard colors black and gray.

*Steel conduit threads per DIN 40430, see page 3-57.

**Nylon locknuts shipped unassembled.

††For No Nut Part Nos. in gray color please visit our Cordgrip product section at heyco.com.

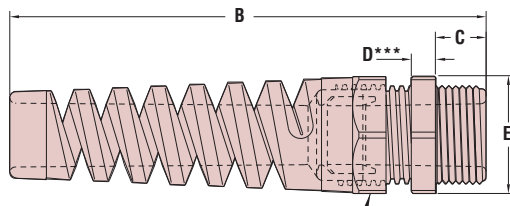
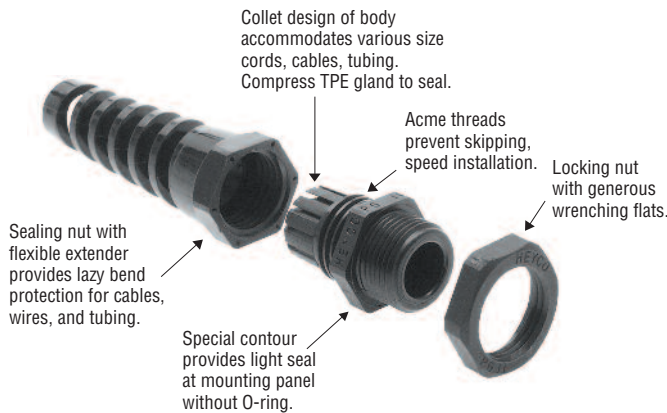

SEALING NUT WITH FLEX-PROTECTOR EXTENDER

SUGGESTED CLEARANCE HOLE FOR NONTHEADED MOUNTING

***Consult Heyco for Wrenching Nut Thickness “D”

- Flexible Pigtail™ extender prevents sharp bends and extends cable life.
- IP 68 rated.
- Widest range of approved cable diameters.
- For use in clearance or threaded holes.
- Acme threads on body prevent skipping and speed installation.
- PG hub threads are steel conduit threads per DIN 40430, see page 3-49.
- All nylon construction with TPE sealing gland resists salt water, weak acids, gasoline, alcohol, oil, grease, and common solvents. (This feature is not assessed by UL.)
- Multiple sizes for flexible cord diameters ranging from .064” (1,6 mm) to .709” (18,0 mm).
- We recommend using the fitting with the smallest maximum diameter that will fit your application.
- **Unassembled Nylon Locknuts INCLUDED.**
- For Heyco Liquid Tight Threaded Plugs, see page 3-51.
- Consult Heyco for cordgrips molded in other colors.

Material	Nylon 6/6 w/TPE Sealing Gland
Certifications	<ul style="list-style-type: none"> UL Listed under Underwriters’ Laboratories File E51579 Recognized under the Component Program of Underwriters’ Laboratories File E51579 CS Certified by Canadian Standards Association File 93876C
Flammability Rating	94V-2
Temperature Range	Static -40°F (-40°C) to 239°F (115°C) Dynamic -4°F (-20°C) to 212°F (100°C)
IP Rating	IP 68 (70 PSI, 5 BAR)

Quick Specs

“Stay Connected” with



Liquid Tight Cordgrips

a PennEngineering® Company



HEYbrid™ Stainless Steel Liquid Tight Cordgrips

Straight-Thru, NPT Hubs

Don't get SKU'ed: More Cable Range, Fewer SKU's – Genetically engineered to destroy your inventory monster!

The Ultimate in Liquid Tight Strain Relief Protection

- **HEYCo-molded gripping finger/gland technology** accommodates the **widest cable range** over the **fewest sku's**.
- Rolled grease-free threads **prevent galling** and allow for multiple assemblies and disassemblies. No messy, unsightly thread lubrication required.
- Self-retaining sealing rings eliminate the need for an O-Ring groove, thus **reducing cost**.
- Sealing washer required for through hole applications only.
- Typical applications: Control cabinets, marine, car washes, hot tubs, instrumentation, carpet cleaning machines, food processing equipment, underground for direct burial or submersed up to 130 ft. (70 PSIG).
- Ideal for corrosive environments.
- Constructed from corrosion resistant 303 stainless steel.
- Resistant to salt water, acids and most chemicals.
- Locknuts not included. To order locknuts separately, see page 3-48.
- Patent pending.
- DFARS Compliant

CABLE DIA. RANGE				PART NO.	DESCRIPTION	UL or RA	PART DIMENSIONS									
Minimum		Maximum					A	B	C	D		E				
in.	mm.	in.	mm.				Clearance Hole Dia.	Max. O.A. Length	Thread Length	Thickness	Wrenching Nut Flat Size	in.	mm.	in.	mm.	
HEYCo-molded Finger/Gland																
.065	1,7	.210	5,3	M6000	RSSCG 1/4	cULus	.540	13,7	1,29	32,8	.40	10,2	.20	5,1	.75	19,1
.115	2,9	.250	6,4	M6001	SSCG 1/4	cULus										
.065	1,7	.230	5,8	M6002	RSSCG 3/8	cULus	.680	17,3	1,39	35,3	.41	10,4	.20	5,1	.88	22,4
.105	2,7	.315	8,0	M6003	SSCG 3/8	cULus										
.095	2,4	.290	7,4	M6006	RSSCG 1/2	cULus	.875	22,2	1,69	42,9	.53	13,5	.20	5,1	1,06	26,9
.170	4,3	.450	11,4	M6007	SSCG 1/2	cULus										
.180	4,6	.400	10,1	M6008	RSSCG LL 1/2	cULus	.875	22,2	1,81	46,0	.53	13,5	.20	5,1	1,25	31,8
.260	6,6	.545	13,8	M6009	SSCG LL 1/2	cULus										
.250	6,4	.490	12,4	M6010	RSSCG 3/4	cULus	1,109	28,2	1,93	49,0	.55	14,0	.20	5,1	1,31	33,3
.435	11,0	.705	17,9	M6011	SSCG 3/4	cULus										
.490	12,4	.785	19,9	M6012	RSSCG 1	cULus	1,375	34,9	2,29	58,1	.69	17,5	.20	5,1	1,75	44,5
.590	15,0	1,000	25,4	M6013	SSCG 1	cULus										
Discrete Finger & Gland																
ALL NEW PRODUCTS																
.787	20,0	1,020	26,0	M6015	RSSCG 1-1/4	cULus	1,734	44,0	2,31	65,0	.71	18,0	.25	6,4	2,25	57,2
.865	22,0	1,260	32,0	M6016	SSCG 1-1/4	cULus										
1,000	25,4	1,240	31,5	M6017	RSSCG 1-1/2	cULus	1,984	50,4	2,69	67,1	.73	18,5	.25	6,4	2,50	63,5
1,230	31,2	1,560	39,6	M6018	SSCG 1-1/2	cULus										
1,160	29,5	1,350	34,3	M6019	RSSCG 2	cULus	2,469	62,7	2,92	74,2	.76	19,3	.25	6,4	2,75	69,9
1,450	36,8	1,730	44,0	M6020	SSCG 2	cULus										

The HEYCo-molded Finger, Gland & Seat

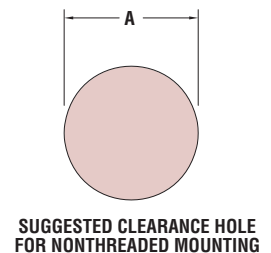
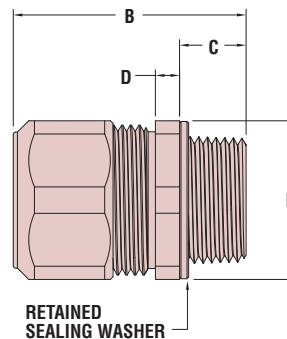
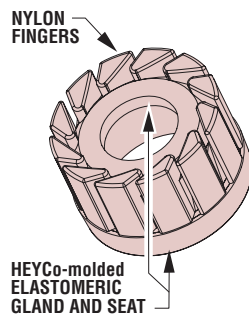

Quick Specs

Material	303 Stainless Steel Body and sealing nut with nylon 6/6 and TPE co-molded finger/gland assembly SBR Sealing Washer
Certifications	cULus Listed under Underwriters' Laboratories File E51579 cRAus Recognized under Underwriters' Laboratories File E51579
Flammability Rating	94V-2
Temperature Range	-40°F (-40°C) to 221°F (105°C)
IP Rating	IP68 (70 PSI, 5 BAR)

“Stay Connected” with



Liquid Tight Cordgrips

a PennEngineering® Company

HEYbrid™ Stainless Steel Hazardous Location Liquid Tight Cordgrips

Straight-Thru, NPT Hubs

Don't get SKU'ed: More Cable Range, Fewer SKU's – Genetically engineered to destroy your inventory monster!

The Ultimate in Liquid Tight Strain Relief Protection



CABLE DIA. RANGE				PART NO.	DESCRIPTION	UL or RA	NPT Tapped Hole*	PART DIMENSIONS							
Minimum		Maximum						A Max. O.A. Length	B Thread Length	C Wrenching Nut Thickness		D Wrenching Nut Flat Size			
in.	mm.	in.	mm.					in.	mm.	in.	mm.	in.	mm.	in.	mm.
HEYCo-molded Finger/Gland															
.095	2,4	.290	7,4	M6006E	RSSCG 1/2 EXP	cULus	1/2 - 14	2.07	52,6	.78	19,8	.20	5,1	1.06	27,0
.170	4,3	.450	11,4	M6007E	SSCG 1/2 EXP			2.18	55,4	.78	19,8	.20	5,1	1.25	31,2
.180	4,6	.400	10,1	M6008E	RSSCG LL1/2 EXP	cULus	1/2 - 14	2.34	59,4	.79	20,1	.20	5,1	1.31	33,3
.260	6,6	.545	13,8	M6009E	SSCG LL1/2 EXP			2.80	72,1	.99	25,1	.20	5,1	1.75	44,4
.250	6,4	.490	12,4	M6010E	RSSCG 3/4 EXP	cULus	3/4 - 14	2.80	72,1	.99	25,1	.20	5,1	1.75	44,4
.435	11,0	.705	17,9	M6011E	SSCG 3/4 EXP			2.80	72,1	.99	25,1	.20	5,1	1.75	44,4
.490	12,4	.785	19,9	M6012E	RSSCG 1 EXP	cULus	1 - 1 1/2	2.80	72,1	.99	25,1	.20	5,1	1.75	44,4
.590	15,0	1.000	25,4	M6013E	SSCG 1 EXP			2.80	72,1	.99	25,1	.20	5,1	1.75	44,4

*Hazardous Location SSCGs must be mounted in a tapped hole.

Hazardous Location SSCGs Certifications:

US Certifications:

Class I, Zone 1, AEx d IIC
Class II, Zone 21, AEx tb IIIC

CANADIAN Certifications:

Zone 1, Ex d IIC
Zone 21, Ex tb IIIC

ATEX/IECEX Certifications:

Ex II 2G; Ex d IIC Gb
Ex II 2D; Ex tb IIIC Db IP6X
Per Directive 2014/34/EU
CE 0539

Evaluated and Certified to:

UL Standards: UL 2225
IECEX Standards: IEC 60079-0; IEC 60079-1;
IEC 60079-31; IEC 60079-14
(installation-specific guidelines)
ATEX Standards: EN 60079-0:2012 +
A11:2013; EN60079-1: 2007;
EN 60079-31:2014

CSA Standards: CSA C22.2 NO. 60079-0-11;
CSA C22.2 NO. 60079-31-12; CSA C22.2
NO. 60079-1:11; CSA C22.2 NO. 30

- **HEYCo-molded gripping finger/gland technology** accommodates the **widest cable range** over the **fewest sku's**.
- Rolled grease-free threads **prevent galling** and allow for multiple assemblies and disassemblies. No messy, unsightly thread lubrication required.
- Typical applications: Oil and gas industry.
- For indoor or outdoor use.
- For use with non-armored extra hard usage cord.
- Ideal for corrosive environments.
- Constructed from corrosion resistant 303 stainless steel.
- Resistant to salt water, acids and most chemicals.
- For hazardous locations either of the following sealing compounds must be used (special order only).
KSL 225 - KSL epoxy sealing compound - 225 mL
CAP 82 - Chico A-P powder sealing compound - 82 mL
- Patent pending.
- DFARS Compliant

The HEYCo-molded Finger, Gland & Seat

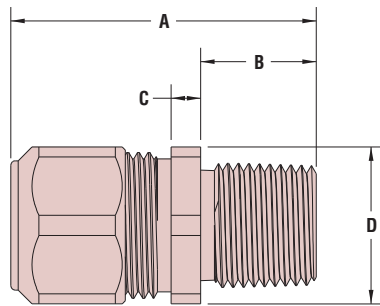
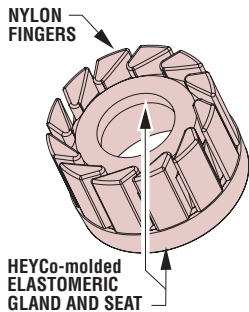

Material	303 Stainless Steel Body and sealing nut with nylon 6/6 and TPE co-molded finger/gland assembly SBR Sealing Washer
Certifications	cULus Listed under Underwriters' Laboratories File E466645 Ex US/UL/ExTR16.00947/00 and 16 ATEX 1541U Rev. 0 CE Per EN 60079-0:212 and A11:2013
Flammability Rating	94V-2
Temperature Range	-4°F (-20°C) to 140°F (60°C)
IP Rating	IP68 (70 PSI, 5 BAR)

“Stay Connected” with



Liquid Tight Cordgrips

a PennEngineering® Company



HEYbrid™ Stainless Steel Liquid Tight Cordgrips

Straight-Thru, Pg Hubs

Don't get SKU'ed: More Cable Range, Fewer SKU's –
Genetically engineered to destroy your inventory monster!
The Ultimate in Liquid Tight Strain Relief Protection

- HEYCo-molded gripping finger/gland technology accommodates the **widest cable range** over the **fewest sku's**.
- Rolled grease-free threads **prevent galling** and allow for multiple assemblies and disassemblies. No messy, unsightly thread lubrication required.
- Approved for **NEMA 4, 4X, 6 and 6P** applications.
- Self-retaining sealing rings eliminate the need for an O-Ring groove, thus **reducing cost**.
- Typical applications: Control cabinets, marine, car washes, hot tubs, instrumentation, carpet cleaning machines, food processing equipment, underground for direct burial or submersed up to 130 ft. (70 PSIG).
- Ideal for corrosive environments.
- Constructed from corrosion resistant 303 stainless steel.
- Resistant to salt water, acids and most chemicals.
- Locknuts not included. To order locknuts separately, see page 3-48.
- Patent pending.
- DFARS Compliant

CABLE DIA. RANGE				PART NO.	DESCRIPTION	or UL	PART DIMENSIONS									
Minimum		Maximum					A Clearance Hole Dia.	B Max. O.A. Length		C Thread Length		D Wrenching Nut Thickness		E Nut Flat Size		
in.	mm.	in.	mm.				in.	mm.	in.	mm.	in.	mm.	in.	mm.		
HEYCo-molded Finger/Gland																
.065	1,7	.210	5,3	M6030	RSSCG PG7	cULus	.492	12,5	1.24	31,5	.35	8,9	.20	5,1	.75	19,1
.115	2,9	.250	6,4	M6031	SSCG PG7											
.065	1,7	.230	5,8	M6032	RSSCG PG9	cULus	.599	15,2	1.31	33,3	.34	8,6	.20	5,1	.88	22,4
.105	2,7	.315	8,0	M6033	SSCG PG9											
.095	2,4	.290	7,4	M6036	RSSCG PG13.5	cULus	.804	20,4	1.58	40,1	.42	10,7	.20	5,1	1.06	26,9
.170	4,3	.450	11,4	M6037	SSCG PG13.5											
.180	4,6	.400	10,2	M6038	RSSCG PG16	cULus	.886	22,5	1.73	43,9	.45	11,4	.20	5,1	1.25	31,8
.260	6,6	.545	13,8	M6039	SSCG PG16											
.250	6,4	.490	12,4	M6040	RSSCG PG21	cULus	1.115	28,3	1.91	48,5	.53	13,5	.20	5,1	1.31	33,3
.435	11,0	.705	17,9	M6041	SSCG PG21											
.490	12,4	.785	19,9	M6042	RSSCG PG29	cULus	1.470	37,3	2.19	55,6	.59	15,0	.20	5,1	1.75	44,5
.590	15,0	1.000	25,4	M6043	SSCG PG29											

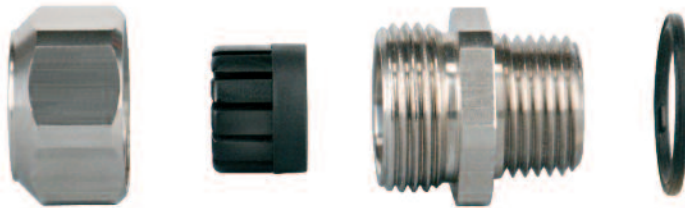

The HEYCo-molded Finger, Gland & Seat

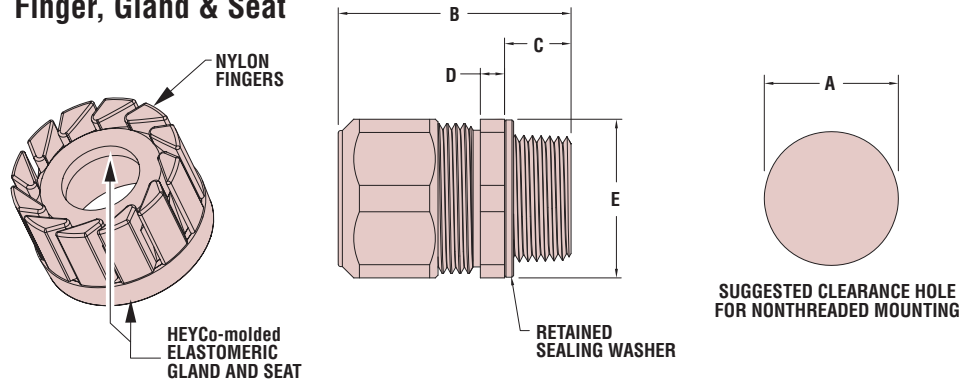

Quick
Specs

Material	303 Stainless Steel Body and sealing nut with nylon 6/6 and TPE co-molded finger/gland assembly SBR Sealing Washer
Certifications	cULus Listed under Underwriters' Laboratories File E51579 cULus Recognized under Underwriters' Laboratories File E51579
Flammability Rating	94V-2
Temperature Range	-40°F (-40°C) to 221°F (105°C)
IP Rating	IP68 (70 PSI, 5 BAR)

“Stay Connected” with



Liquid Tight Cordgrips

a PennEngineering® Company

HEYbrid™ Stainless Steel Liquid Tight Cordgrips

Straight-Thru, Metric Hubs

Don't get SKU'ed: More Cable Range, Fewer SKU's –
Genetically engineered to destroy your inventory monster!
The Ultimate in Liquid Tight Strain Relief Protection



CABLE DIA. RANGE				PART NO.	DESCRIPTION	UL or IEC	PART DIMENSIONS									
Minimum		Maximum					A	B	C	D		E				
in.	mm.	in.	mm.			Clearance Hole Dia.	Max. O.A. Length	Thread Length	Wrenching Nut Thickness		Flat Size					
						in.	mm.	in.	mm.	in.	mm.	in.	mm.			
HEYCo-molded Finger/Gland																
.065	1,7	.210	5,3	M6060	RSSCG M12	cULus	.473	12,0	1.23	31,2	.34	8,6	.20	5,1	.75	19,1
.115	2,9	.250	6,4	M6061	SSCG M12	cULus										
.065	1,7	.230	5,8	M6062	RSSCG M16	cULus	.630	16,0	1.31	33,3	.34	8,6	.20	5,1	.88	22,4
.105	2,7	.315	8,0	M6063	SSCG M16	cULus										
.095	2,4	.290	7,4	M6066	RSSCG M20	cULus	.787	20,0	1.58	42,9	.42	13,5	.20	5,1	1.06	26,9
.170	4,3	.450	11,4	M6067	SSCG M20	cULus										
.180	4,6	.400	10,2	M6068	RSSCG LL M20	cULus	.787	20,0	1.70	43,2	.42	10,7	.20	5,1	1.25	31,8
.260	6,6	.545	13,8	M6069	SSCG LL M20	cULus										
.250	6,4	.490	12,4	M6070	RSSCG M25	cULus	.985	25,0	1.91	48,5	.53	13,5	.20	5,1	1.31	33,3
.435	11,0	.705	17,9	M6071	SSCG M25	cULus										
.490	12,4	.785	19,9	M6072	RSSCG M32	cULus	1.260	32,0	2.19	55,6	.59	15,0	.20	5,1	1.75	44,5
.590	15,0	1.000	25,4	M6073	SSCG M32	cULus										

- HEYCo-molded gripping finger/gland technology accommodates the **widest cable range** over the **fewest sku's**.
- Rolled grease-free threads **prevent galling** and allow for multiple assemblies and disassemblies. No messy, unsightly thread lubrication required.
- Approved for **NEMA 4, 4X, 6 and 6P** applications.
- Self-retaining sealing rings eliminate the need for an O-Ring groove, thus **reducing cost**.
- Typical applications: Control cabinets, marine, car washes, hot tubs, instrumentation, carpet cleaning machines, food processing equipment, underground for direct burial or submersed up to 130 ft. (70 PSIG).
- Ideal for corrosive environments.
- Constructed from corrosion resistant 303 stainless steel.
- Resistant to salt water, acids and most chemicals.
- Locknuts not included. To order locknuts separately, see page 3-48.
- Patent pending.
- DFARS Compliant

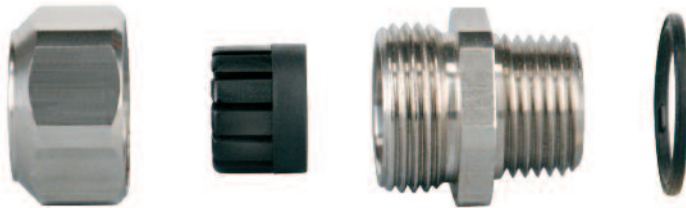

The HEYCo-molded Finger, Gland & Seat

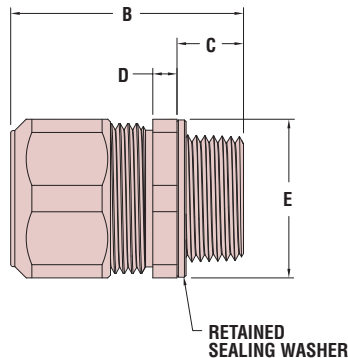
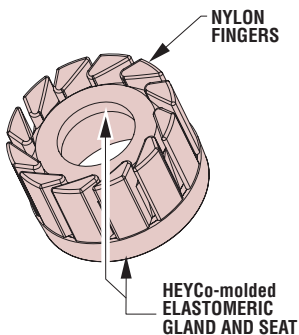

SUGGESTED CLEARANCE HOLE FOR NONTHEADED MOUNTING

Material	303 Stainless Steel Body and sealing nut with nylon 6/6 and TPE co-molded finger/gland assembly SBR Sealing Washer
Certifications	cULus Listed under Underwriters' Laboratories File E51579 cULus Recognized under Underwriters' Laboratories File E51579
Flammability Rating	94V-2
Temperature Range	-40°F (-40°C) to 221°F (105°C)
IP Rating	IP68 (70 PSI, 5 BAR)

Quick Specs

“Stay Connected” with



Liquid Tight Cordgrips

a PennEngineering® Company



HEYbrid™ Plated Steel Liquid Tight Cordgrips

Straight-Thru, NPT Hubs

Don't get SKU'ed: More Cable Range, Fewer SKU's – Genetically engineered to destroy your inventory monster!

The Ultimate in Liquid Tight Strain Relief Protection



- **HEYCo-molded gripping finger/gland technology** accommodates the **widest cable range** over the **fewest sku's**.
- Rolled grease-free threads **prevent galling** and allow for multiple assemblies and disassemblies. No messy, unsightly thread lubrication required.
- Approved for **NEMA 4, 4X, 6 and 6P** applications.
- Self-retaining sealing rings eliminate the need for an O-Ring groove, thus **reducing cost**.
- Sealing washer required for through hole applications only.
- Typical applications: Control cabinets, car washes, hot tubs, instrumentation, carpet cleaning machines, underground for direct burial or submersed up to 130 ft. (70 PSIG).
- Constructed from corrosion resistant Zinc Plated steel.
- Resistant to salt water, acids and most chemicals.
- Patent pending.
- DFARS Compliant

CABLE DIA. RANGE				PART NO.	DESCRIPTION	UL or RA	PART DIMENSIONS									
Minimum		Maximum					A Clearance Hole Dia.	B Max. O.A. Length	C Thread Length	D Wrenching Nut Thickness		E Wrenching Nut Flat Size				
in.	mm.	in.	mm.				in.	mm.	in.	mm.	in.	mm.	in.	mm.		
HEYCo-molded Finger/Gland																
.065	1,7	.210	5,3	M6200	RPSCG 1/4	cULus	.540	13,7	1.29	32,8	.40	13,2	.20	5,1	.75	19,1
.115	2,9	.250	6,4	M6201	PSCG 1/4	cULus	.540	13,7	1.29	32,8	.40	13,2	.20	5,1	.75	19,1
.065	1,7	.230	5,8	M6202	RPSCG 3/8	cULus	.680	17,3	1.39	35,3	.41	10,4	.20	5,1	.88	22,4
.105	2,7	.315	8,0	M6203	PSCG 3/8	cULus	.680	17,3	1.39	35,3	.41	10,4	.20	5,1	.88	22,4
.095	2,4	.290	7,4	M6206	RPSCG 1/2	cULus	.875	22,2	1.69	42,9	.53	13,5	.20	5,1	1.06	26,9
.170	4,3	.450	11,4	M6207	PSCG 1/2	cULus	.875	22,2	1.69	42,9	.53	13,5	.20	5,1	1.06	26,9
.180	4,6	.400	10,1	M6208	RPSCG LL 1/2	cULus	.875	22,2	1.81	46,0	.53	13,5	.20	5,1	1.25	31,8
.260	6,6	.545	13,8	M6209	PSCG LL 1/2	cULus	.875	22,2	1.81	46,0	.53	13,5	.20	5,1	1.25	31,8
.250	6,4	.490	12,4	M6210	RPSCG 3/4	cULus	1.109	28,2	1.93	49,0	.55	14,0	.20	5,1	1.31	33,3
.435	11,0	.705	17,9	M6211	PSCG 3/4	cULus	1.109	28,2	1.93	49,0	.55	14,0	.20	5,1	1.31	33,3
.490	12,4	.785	19,9	M6212	RPSCG 1	cULus	1.375	34,9	2.29	58,1	.69	17,5	.20	5,1	1.75	44,5
.590	15,0	1.000	25,4	M6213	PSCG 1	cULus	1.375	34,9	2.29	58,1	.69	17,5	.20	5,1	1.75	44,5
Discrete Finger & Gland																
.787	20,0	1.020	26,0	M6215	RPSCG 1-1/4	cULus	1.734	44,0	2.56	65,0	.71	18,0	.25	6,4	2.25	57,2
.865	22,0	1.260	32,0	M6216	PSCG 1-1/4	cULus	1.734	44,0	2.56	65,0	.71	18,0	.25	6,4	2.25	57,2
1.000	25,4	1.240	31,5	M6217	RPSCG 1-1/2	cULus	1.984	50,4	2.69	67,1	.73	18,5	.25	6,4	2.50	63,5
1.230	31,2	1.560	39,6	M6218	PSCG 1-1/2	cULus	1.984	50,4	2.69	67,1	.73	18,5	.25	6,4	2.50	63,5
1.160	29,5	1.350	34,3	M6219	RPSCG 2	cULus	2.469	62,7	2.92	74,2	.76	19,3	.25	6,4	2.75	69,9
1.450	36,8	1.730	44,0	M6220	PSCG 2	cULus	2.469	62,7	2.92	74,2	.76	19,3	.25	6,4	2.75	69,9

The HEYCo-molded Finger, Gland & Seat

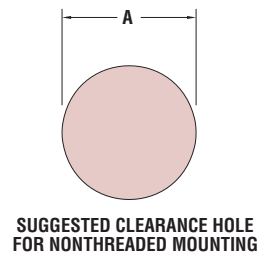
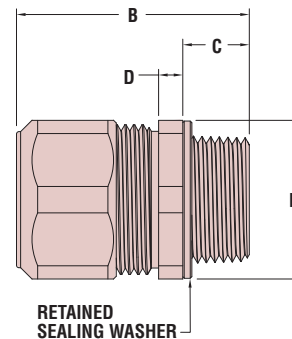
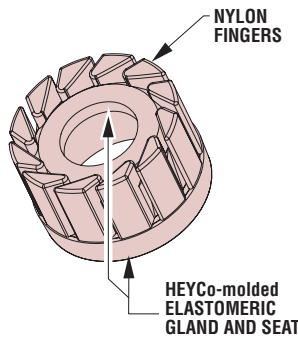

Quick Specs

Material	Zinc Plated Steel Body and sealing nut with nylon 6/6 and TPE co-molded finger/gland assembly SBR Sealing Washer
Certifications	cULus Listed under Underwriters' Laboratories File E51579 cRAus Recognized under Underwriters' Laboratories File E51579
Flammability Rating	94V-2
Temperature Range	-40°F (-40°C) to 221°F (105°C)
IP Rating	IP68 (70 PSI, 5 BAR)

“Stay Connected” with



Liquid Tight Cordgrips

a PennEngineering® Company

Heyco® -Tite Metallic Liquid Tight Cordgrips

Straight-Thru, NPT Hubs

The Ultimate in Liquid Tight Strain Relief Protection



CABLE DIA. RANGE				PART NO.	DESC.	Gland Color	NPT HUB SIZE	PART DIMENSIONS											
Minimum		Maximum						A	B	C	D	E	Clearance Hole Dia.		Sealing Nut HEX		Body Nut O.D.		Overall Length*
in.	mm.	in.	mm.					in.	mm.	in.	mm.	in.	mm.	in.	mm.	in.	mm.	in.	mm.
Steel																			
.150	3,8	.250	6,3	9760	CG 50A-250	Red													
.250	6,3	.350	8,9	9761	CG 50A-350	White													
.350	8,9	.450	11,4	9762	CG 50A-450	Blue	1/2	.875	22,2	1.031	26,2	.937	23,8	1.312	33,3	.812	20,6		
.450	11,4	.550	14,2	9763	CG 50A-560	Green													
.550	14,0	.650	16,5	9764	CG 50A-650	Brown													
.150	3,8	.250	6,3	9766	CG 75A-250	Red													
.250	6,3	.350	8,9	9767	CG 75A-350	White													
.350	8,9	.450	11,4	9769	CG 75A-450	Blue	3/4	1.109	28,2	1.031	26,2	1.172	29,8	1.312	33,3	.812	20,6		
.450	11,4	.550	14,2	9770	CG 75A-560	Green													
.550	14,0	.650	16,5	9771	CG 75A-650	Brown													
.650	16,5	.750	19,0	9772	CG 75B-750	Yellow	3/4	1.109	28,2	1.250	31,7	1.187	31,2	1.562	39,7	1.031	26,2		
.750	19,0	.850	21,6	9773	CG 75B-850	Purple													
Zinc Die-Cast																			
.190	4,8	.250	6,3	9776	CG 11														
.260	6,6	.375	9,5	9777	CG 12	N/A	1/2	.875	22,2	1.00	25,4	.94	23,8	1.20	30,5	.80	20,3		
.375	9,5	.450	11,4	9778	CG 13														

*May vary slightly depending on cable diameter.

Steel:

- Zinc plated steel construction for superior protection of flexible cables.
- Compact design allows fittings to be consecutively ganged—no skipping knockouts—and occupy less real estate.
- Galvanized steel pressure ring prevents distortion of the grommet when the sealing nut is tightened.
- Neoprene rubber grommet ensures a permanent rain-tight seal around the cable.
- Body and sealing nut are made of corrosion resistant machined steel. Zinc plated with special brighteners for an attractive finish.
- Color coded label system identifies the cordgrips by wire range/grommet opening.
- For use in clearance or threaded holes.
- Multiple cable sizes with 1/2" to 3/4" NPT hubs, cover a flexible cord diameter range of .150" (3,8 mm) to .850" (21,6 mm).
- Temperature Rating: 221°F (105°C).
- DFARS Compliant

Steel

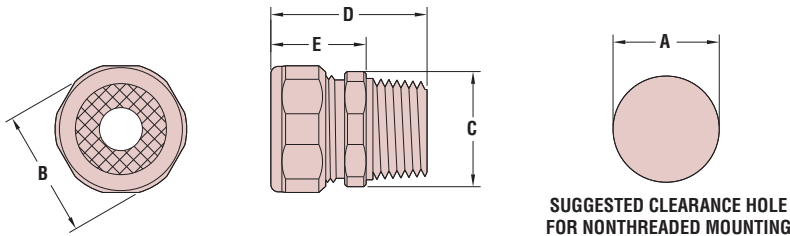

Zinc Die-Cast

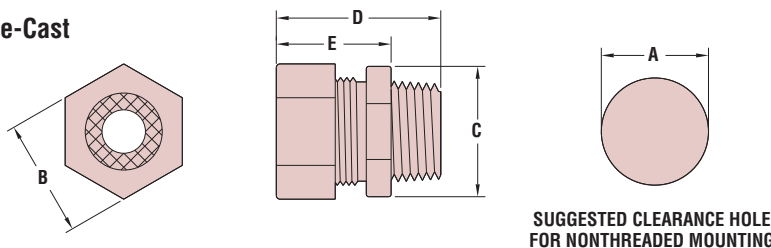

Zinc Die-Cast:

- Zamac #3 construction for protection of flexible cables.
- For use in clearance or threaded holes.
- We recommend using the smallest maximum diameter range cordgrip that will fit your application.
- Temperature Rating: 140°F (60°C).
- DFARS Compliant



Heyco® -Tite Aluminum Liquid Tight Cordgrips

Straight-Thru, NPT Hubs

The Ultimate in Liquid Tight Strain Relief Protection

- **Aluminum construction** provides excellent durability and performance for most **industrial applications**.
- For use in both indoor and outdoor applications to prevent cable pull-out, control arc of bend, and to provide a tight seal against environmental elements such as dirt, moisture, and coolants.
- IP 67 rated.
- Protect cable from damage and pull-out and are used in conduit hubs or knock-outs at the point where the electrical cable is to be terminated.
- Unique design with a combination tightening surface that includes both a hex area and a knurled surface.
- Anti-friction washer allows for easier compression.
- DFARS Compliant

CABLE DIA. RANGE				PART NO. Machined Aluminum	THREAD SIZE	UL	PART DIMENSIONS							
Minimum		Maximum					A Clearance Hole Dia.		B Max. O.A. Length		C Thread Length		D Wrenching Flat Size	
in.	mm.	in.	mm.				in.	mm.	in.	mm.	in.	mm.		
.125	3,2	.188	4,8	M5000*	NPT 1/4	UL	.54	13,7	1.38	35,1	.44	11,2	.88	22,4
.188	4,8	.250	6,4	M5001										
.250	6,4	.312	7,9	M5002										
.312	7,9	.375	9,5	M5003										
.125	3,2	.188	4,8	M5005*	NPT 3/8	UL	.68	17,3	1.38	35,1	.44	11,2	.88	22,4
.188	4,8	.250	6,4	M5006										
.250	6,4	.312	7,9	M5007										
.312	7,9	.375	9,5	M5008										
.125	3,2	.188	4,8	M5010*	NPT 1/2	UL	.88	22,4	1.38	35,1	.44	11,2	.88	22,4
.188	4,8	.250	6,4	M5011										
.250	6,4	.312	7,9	M5012										
.312	7,9	.375	9,5	M5013										
.375	9,5	.438	11,1	M5014										
.125	3,2	.188	4,8	M5015*	NPT 1/2	UL	.88	22,4	1.62	41,1	.56	14,2	1.13	28,7
.188	4,8	.250	6,4	M5016										
.250	6,4	.312	7,9	M5017										
.312	7,9	.375	9,5	M5018										
.375	9,5	.438	11,1	M5019										
.438	11,1	.500	12,7	M5020										
.500	12,7	.562	14,3	M5021										
.562	14,3	.625	15,9	M5022										

Assembled O-ring **INCLUDED**. *Not UL Listed or CSA Certified.
Locknut not included - See page 3-48 for Metal Locknuts.

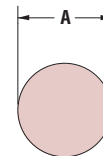
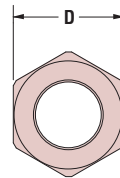
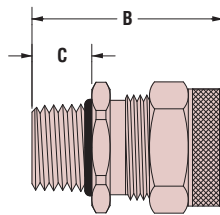

SUGGESTED CLEARANCE HOLE FOR NONTHREADED MOUNTING

Quick Specs

Material
Certifications

Aluminum with Neoprene Sealing Gland and Viton® O-Ring
 UL Listed under Underwriters' Laboratories File E51579
 SR Certified by Canadian Standard Association File 258093

Flammability Rating
Temperature Range
IP Rating

94V-2
-40°F (-40°C) to 250°F (121°C)
IP 67

“Stay Connected” with



Liquid Tight Cordgrips

a PennEngineering® Company



Heyco® -Tite Aluminum Liquid Tight Cordgrips

Straight-Thru, NPT Hubs

The Ultimate in Liquid Tight Strain Relief Protection

CABLE DIA. RANGE				PART NO. Machined Aluminum	THREAD SIZE	UL	PART DIMENSIONS							
Minimum		Maximum					A Clearance Hole Dia.		B Max. O.A. Length		C Thread Length		D Wrenching Flat Size	
in.	mm.	in.	mm.				in.	mm.	in.	mm.	in.	mm.	in.	mm.
.125	3,2	.188	4,8	M5029	NPT 3/4	UL	1.09	27,7	1.62	41,1	.56	14,2	1.13	28,7
.188	4,8	.250	6,4	M5030										
.250	6,4	.312	7,9	M5031										
.312	7,9	.375	9,5	M5032										
.375	9,5	.438	11,1	M5033										
.438	11,1	.500	12,7	M5034										
.500	12,7	.562	14,3	M5035										
.562	14,3	.625	15,9	M5036										
.438	11,1	.500	12,7	M5037	NPT 3/4	UL	1.09	27,7	1.82	46,2	.56	14,2	1.37	34,8
.500	12,7	.562	14,3	M5038										
.562	14,3	.625	15,9	M5039										
.562	14,3	.688	17,5	M5040										
.625	15,9	.750	19,1	M5041										
.688	17,5	.812	20,6	M5042										
.438	11,1	.562	14,3	M5050										
.562	14,3	.625	15,9	M5051										
.562	14,3	.688	17,5	M5052										
.625	15,9	.750	19,1	M5053										
.688	17,5	.812	20,6	M5054										
.750	19,1	.875	22,2	M5055										
.812	20,6	.938	23,8	M5056										
.875	22,2	1.000	25,4	M5057*										
.875	22,2	1.000	25,4	M5058	NPT 1	UL	1.38	35,1	2.50	63,5	.69	17,5	2.25	57,2
1.000	25,4	1.125	28,6	M5059										
1.125	28,6	1.250	31,8	M5060										
1.250	31,8	1.375	34,9	M5061										
.562	14,3	.688	17,5	M5062										
.688	17,5	.812	20,6	M5063	NPT 1-1/4	UL	1.72	43,7	2.50	63,5	.69	17,5	2.25	57,2
.750	19,1	.875	22,2	M5064										
.875	22,2	1.000	25,4	M5065										
1.000	25,4	1.125	28,6	M5066										
1.125	28,6	1.250	31,8	M5067										
1.250	31,8	1.375	34,9	M5068										

Assembled O-ring **INCLUDED**. *Not UL Listed or CSA Certified.
Locknut not included - See page 3-48 for Metal Locknuts.

- **Aluminum construction** provides excellent durability and performance for most **industrial applications**.
- For use in both indoor and outdoor applications to prevent cable pull-out, control arc of bend, and to provide a tight seal against environmental elements such as dirt, moisture, and coolants.
- IP 67 rated.
- Protect cable from damage and pull-out and are used in conduit hubs or knock-outs at the point where the electrical cable is to be terminated.
- Unique design with a combination tightening surface that includes both a hex area and a knurled surface.
- Anti-friction washer allows for easier compression.
- DFARS Compliant

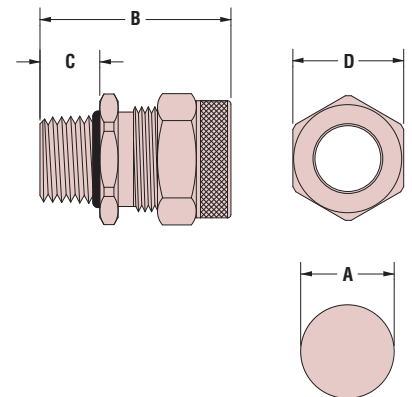

SUGGESTED CLEARANCE HOLE FOR NONTHEADED MOUNTING

Material	Aluminum with Neoprene Sealing Gland and Viton® O-Ring
Certifications	UL Listed under Underwriters' Laboratories File E51579 CSA Certified by Canadian Standard Association File 258093
Flammability Rating	94V-2
Temperature Range	-40°F (-40°C) to 250°F (121°C)
IP Rating	IP 67

Quick Specs

“Stay Connected” with



Liquid Tight Cordgrips

a PennEngineering® Company



Heyco® -Tite Aluminum Liquid Tight Cordgrips

Straight-Thru, NPT Hubs

The Ultimate in Liquid Tight Strain Relief Protection

- **Aluminum construction** provides excellent durability and performance for most **industrial applications**.
- For use in both indoor and outdoor applications to prevent cable pull-out, control arc of bend, and to provide a tight seal against environmental elements such as dirt, moisture, and coolants.
- IP 67 rated.
- Protect cable from damage and pull-out and are used in conduit hubs or knock-outs at the point where the electrical cable is to be terminated.
- Unique design with a combination tightening surface that includes both a hex area and a knurled surface.
- Anti-friction washer allows for easier compression.
- DFARS Compliant

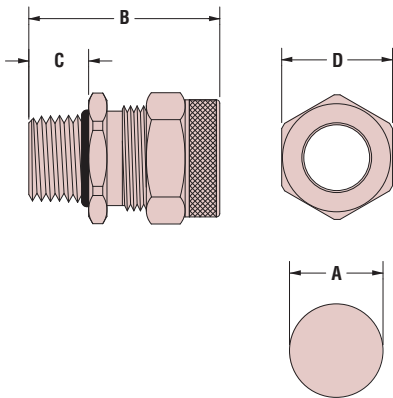

SUGGESTED CLEARANCE HOLE FOR NONTHREADED MOUNTING

CABLE DIA. RANGE				PART NO. Machined Aluminum	THREAD SIZE	UL	PART DIMENSIONS														
Minimum		Maximum					A Clearance Hole Dia.		B Max. O.A. Length		C Thread Length		D Wrenching Flat Size								
in.	mm.	in.	mm.				in.	mm.	in.	mm.	in.	mm.	in.	mm.							
Machined Aluminum																					
.562	14,3	.688	17,5	M5069*	NPT 1-1/2	UL	1.97	50,0	2.50	63,5	.69	17,5	2.25	57,2							
.688	17,5	.812	20,6	M5070																	
.750	19,1	.875	22,2	M5071																	
.875	22,2	1.000	25,4	M5072																	
1.000	25,4	1.125	28,6	M5073																	
1.125	28,6	1.250	31,8	M5074																	
1.250	31,8	1.375	34,9	M5075																	
1.250	31,8	1.375	34,9	M5080	NPT 2	UL	2.46	62,5	3.12	79,2	.80	20,3	2.83	71,9							
1.312	33,3	1.437	36,5	M5081																	
1.438	36,5	1.562	39,7	M5082																	
1.562	39,7	1.688	42,9	M5083																	
1.688	42,9	1.812	46,0	M5084																	
Cast Aluminum																					
1.688	42,9	1.812	46,0	M5091											NPT 2-1/2	UL	2.96	75,2	4.20	106,7	1.28
1.812	46,0	1.938	49,2	M5092																	
1.938	49,2	2.062	52,4	M5093																	
2.062	52,4	2.188	55,6	M5094																	
2.188	55,6	2.312	58,7	M5095																	
2.312	58,7	2.438	61,9	M5096																	
1.688	42,9	1.812	46,0	M5097	NPT 3	UL	3.58	90,9	4.20	106,7	1.31	33,3	4.00	101,6							
1.812	46,0	1.938	49,2	M5098																	
1.938	49,2	2.062	52,4	M5099																	
2.062	52,4	2.188	55,6	M5100																	
2.188	55,6	2.312	58,7	M5101																	
2.312	58,7	2.438	61,9	M5102																	
2.437	61,9	2.625	66,7	M5103											NPT 3	*	3.50	88,9	4.85	123,2	1.39
2.625	66,7	2.812	71,4	M5104																	
2.812	71,4	3.000	76,2	M5105																	
3.000	76,2	3.250	82,6	M5106																	

Assembled O-ring **INCLUDED**. *Not UL Listed or CSA Certified.
Locknut not included - See page 3-48 for Metal Locknuts.

Quick Specs

Material
Certifications

Aluminum with Neoprene Sealing Gland and Viton® O-Ring
UL Listed under Underwriters' Laboratories File E51579
CSA Certified by Canadian Standard Association File 258093

Flammability Rating
Temperature Range
IP Rating

94V-2
-40°F (-40°C) to 250°F (121°C)
IP 67

“Stay Connected” with



Liquid Tight Cordgrips

a PennEngineering® Company



HEYbrid™ Aluminum Liquid Tight Cordgrips

Straight-Thru, NPT Hubs

Don't get SKU'ed: More Cable Range, Fewer SKU's!

Genetically engineered to destroy your inventory monster!

The Ultimate in Liquid Tight Strain Relief Protection

ALL NEW PRODUCTS!

CABLE DIA. RANGE				PART NO.	DESCRIPTION	UL or RA	PART DIMENSIONS									
Minimum		Maximum					Machined Aluminum	A		B		C		D		E
in.	mm.	in.	mm.		Clearance Hole Dia.	Max. O.A. Length		Thread Length	Thickness	Wrenching Nut Flat Size	in.	mm.	in.	mm.	in.	mm.
HEYCo-molded Finger/Gland																
.065	1,7	.210	5,3	M6100	RALCG 1/4	cULus	.540	13,7	1.29	32,8	.40	13,2	.20	5,1	.75	19,1
.115	2,9	.250	6,4	M6101	ALCG 1/4											
.065	1,7	.230	5,8	M6102	RALCG 3/8	cULus	.680	17,3	1.39	35,3	.41	10,4	.20	5,1	.88	22,4
.105	2,7	.315	8,0	M6103	ALCG 3/8											
.095	2,4	.290	7,4	M6106	RALCG 1/2	cULus	.875	22,2	1.69	42,9	.53	13,5	.20	5,1	1.06	26,9
.170	4,3	.450	11,4	M6107	ALCG 1/2											
.180	4,6	.400	10,1	M6108	RALCG LL 1/2	cULus	.875	22,2	1.81	46,0	.53	13,5	.20	5,1	1.25	31,8
.260	6,6	.545	13,8	M6109	ALCG LL 1/2											
.250	6,4	.490	12,4	M6110	RALCG 3/4	cULus	1.109	28,2	1.93	49,0	.55	14,0	.20	5,1	1.31	33,3
.435	11,0	.705	17,9	M6111	ALCG 3/4											
.490	12,4	.785	19,9	M6112	RALCG 1	cULus	1.375	34,9	2.29	58,1	.69	17,5	.20	5,1	1.75	44,5
.590	15,0	1.000	25,4	M6113	ALCG 1											
Discrete Finger & Gland																
.787	20,0	1.02	26,0	M6115	RALCG 1-1/4	cULus	1.734	44,0	2.56	65,0	.71	18,0	.25	6,4	2.25	57,2
.865	22,0	1.26	32,0	M6116	ALCG 1-1/4											
1.00	25,4	1.24	31,5	M6117	RALCG 1-1/2	cULus	1.984	50,4	2.69	67,1	.73	18,5	.25	6,4	2.50	63,5
1.23	31,2	1.56	39,6	M6118	ALCG 1-1/2											
1.16	29,5	1.35	34,3	M6119	RALCG 2	cULus	2.469	62,7	2.92	74,2	.76	19,3	.25	6,4	2.75	69,9
1.45	36,8	1.73	44,0	M6120	ALCG 2											

Assembled O-ring **INCLUDED**.

Locknut not included - see page 3-48 for Metal Locknuts

- HEYCo-molded gripping finger/gland technology accommodates the **widest cable range** over the **fewest sku's**.
- Rolled grease-free threads **prevent galling** and allow for multiple assemblies and disassemblies. No messy, unsightly thread lubrication required.
- Approved for **NEMA 4, 4X, 6 and 6P**.
- Self-retaining sealing rings eliminate the need for an O-Ring groove, thus **reducing cost**.
- **Aluminum construction** provides excellent durability and performance for most **industrial applications**.
- For use in both indoor and outdoor applications to prevent cable pull-out, control arc of bend, and to provide a tight seal against environmental elements such as dirt, moisture, and coolants.
- Sealing washer required for through hole applications only.
- DFARS Compliant

The HEYCo-molded Finger, Gland & Seat

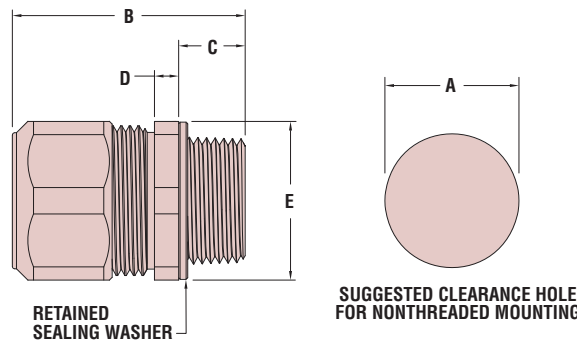
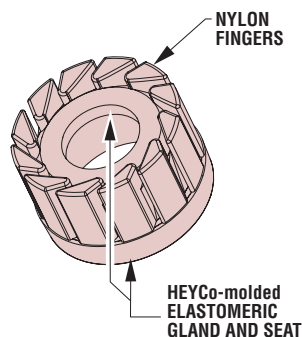

Material	6061 Aluminum Body and sealing nut with nylon 6/6 and TPE co-molded finger/gland assembly SBR Sealing Washer
Certifications	cULus Listed under Underwriters' Laboratories File E51579 to both Canadian and U.S. requirements cRAus Recognized under Underwriters' Laboratories File E51579 to both Canadian and U.S. requirements
Flammability Rating	94V-2
Temperature Range	-40°F (-40°C) to 221°F (105°C)
IP Rating	IP68 (70 PSI, 5 BAR)

Quick Specs

“Stay Connected” with



Liquid Tight Cordgrips

a PennEngineering® Company



Heyco®-Tite Cast Aluminum Liquid Tight Cordgrips Right Angle, NPT Hubs

The Ultimate in Liquid Tight Strain Relief Protection

- **Aluminum construction** provides excellent durability and performance for most **industrial applications**.
- For use in both indoor and outdoor applications to prevent cable pull-out, control arc of bend, and to provide a tight seal against environmental elements such as dirt, moisture, and coolants.
- IP 67 rated.
- Protect cable from damage and pull-out and are used in conduit hubs or knock-outs at the point where the electrical cable is to be terminated.
- Unique design with a combination tightening surface that includes both a hex area and a knurled surface.
- Anti-friction washer allows for easier compression.
- DFARS Compliant

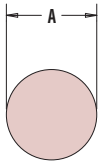

SUGGESTED CLEARANCE HOLE FOR NONTHREADED MOUNTING

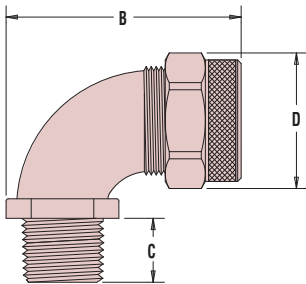

CABLE DIA. RANGE				PART NO. Cast Aluminum	THREAD SIZE	UL	PART DIMENSIONS							
Minimum		Maximum					A Clearance Hole Dia.		B Max. O.A. Length		C Thread Length		D Wrenching Flat Size	
in.	mm.	in.	mm.			in.	mm.	in.	mm.	in.	mm.	in.	mm.	
Sweep Design														
.125	3,2	.188	4,8	M5230	NPT 3/8	UL	.68	17,3	2.00	50,8	.44	11,2	.88	23,4
.188	4,8	.250	6,4	M5231										
.250	6,4	.312	7,9	M5232										
.312	7,9	.375	9,5	M5233										
.375	9,5	.438	11,1	M5234	NPT 1/2	UL	.88	22,3	2.39	60,7	.56	14,2	1.13	28,7
.125	3,2	.188	4,8	M5235										
.188	4,8	.250	6,4	M5236										
.250	6,4	.312	7,9	M5237										
.312	7,9	.375	9,5	M5238										
.375	9,5	.438	11,1	M5239										
.438	11,1	.500	12,7	M5240										
.500	12,7	.562	14,3	M5241										
.562	14,3	.625	15,9	M5242	NPT 3/4	UL	1.09	27,7	2.88	73,2	.59	15,0	1.37	31,8
.438	11,1	.500	12,7	M5243										
.500	12,7	.562	14,3	M5244										
.500	12,7	.625	15,9	M5245										
.562	14,3	.688	17,5	M5246										
.625	15,9	.750	19,1	M5247										
.688	17,5	.812	20,6	M5248	NPT 1	UL	1.38	35,0	3.13	79,5	.60	15,2	1.56	39,6
.500	12,7	.562	14,3	M5249										
.500	12,7	.625	15,9	M5250										
.562	14,3	.688	17,5	M5251										
.625	15,9	.750	19,1	M5252										
.688	17,5	.812	20,6	M5253										
.750	19,1	.875	22,2	M5254										
.812	20,6	.938	23,8	M5255										
.875	22,2	1.000	25,4	M5256										

O-ring not included - See pages 2-19 through 2-20 for Sealing Washers, Foam Washers & Thermoplastic O-rings.
Locknut not included - See page 3-48 for Metal Locknuts.

Quick
Specs

Material
Certifications



Aluminum with Neoprene Sealing Gland and Viton® O-Ring
Listed under Underwriters' Laboratories File E51579



Certified by Canadian Standard Association File 258093

Flammability Rating
Temperature Range
IP Rating

94V-2
-40°F (-40°C) to 250°F (121°C)
IP 67

“Stay Connected” with



Liquid Tight Cordgrips

a PennEngineering® Company

Heyco® -Tite Brass Liquid Tight Cordgrips

Straight Thru, NPT Hubs

The Ultimate in Liquid Tight Strain Relief Protection

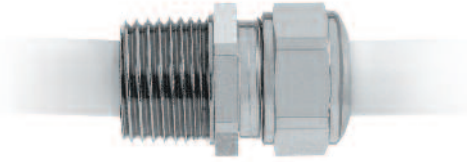

CABLE DIA. RANGE				PART NO.	THREAD SIZE	UL or RA	PART DIMENSIONS							
Minimum		Maximum					A Clearance Hole Dia.		B Max. O.A. Length		C Thread Length		D Wrenching Nut Flat Size	
in.	mm.	in.	mm.				in.	mm.	in.	mm.	in.	mm.	in.	mm.
.118	3,0	.157	4,0	4560	NPT 1/8	cULus	.445	11,3	.91	23,0	.31	8,0	.51	13,0
.157	4,0	.236	6,0	4561										
.138	3,5	.197	5,0	4562	NPT 1/4	cULus	.540	13,7	1.14	29,0	.47	12,0	.59	15,0
.197	5,0	.256	6,5	4563										
.256	6,5	.315	8,0	4564										
.138	3,5	.177	4,5	4565	NPT 3/8	cULus	.680	17,3	1.26	32,0	.47	12,0	.71	18,0
.177	4,5	.236	6,0	4566										
.236	6,0	.315	8,0	4567										
.315	8,0	.413	10,5	4568	NPT 3/8	cULus	.680	17,3	1.34	34,0				
.236	6,0	.315	8,0	4569	NPT 1/2	cULus	.875	22,2	1.42	36,0	.59	15,0	.94	24,0
.315	8,0	.433	11,0	4570										
.433	11,0	.591	15,0	4571	NPT 1/2	cULus	.875	22,2	1.50	38,0				
.374	9,5	.492	12,5	4572	NPT 3/4	cULus	1.040	26,4	1.69	43,0	.59	15,0	1.18	30,0
.492	12,5	.630	16,0	4573										
.630	16,0	.807	20,5	4574										
.551	14,0	.669	17,0	4575	NPT 1	cULus	1.326	33,7	1.89	48,0	.79	20,0	1.42	36,0
.669	17,0	.827	21,0	4576										
.827	21,0	1.004	25,5	4577										
.787	20,0	.945	24,0	4578	NPT 1-1/4	cULus	1.680	42,7	2.01	51,0	.79	20,0	1.81	46,0
.945	24,0	1.122	28,5	4579										
1.122	28,5	1.299	33,0	4580										
1.142	29,0	1.299	33,0	4581	NPT 1-1/2	cULus	1.920	48,8	2.20	56,0	.87	22,0	2.17	55,0
1.299	33,0	1.457	37,0	4582										
1.457	37,0	1.614	41,0	4583										
1.378	35,0	1.575	40,0	4584	NPT 2	cULus	2.400	61,0	2.32	59,0	.87	22,0	2.76	70,0
1.575	40,0	1.811	46,0	4585										
1.811	46,0	2.047	52,0	4586										

- Nickel plated brass construction for superior protection of flexible cables.
- Nickel-plated finish over brass provides excellent corrosion resistance and durability.
- IP 68 rated.
- For use in clearance or threaded holes.
- Long NPT threads provide additional threads for easy locknut assembly.
- Multiple sizes for flexible cord diameters ranging from .118" (3,0 mm) to 2.047" (52,0 mm).
- We recommend using the smallest cordgrip that accommodates your cable size.
- Sealing gland is molded in Thermoplastic Polymer Elastomer (TPE) Material.
- **Locknuts not included.** For metal locknut specifications or to order locknuts separately, see page 3-48.
- DFARS Compliant

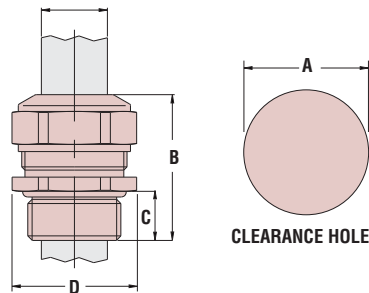

Material	Nickel-Plated Brass w/TPE Sealing Gland
Certifications	cULus Certified by UL for Compliance with both Canadian and U.S. requirements Under File E51579.
	cRAus Recognized under the Component Program of Underwriters' Laboratories File E51579 to both Canadian and U.S. requirements.
Temperature Range	-40°F (-40°C) to 212°F (100°C)
IP Rating	IP 68, IP 69K

Quick Specs

“Stay Connected” with



Liquid Tight Cordgrips

a PennEngineering® Company



Heyco® -Tite Brass Liquid Tight Cordgrips

Straight-Thru, Pg Hubs

The Ultimate in Liquid Tight Strain Relief Protection

- Nickel plated brass construction for superior protection of flexible cables.
- Nickel-plated finish over brass provides excellent corrosion resistance and durability.
- IP 68 rated.
- For use in clearance or threaded holes.
- Long PG threads provide additional threads for easy locknut assembly.
- Multiple sizes for flexible cord diameters ranging from .138" (3,5 mm) to 1.378" (35,0 mm).
- We recommend using the smallest cordgrip that accommodates your cable size.
- Sealing gland is molded in Thermoplastic Polymer Elastomer (TPE) Material.
- **Locknuts not included.** For metal locknut specifications or to order locknuts separately, see page 3-48.
- DFARS Compliant

CABLE DIA. RANGE				PART NO.	THREAD SIZE	UL or UL	PART DIMENSIONS							
Minimum		Maximum					A Clearance Hole Dia.		B Max. O.A. Length		C Thread Length		D Wrenching Nut Flat Size	
in.	mm.	in.	mm.				in.	mm.	in.	mm.	in.	mm.	in.	mm.
Standard Thread														
.138	3,5	.197	5,0	4530	PG 7	cULUS	.492	12,5	1.063	27,0	.39	10,0	.59	15,0
.197	5,0	.256	6,5	4531										
.256	6,5	.315	8,0	4532										
.138	3,5	.177	4,5	4533	PG 9	cULUS	.598	15,2	1.18	30,0	.39	10,0	.71	18,0
.177	4,5	.236	6,0	4534										
.236	6,0	.315	8,0	4535										
.315	8,0	.413	10,5	4536	PG 9	cULUS	.598	15,2	1.26	32,0				
.157	4,0	.217	5,5	4537	PG 11	cULUS	.732	18,6	1.22	31,0	.39	10,0	.83	21,0
.217	5,5	.335	8,5	4538										
.335	8,5	.472	12,0	4539										
.236	6,0	.315	8,0	4540	PG 13.5	cULUS	.827	21,0	1.22	31,0	.39	10,0	.94	24,0
.315	8,0	.433	11,0	4541										
.433	11,0	.591	15,0	4542										
.236	6,0	.315	8,0	4543	PG 16	cULUS	.886	22,5	1.30	33,0	.39	10,0	.94	24,0
.315	8,0	.433	11,0	4544										
.433	11,0	.591	15,0	4545										
.374	9,5	.492	12,5	4546	PG 21	cULUS	1.114	28,3	1.57	40,0	.47	12,0	1.18	30,0
.492	12,5	.630	16,0	4547										
.630	16,0	.807	20,5	4548										
.630	16,0	.748	19,0	4549	PG 29	cULUS	1.469	37,3	1.57	40,0	.47	12,0	1.50	38,0
.748	19,0	.905	23,0	4550										
.906	23,0	1.083	27,5	4551										
.846	21,5	1.024	26,0	4552	PG 36	cULUS	1.874	47,6	1.85	47,0	.59	15,0	1.97	50,0
1.024	26,0	1.201	30,5	4553										
1.201	30,5	1.378	35,0	4554										

Short Thread													ALL NEW PRODUCTS		
.138	3,5	.197	5,0	14530	PG 7	cULUS	.492	12,5	.91	23,0	.24	6,0	.59	15,0	
.197	5,0	.256	6,5	14531											
.256	6,5	.315	8,0	14532											
.177	4,5	.236	6,0	14534	PG 9	cULUS	.598	15,2	1.02	26,0	.24	6,0	.71	18,0	
.236	6,0	.315	8,0	14535											
.315	8,0	.413	10,5	14536											
.157	4,0	.217	5,5	14537	PG 11	cULUS	.732	18,6	1.06	27,0	.24	6,0	.83	21,0	
.217	5,5	.335	8,5	14538											
.335	8,5	.472	12,0	14539											
.236	6,0	.315	8,0	14540	PG 13.5	cULUS	.803	20,4	1.06	27,0	.24	6,0	.94	24,0	
.315	8,0	.433	11,0	14541											
.433	11,0	.591	15,0	14542											
.236	6,0	.315	8,0	14543	PG 16	cULUS	.886	22,5	1.14	29,0	.24	6,0	.94	24,0	
.315	8,0	.433	11,0	14544											
.433	11,0	.591	15,0	14545											
.374	9,5	.492	12,5	14546	PG 21	cULUS	1.114	28,3	1.40	35,5	.30	7,5	1.18	30,0	
.492	12,5	.630	16,0	14547											
.630	16,0	.807	20,5	14548											
.748	19,0	.906	23,0	14550	PG 29	cULUS	1.469	37,3	1.42	36,0	.32	8,0	1.50	38,0	
.906	23,0	1.083	27,5	14551											
1.024	26,0	1.201	30,5	14553											
1.201	30,5	1.378	35,0	14554	PG 36	cULUS	1.874	47,6	1.85	47,0	.32	8,0	1.97	50,0	

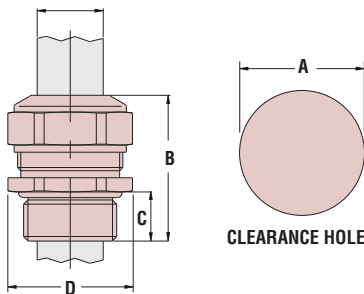

Quick Specs

Material	Nickel-Plated Brass w/TPE Sealing Gland
Certifications	cULUS Certified by UL for Compliance with both Canadian and U.S. requirements under File E51579.
	cULUS Recognized under the Component Program of Underwriters' Laboratories File E51579 to both Canadian and U.S. requirements.
Temperature Range	-40°F (-40°C) to 212°F (100°C)
IP Rating	IP 68, IP 69K

"Stay Connected" with



Liquid Tight Cordgrips

a PennEngineering® Company

Heyco® -Tite Brass Liquid Tight Cordgrips

Straight-Thru, Metric Hubs

The Ultimate in Liquid Tight Strain Relief Protection



CABLE DIA. RANGE				PART NO.	THREAD SIZE	UL or RA	PART DIMENSIONS							
Minimum		Maximum					A	B		C		D		
in.	mm.	in.	mm.				Clearance Hole Dia. in.	mm.	Max. O.A. Length in.	mm.	Thread Length in.	mm.	Wrenching Nut Flat Size in.	mm.

Standard Thread

.079	2,0	.098	2,5	4500	M6 x 1	cUL US	.236	6,0	.79	20,0	.32	8,0	.32	8,0
.098	2,5	.118	3,0	4501										
.118	3,0	.138	3,5	4502										
.098	2,5	.138	3,5	4503	M8 x 1,25	cUL US	.315	8,0	.94	24,0	.39	10,0	.43	11,0
.138	3,5	.197	5,0	4504										
.118	3,0	.157	4,0	4505	M10 x 1,5	cUL US	.394	10,0	.98	25,0	.39	10,0	.51	13,0
.157	4,0	.236	6,0	4506										
.138	3,5	.197	5,0	4507	M12 x 1,5	cUL US	.472	12,0	1.06	27,0	.39	10,0	.59	15,0
.197	5,0	.256	6,5	4508										
.256	6,5	.315	8,0	4509										
.138	3,5	.177	4,5	4510	M16 x 1,5	cUL US	.630	16,0	1.18	30,0	.39	10,0	.71	18,0
.177	4,5	.236	6,0	4511										
.236	6,0	.315	8,0	4512										
.315	8,0	.413	10,5	4513	M16 x 1,5	cUL US	.630	16,0	1.26	32,0				
.236	6,0	.315	8,0	4514	M20 x 1,5	cUL US	.787	20,0	1.22	31,0	.39	10,0	.94	24,0
.315	8,0	.433	11,0	4515										
.433	11,0	.591	15,0	4516	M20 x 1,5	cUL US	.787	20,0	1.30	33,0				
.374	9,5	.492	12,5	4517	M25 x 1,5	cUL US	.984	25,0	1.42	36,0				
.492	12,5	.630	16,0	4518	M25 x 1,5	cUL US	.984	25,0	1.50	38,0	.43	11,0	1.18	30,0
.630	16,0	.807	20,5	4519	M25 x 1,5	cUL US	.984	25,0	1.54	39,0				
.551	14,0	.669	17,0	4520	M32 x 1,5	cUL US	1.260	32,0	1.61	41,0	.51	13,0	1.42	36,0
.669	17,0	.827	21,0	4521										
.827	21,0	1.003	25,5	4522										
.787	20,0	.945	24,0	4523	M40 x 1,5	cUL US	1.574	40,0	1.73	44,0	.51	13,0	1.81	46,0
.945	24,0	1.122	28,5	4524										
1.122	28,5	1.299	33,0	4525										
1.142	29,0	1.299	33,0	4526	M50 x 1,5	cUL US	1.968	50,0	1.89	48,0	.55	14,0	2.17	55,0
1.299	33,0	1.457	37,0	4527										
1.457	37,0	1.654	42,0	4528										

Standard Thread, High Temperature*

.630	16,0	.807	20,5	4612	M25 x 1,5	cUL US	.984	25,0	1.54	39,0	.43	11,0	1.18	30,0
------	------	------	------	-------------	-----------	--------	------	------	------	------	-----	------	------	------

Short Thread

ALL NEW PRODUCTS

.079	2,0	.098	2,5	14500	M6 x 1	cUL US	.236	6,0	.67	17,0	.20	5,0	.32	8,0
.098	2,5	.118	3,0	14501										
.118	3,0	.138	3,5	14502										
.098	2,5	.138	3,5	14503	M8 x 1,25	cUL US	.315	8,0	.75	19,0	.20	5,0	.43	11,0
.138	3,5	.197	5,0	14504										
.118	3,0	.157	4,0	14505	M10 x 1,5	cUL US	.394	10,0	.79	20,0	.20	5,0	.51	13,0
.157	4,0	.236	6,0	14506										
.138	3,5	.197	5,0	14507	M12 x 1,5	cUL US	.472	12,0	.87	22,0	.20	5,0	.59	15,0
.197	5,0	.256	6,5	14508										
.256	6,5	.315	8,0	14509										
.138	3,5	.177	4,5	14510	M16 x 1,5	cUL US	.630	16,0	.98	25,0	.20	5,0	.71	18,0
.177	4,5	.236	6,0	14511										
.236	6,0	.315	8,0	14512										
.315	8,0	.413	10,5	14513	M16 x 1,5	cUL US	.630	16,0	1.06	27,0				
.236	6,0	.315	8,0	14514	M20 x 1,5	cUL US	.787	20,0	1.06	27,0	.24	6,0	.94	24,0
.315	8,0	.433	11,0	14515										
.433	11,0	.591	15,0	14516	M20 x 1,5	cUL US	.787	20,0	1.14	29,0				
.374	9,5	.492	12,5	14517	M25 x 1,5	cUL US	.984	25,0	1.26	32,0				
.492	12,5	.630	16,0	14518	M25 x 1,5	cUL US	.984	25,0	1.34	34,0	.28	7,0	1.18	30,0
.630	16,0	.807	20,5	14519	M25 x 1,5	cUL US	.984	25,0	1.38	35,0				
.551	14,0	.669	17,0	14520	M32 x 1,5	cUL US	1.260	32,0	1.42	36,0	.31	8,0	1.42	36,0
.669	17,0	.827	21,0	14521										
.827	21,0	1.003	25,5	14522										

Short Thread, High Temperature*

.315	8,0	.591	15,0	4699	M20 x 1,5	cUL US	.787	20,0	1.14	29,0	.24	6,0	.94	24,0
------	-----	------	------	-------------	-----------	--------	------	------	------	------	-----	-----	-----	------

* Special sealing gland rated to 200°C (392°F). Consult Heyco for other High Temperature rated sizes.

- Nickel plated brass construction for superior protection of flexible cables.
- Nickel-plated finish over brass provides excellent corrosion resistance and durability.
- IP 68 rated.
- For use in clearance or threaded holes.
- Meets the New European standard EN 50262 version A for metric cordgrips.
- Long metric threads provide additional threads for easy locknut assembly.
- Multiple sizes for flexible cord diameters ranging from .079" (2,0 mm) to 1.654" (42,0 mm).
- We recommend using the smallest cordgrip that accommodates your cable size.
- Sealing gland is molded in Thermoplastic Polymer Elastomer (TPE) Material.
- **Locknuts not included.** For metal locknut specifications or to order locknuts separately, see page 3-48.
- **See page 3-35 for Quick Specs.**
- DFARS Compliant

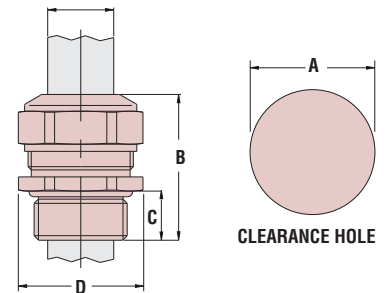

Quick Specs

“Stay Connected” with



Liquid Tight Cordgrips

a PennEngineering® Company



HEYbrid™ Brass/Nylon Liquid Tight Cordgrips

Straight-Thru, NPT Hubs

Don't get SKU'ed: More Cable Range, Fewer SKU's –

The Ultimate in Liquid Tight Strain Relief Protection



- **HEYCo-molded gripping finger/gland technology** accommodates the **widest cable range** over the **fewest sku's**.
- Rolled grease-free threads **prevent galling** and allow for multiple assemblies and disassemblies. No messy, unsightly thread lubrication required.
- Approved for **NEMA 4, 4X, 6 and 6P** applications.
- Self-retaining sealing rings eliminate the need for an O-Ring groove, thus **reducing cost**.
- Sealing washer required for through hole applications only.
- Typical applications: Control cabinets, car washes, hot tubs, instrumentation, carpet cleaning machines, underground for direct burial or submersed up to 130 ft. (70 PSIG).
- Constructed from corrosion resistant Nickel Plated Brass.
- Resistant to salt water, acids and most chemicals.
- Patent pending.
- DFARS Compliant

CABLE DIA. RANGE		PART NO.	DESCRIPTION	UL or RA	PART DIMENSIONS										
Minimum	Maximum				A	B		C		D					
in.	mm.	in.	mm.	Clearance Hole Dia.	in.	mm.	Max. O.A. Length	in.	mm.	Thread Length	in.	mm.	Wrenching Flat Size	in.	mm.

HEYCo-molded Finger/Gland

.065	1,7	.210	5,3	M5900	RNBCG 1/4 NPT	cULus	.540	13,7	1.29	32,8	.40	13,2	.75	19,1
.115	2,9	.250	6,4	M5901	NBCG 1/4 NPT	cULus	.680	17,3	1.39	35,3	.41	10,4	.88	22,4
.065	1,7	.230	5,8	M5902	RNBCG 3/8 NPT	cULus	.680	17,3	1.39	35,3	.41	10,4	.88	22,4
.105	2,7	.315	8,0	M5903	NBCG 3/8 NPT	cULus	.875	22,2	1.69	42,9	.53	13,5	1.06	26,9
.095	2,4	.290	7,4	M5906	RNBCG 1/2 NPT	cULus	.875	22,2	1.69	42,9	.53	13,5	1.06	26,9
.170	4,3	.450	11,4	M5907	NBCG 1/2 NPT	cULus	.875	22,2	1.81	46,0	.53	13,5	1.25	31,8
.180	4,6	.400	10,1	M5908	RNBCG LL 1/2 NPT	cULus	.875	22,2	1.81	46,0	.53	13,5	1.25	31,8
.260	6,6	.545	13,8	M5909	NBCG LL 1/2 NPT	cULus	1.109	28,2	1.93	49,0	.55	14,0	1.31	33,3
.250	6,4	.490	12,4	M5910	RNBCG 3/4 NPT	cULus	1.109	28,2	1.93	49,0	.55	14,0	1.31	33,3
.435	11,0	.705	17,9	M5911	NBCG 3/4 NPT	cULus	1.375	34,9	2.29	58,1	.69	17,5	1.75	44,5
.490	12,4	.785	19,9	M5912	RNBCG 1 NPT	cULus	1.375	34,9	2.29	58,1	.69	17,5	1.75	44,5
.590	15,0	1.000	25,4	M5913	NBCG 1 NPT	cULus								

The HEYCo-molded Finger, Gland & Seat

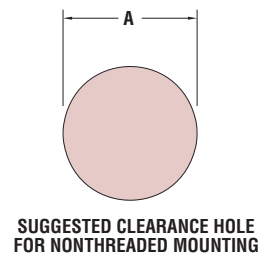
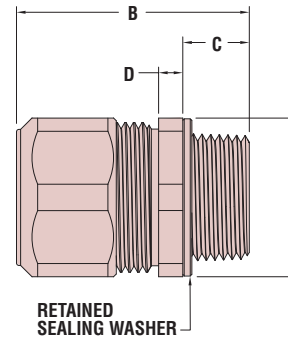
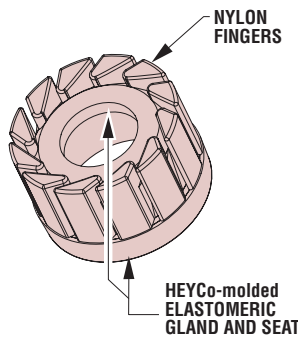

Quick Specs

Material	Nickel Plated Brass Body and sealing nut with nylon 6/6 and TPE co-molded finger/gland assembly SBR Sealing Washer
Certifications	cULus Certified by UL for Compliance with both Canadian and U.S. requirements under File E51579. cRAus Recognized under the Component Program of Underwriters' Laboratories File E51579 to both Canadian and U.S. requirements
Flammability Rating	94V-2
Temperature Range	-40°F (-40°C) to 221°F (105°C)
IP Rating	IP68 (70 PSI, 5 BAR)

"Stay Connected" with



Liquid Tight Cordgrips

a PennEngineering® Company



HEYbrid™ Brass/Nylon Liquid Tight Cordgrips

Straight-Thru, PG and Metric Hubs

The Ultimate in Liquid Tight Strain Relief Protection

CABLE DIA. RANGE				PART NO.	THREAD SIZE	PART DIMENSIONS							
Minimum		Maximum				A Clearance Hole Dia.		B Max. O.A. Length		C Thread Length		D Wrenching Nut Flat Size	
in.	mm.	in.	mm.			in.	mm.	in.	mm.	in.	mm.	in.	mm.

PG Hubs – Locknuts Not Included

.04	1,0	.20	5,0	4450	PG 7	.50	12,7	.87	22,0	.20	5,0	.59	15,0
.12	3,0	.28	7,0	4451									
.08	2,0	.24	6,0	4452	PG 9	.61	15,5	1.02	26,0	.24	6,0	.71	18,0
.18	4,5	.39	10,0	4453									
.14	3,5	.31	8,0	4454	PG 11	.75	19,0	1.22	31,0	.24	6,0	.87	22,0
.28	7,0	.51	13,0	4455									
.14	3,5	.31	8,0	4456	PG 13.5	.83	21,1	1.24	31,5	.26	6,5	.87	22,0
.28	7,0	.51	13,0	4457									
.14	3,5	.31	8,0	4458	PG 16	.91	23,1	1.24	31,5	.26	6,5	.94	24,0
.28	7,0	.51	13,0	4459									
.20	5,0	.43	11,0	4460	PG 16	.91	23,1	1.48	37,5	.26	6,5	1.10	28,0
.39	10,0	.67	17,0	4461									
.28	7,0	.59	15,0	4462	PG 21	1.14	29,0	1.57	40,0	.28	7,0	1.42	36,0
.51	13,0	.83	21,0	4463									
.59	15,0	.91	23,0	4464	PG 29	1.48	37,6	1.89	48,0	.31	8,0	1.81	46,0
.75	19,0	1.10	28,0	4465									

Metric Hubs – Locknuts Not Included

.04	1,0	.20	5,0	4472	M12 x 1,5	.50	12,5	1.14	29,0	.47	12,0	.59	15,0
.12	3,0	.28	7,0	4473									
.08	2,0	.24	6,0	4474	M16 x 1,5	.64	16,5	1.26	32,0	.47	12,0	.71	18,0
.18	4,5	.39	10,0	4475									
.14	3,5	.31	8,0	4476	M20 x 1,5	.80	20,5	1.46	37,0	.47	12,0	.87	22,0
.28	7,0	.51	13,0	4477									
.20	5,0	.43	11,0	4478	M25 x 1,5	1.00	25,4	1.69	43,0	.47	12,0	1.10	28,0
.39	10,0	.67	17,0	4479									
.28	7,0	.59	15,0	4480	M32 x 1,5	1.27	32,3	1.89	48,0	.59	15,0	1.42	36,0
.51	13,0	.83	21,0	4481									
.59	15,0	.91	23,0	4482	M40 x 1,5	1.59	40,5	2.17	55,0	.59	15,0	1.81	46,0
.75	19,0	1.10	28,0	4483									
.79	20,0	1.14	29,0	4484	M50 x 1,5	1.99	50,5	2.17	55,0	.59	15,0	2.17	55,0
.98	25,0	1.38	35,0	4485									
1.10	28,0	1.54	39,0	4486	M63 x 1,5	2.49	63,2	2.28	58,0	.59	15,0	2.76	70,0
1.38	35,0	1.89	48,0	4487									
1.73	44,0	2.17	55,0	4488	M63 x 1,5	2.49	63,2	2.28	58,0	.59	15,0	3.15	80,0

For PG Hub certifications, consult Heyco.

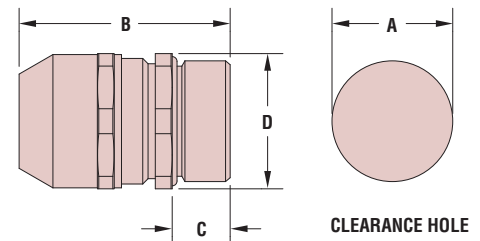
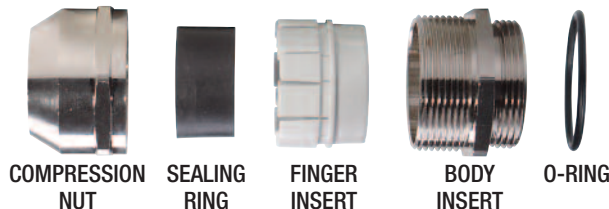

Material	Nickel-plated Brass w/polyamide PA 6 finger insert, TPE Sealing Gland and Buna-N O-ring
Certifications (Metric Hubs only)	Recognized under the Component Program of Underwriters' Laboratories File E51579 to both Canadian and U.S. requirements
	VDE Approved
Temperature Range	-40°F (-40°C) to 212°F (100°C)
IP Rating	IP 68, IP 69K

Quick Specs

- Provide the durability of a nickel-plated brass enclosure with **drastically lower installed cost** and more secure wire gripping with nylon finger design.
- HEYBrid Cordgrips make it possible to insert different diameters of cable in the same cable gland easily, flexibly and with a good seal.
- Movable articulated fingers provide large clamping and sealing areas for secure and flexible everyday use.
- When tightening the compression nut of the cordgrip, the segmented finger design compresses around the gland and wire to provide a torsion proof seal.
- Nickel-plated brass construction for superior protection of flexible cables.
- Nickel-plated finish over brass provides excellent corrosion resistance and durability.
- IP 68 rated.
- For use in clearance or threaded holes.
- Multiple sizes for flexible cord diameters ranging from .04" (1,0 mm) to 2.17" (55,0 mm).
- We recommend using the smallest cordgrip that accommodates your cable size.
- Sealing gland is molded in Thermoplastic Polymer Elastomer (TPE) material.
- **Locknuts not included.** For metal locknut specifications or to order locknuts separately, see page 3-48.
- DFARS Compliant

“Stay Connected” with



Liquid Tight Cordgrips

a PennEngineering® Company



Heyco®-Tite EMC Brass Liquid Tight Cordgrips

Straight Thru, PG Hubs

EMC Nickel-Plated Brass with Contact Sleeve

The Ultimate in Liquid Tight Strain Relief Protection

- Ideal for applications where Electromagnetic Interference (EMI) protection or Electromagnetic Compatibility (EMC) is needed.
- IP 68 rated.
- Nickel-plated finish over brass provides excellent corrosion resistance and durability.
- Excellent 360° shield contact with contact sleeve due to braided shield which runs into the gland.
- Combination of the sealing insert and the contact socket guarantees a constant contact quality with minimal transfer impedance.
- Inner cable protection.
- Long thread for use in standard or thick panels.
- Multiple sizes for flexible cord diameters ranging from .177" (4,5 mm) to 1.003" (25,5 mm).
- For use in clearance or threaded holes.
- Cordgrips are made of nickel plated brass and the gland is made of TPE.
- EMC locknuts available. See page 3-41.
- DFARS Compliant

CABLE DIA. RANGE				PART NO.	THREAD SIZE	UL or IEC	PART DIMENSIONS							
Minimum		Maximum					A Clearance Hole Dia.		B Max. O.A. Length		C Thread Length		D Wrenching Nut Flat Size	
in.	mm.	in.	mm.			in.	mm.	in.	mm.	in.	mm.	in.	mm.	
Standard Thread														
.177	4,5	.236	6,0	4600	PG7	cULus	.492	12,5	1.06	27,0	.39	10,0	.59	15,0
.236	6,0	.295	7,5	4641	PG9	cULus	.598	15,2	1.18	30,0	.39	10,0	.71	18,0
.315	8,0	.394	10,0	4645	PG9	cULus	.598	15,2	1.26	32,0	.39	10,0	.71	18,0
.217	5,5	.335	8,5	4647	PG11	cULus	.732	18,6	1.22	31,0	.39	10,0	.83	21,0
.335	8,5	.472	12,0	4648	PG11	cULus	.732	18,6	1.22	31,0	.39	10,0	.83	21,0
.315	8,0	.433	11,0	4650	PG13.5	cULus	.803	20,4	1.22	31,0	.39	10,0	.94	24,0
.433	11,0	.551	14,0	4651	PG13.5	cULus	.803	20,4	1.30	33,0	.39	10,0	.94	24,0
.315	8,0	.433	11,0	4653	PG16	cULus	.886	22,5	1.22	31,0	.39	10,0	.94	24,0
.433	11,0	.551	14,0	4654	PG16	cULus	.886	22,5	1.30	33,0	.39	10,0	.94	24,0
.512	13,0	.630	16,0	4656	PG21	cULus	1.114	28,3	1.45	37,0	.47	12,0	1.18	30,0
.630	16,0	.748	19,0	4657	PG21	cULus	1.114	28,3	1.57	40,0	.47	12,0	1.18	30,0
.748	19,0	.906	23,0	4659	PG29	cULus	1.469	37,3	1.61	41,0	.47	12,0	1.50	38,0
.906	23,0	1.003	25,5	4660	PG29	cULus	1.469	37,3	1.61	41,0	.47	12,0	1.50	38,0
Short Thread														
ALL NEW PRODUCTS														
.177	4,5	.236	6,0	14640	PG 7	cULus	.492	12,5	.91	23,0	.24	6,0	.59	15,0
.236	6,0	.295	7,5	14641	PG 7	cULus	.492	12,5	.91	23,0	.24	6,0	.59	15,0
.236	6,0	.315	8,0	14644	PG 9	cULus	.598	15,2	1.02	26,0	.24	6,0	.71	18,0
.315	8,0	.394	10,0	14645	PG 9	cULus	.598	15,2	1.10	28,0	.24	6,0	.71	18,0
.217	5,5	.335	8,5	14647	PG 11	cULus	.732	18,6	1.06	27,0	.24	6,0	.83	21,0
.335	8,5	.472	12,0	14648	PG 11	cULus	.732	18,6	1.06	27,0	.24	6,0	.83	21,0
.315	8,0	.433	11,0	14650	PG 13.5	cULus	.803	20,4	1.06	27,0	.24	6,0	.94	24,0
.433	11,0	.551	14,0	14651	PG 13.5	cULus	.803	20,4	1.14	29,0	.24	6,0	.94	24,0
.315	8,0	.433	11,0	14653	PG 16	cULus	.886	22,5	1.06	27,0	.24	6,0	.94	24,0
.433	11,0	.551	14,0	14654	PG 16	cULus	.886	22,5	1.14	29,0	.24	6,0	.94	24,0
.512	13,0	.630	16,0	14656	PG 21	cULus	1.114	28,3	1.28	32,5	.30	7,5	1.18	30,0
.630	16,0	.748	19,0	14657	PG 21	cULus	1.114	28,3	1.40	35,5	.30	7,5	1.18	30,0
.748	19,0	.906	23,0	14659	PG 29	cULus	1.469	37,3	1.47	37,0	.31	8,0	1.50	38,0
.906	23,0	1.003	25,5	14660	PG 29	cULus	1.469	37,3	1.47	37,0	.31	8,0	1.50	38,0

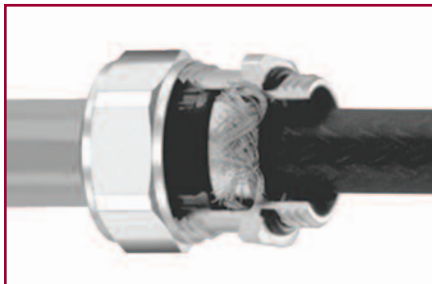

Quick Specs

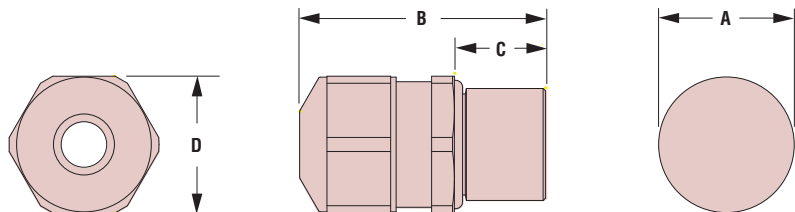

Material	Nickel-Plated Brass W/TPE Sealing Gland
Certifications	cULus Recognized under the Component Program of Underwriters' Laboratories File E51579 to both Canadian and U.S. requirements
Temperature Range	-40°F (-40°C) to 212°F (100°C)
IP Rating	IP 68, IP 69K

“Stay Connected” with



Liquid Tight Cordgrips

a PennEngineering® Company

Heyco®-Tite EMC Brass Liquid Tight Cordgrips

Straight-Thru, Metric Hubs

EMC Nickel-Plated Brass with Contact Sleeve

The Ultimate in Liquid Tight Strain Relief Protection



CABLE DIA. RANGE				PART NO.	THREAD SIZE	UL or IEC	PART DIMENSIONS							
Minimum		Maximum					A Clearance Hole Dia.		B Max. O.A. Length		C Thread Length		D Wrenching Nut Flat Size	
in.	mm.	in.	mm.				in.	mm.	in.	mm.	in.	mm.	in.	mm.
Standard Thread														
.098	2,5	.138	3,5	4613	M8 x 1,25	cRU _{US}	.315	8,0	.94	24,0	.39	10,0	.43	11,0
.118	3,0	.157	4,0	4614										
.118	3,0	.157	4,0	4615	M10 x 1,5	cRU _{US}	.394	10,0	.98	25,0	.39	10,0	.51	13,0
.157	4,0	.236	6,0	4616										
.177	4,5	.236	6,0	4618	M12 x 1,5	cRU _{US}	.472	12,0	1.06	27,0	.39	10,0	.59	15,0
.236	6,0	.295	7,5	4619										
.236	6,0	.312	8,0	4622	M16 x 1,5	cRU _{US}	.630	16,0	1.18	30,0	.39	10,0	.71	18,0
.315	8,0	.394	10,0	4623	M16 x 1,5			.630	16,0	1.26				
.315	8,0	.433	11,0	4625	M20 x 1,5	cRU _{US}	.787	20,0	1.22	31,0	.39	10,0	.94	24,0
.433	11,0	.551	14,0	4626	M20 x 1,5			.787	20,0	1.30				
.512	13,0	.630	16,0	4628	M25 x 1,5	cRU _{US}	.984	25,0	1.41	36,0	.43	11,0	1.18	30,0
.630	16,0	.748	19,0	4629	M25 x 1,5			.984	25,0	1.53				
.709	18,0	.827	21,0	4631	M32 x 1,5	cRU _{US}	1.260	32,0	1.65	42,0	.51	13,0	1.42	36,0
.827	21,0	.984	25,0	4632										
Short Thread												ALL NEW PRODUCTS		
.098	2,5	.138	3,5	14613	M8 x 1,25	cRU _{US}	.315	8,0	.75	19,0	.20	5,0	.43	11,0
.118	3,0	.157	4,0	14614										
.118	3,0	.157	4,0	14615	M10 x 1,5	cRU _{US}	.394	10,0	.79	20,0	.20	5,0	.51	13,0
.157	4,0	.236	6,0	14616										
.177	4,5	.236	6,0	14618	M12 x 1,5	cRU _{US}	.472	12,0	.87	22,0	.20	5,0	.59	15,0
.236	6,0	.295	7,5	14619										
.236	6,0	.312	8,0	14622	M16 x 1,5	cRU _{US}	.630	16,0	.98	25,0	.20	5,0	.71	18,0
.315	8,0	.394	10,0	14623	M16 x 1,5			.630	16,0	1.06				
.315	8,0	.433	11,0	14625	M20 x 1,5	cRU _{US}	.787	20,0	1.06	27,0	.24	6,0	.94	24,0
.433	11,0	.551	14,0	14626	M20 x 1,5			.787	20,0	1.10				
.512	13,0	.630	16,0	14628	M25 x 1,5	cRU _{US}	.984	25,0	1.26	32,0	.28	7,0	1.18	30,0
.630	16,0	.748	19,0	14629	M25 x 1,5			.984	25,0	1.38				
.709	18,0	.827	21,0	14631	M32 x 1,5	cRU _{US}	1.260	32,0	1.46	37,0	.31	8,0	1.42	36,0
.827	21,0	.984	25,0	14632										
Short Thread, High Temperature*														
.236	6,0	.315	8,0	4609	M16 x 1,5	cRU _{US}	.630	16,0	.98	25,0	.20	5,0	.71	18,0

*Special sealing gland rated to 200°C (392°F).

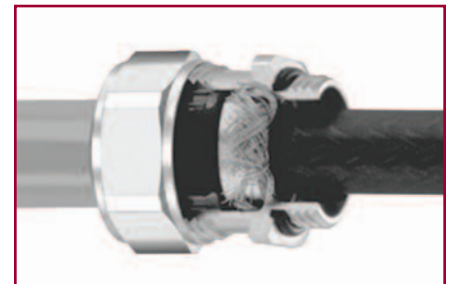
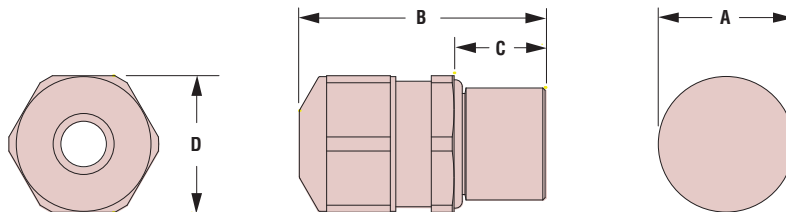

Quick Specs

Material	Nickel-Plated Brass W/TPE Sealing Gland
Certifications	cRU _{US} Recognized under the Component Program of Underwriters' Laboratories File E51579 to both Canadian and U.S. requirements
Temperature Range	-40°F (-40°C) to 212°F (100°C)
IP Rating	IP 68, IP 69K

“Stay Connected” with



Liquid Tight Cordgrips

a PennEngineering® Company



Heyco®-Tite EMC-2 Brass Liquid Tight Cordgrips

Straight-Thru, Metric Hubs

EMC Nickel-Plated Brass with Contact Sleeve

The Ultimate in Liquid Tight Strain Relief Protection

- Ideal for applications where **Electromagnetic Interference (EMI) protection or Electromagnetic Compatibility (EMC) is needed.**
- **Innovative contact spring**, due to strong clamping, virtually guarantees a secure shielded tap connection.
- Contact spring can be precisely positioned due to its clearly defined limit stop, making installation simple.
- Clamping technique ensures the cable can be rotated, pushed and easily dismantled during mounting.
- Excellent 360° shield contact with contact sleeve due to braided shield which runs into the gland.
- Combination of the sealing insert and the contact socket guarantees a constant contact quality with minimal transfer impedance.
- For use in clearance or threaded holes.
- DFARS Compliant

CABLE DIA. RANGE				PART NO.	THREAD SIZE	UL or IEC	PART DIMENSIONS							
Minimum		Maximum					A Clearance Hole Dia.		B Max. O.A. Length		C Thread Length		D Wrenching Nut Flat Size	
in.	mm.	in.	mm.				in.	mm.	in.	mm.	in.	mm.	in.	mm.

Standard Thread

.138	3,5	.197	5,0	4594	M12 x 1,5	cULus	.472	12,0	1.26	32,0	.39	10,0	.59	15,0
.197	5,0	.256	6,5	4595										
.236	6,0	.413	10,5	4596	M16 x 1,5	cULus	.643	16,0	1.38	35,0	.39	10,0	.71	18,0
.315	8,0	.591	15,0	4597	M20 x 1,5	cULus	.787	20,0	1.46	37,0	.39	10,0	.94	24,0
.492	12,5	.807	20,5	4598	M25 x 1,5	cULus	.984	25,0	1.73	44,0	.43	11,0	1.18	30,0
.669	17,0	1.004	25,4	4599	M32 x 1,5	cULus	1.260	32,0	1.81	46,0	.51	13,0	1.42	36,0

Short Thread

.138	3,5	.197	5,0	14594	M12 x 1,5	cULus	.472	12,0	1.06	27,0	.20	5,0	.59	15,0
.197	5,0	.256	6,5	14595										
.236	6,0	.413	10,5	14596	M16 x 1,5	cULus	.630	16,0	1.18	30,0	.20	5,0	.71	18,0
.315	8,0	.591	15,0	14597	M20 x 1,5	cULus	.787	20,0	1.30	33,0	.24	6,0	.94	24,0
.492	12,5	.807	20,5	14598	M25 x 1,5	cULus	.984	25,0	1.57	40,0	.28	7,0	1.18	30,0
.669	17,0	1.004	25,5	14599	M32 x 1,5	cULus	1.260	32,0	1.61	41,0	.31	8,0	1.42	36,0

ALL NEW PRODUCTS

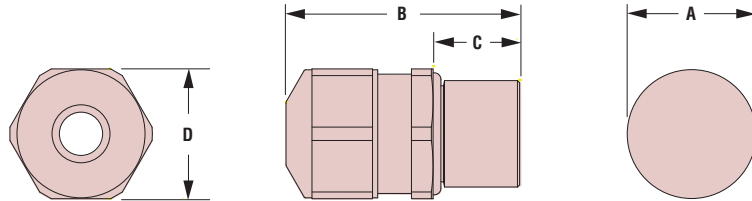

Heyco®-Tite EMC Brass Locknuts

EMC Nickel-Plated Brass

- Ideal for use with painted surfaces to ensure **EMC/EMI integrity.**
- Cutting teeth on locknuts provide optimal shield contact with painted surfaces.
- Nickel-plated finish over brass provides excellent corrosion resistance and durability.
- DFARS Compliant

THREAD SIZE A	PART NO.	DESCRIPTION	PART DIMENSIONS			
			B Thickness		C Wrenching Flat Size	
			in.	mm.	in.	mm.

PG Thread

PG 7	4671	EMC LN PG 7	.13	3,3	.59	15,0
PG 9	4672	EMC LN PG 9	.13	3,3	.71	18,0
PG 11	4673	EMC LN PG 11	.14	3,5	.83	21,0
PG 13.5	4674	EMC LN PG 13.5	.14	3,5	.94	24,0
PG 16	4675	EMC LN PG 16	.14	3,5	1.02	26,0
PG 21	4676	EMC LN PG 21	.16	4,0	1.26	32,0
PG 29	4677	EMC LN PG 29	.18	4,6	1.61	41,0

Metric Thread

M8 x 1,25	4681	EMC LN M8	.13	3,3	.43	11,0
M10 x 1,5	4682	EMC LN M10	.13	3,3	.51	13,0
M12 x 1,5	4683	EMC LN M12	.14	3,5	.59	15,0
M16 x 1,5	4684	EMC LN M16	.14	3,5	.75	19,0
M20 x 1,5	4685	EMC LN M20	.16	4,0	.94	24,0
M25 x 1,5	4686	EMC LN M25	.16	4,0	1.18	30,0
M32 x 1,5	4687	EMC LN M32	.20	5,0	1.42	36,0

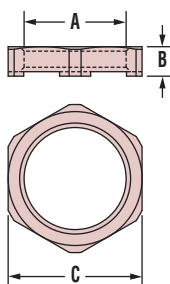

Material	Nickel-Plated Brass W/TPE Sealing Gland
Certifications	cULus Recognized under the Component Program of Underwriters' Laboratories File E51579 to both Canadian and U.S. requirements
Temperature Range	-40°F (-40°C) to 212°F (100°C)
IP Rating	IP 68, IP 69K

“Stay Connected” with



Liquid Tight Cordgrips

a PennEngineering® Company

Heyco® -Tite Brass Lazy Bend Liquid Tight Cordgrips

Metric Hubs

The Ultimate in Liquid Tight Strain Relief Protection



CABLE DIAMETER RANGE				PART NO.	THREAD SIZE	PART DIMENSIONS									
Minimum		Maximum				A Clearance Hole Dia.		B Max. O.A. Length		C Thread Length		D Wrenching Flat Size		E Lazy Bend Nozzle Lg	
in.	mm.	in.	mm.			in.	mm.	in.	mm.	in.	mm.	in.	mm.	in.	mm.

EPDM Nozzle

.150	3,8	.189	4,8	14670	M8 x 1.25	.315	8,0	1.69	43,0	.24	6,0	.43	11,0	.98	25,0
.157	4,0	.236	6,0	14671	M10 x 1.5	.394	10,0	2.40	61,0	.24	6,0	.63	16,0	1.38	35,0
.157	4,0	.236	6,0	14672	M12 x 1.5	.472	12,0								
.236	6,0	.346	8,8	14673	M16 x 1.5	.630	16,0	2.95	75,0	.24	6,0	.79	20,0	1.77	45,0
.354	9,0	.433	11,0	14674	M20 x 1.5	.787	20,0	3.90	99,0	.24	6,0	.94	24,0	2.56	65,0
.413	10,5	.512	13,0	14675	M20 x 1.5	.787	20,0	4.29	109,0	.24	6,0	.94	24,0	2.87	73,0
.512	13,0	.650	16,5	14676	M25 x 1.5	.984	25,0	5.20	132,0	.28	7,0	1.26	32,0	3.62	92,0

Stainless Steel Nozzle

ALL NEW PRODUCTS

.098	2,5	.118	3,0	14700	M8 x 1.25	.315	8,0	2.13	54,0	.20	5,0	.43	11,0	1.93	49,0
.138	3,5	.157	4,0	14701											
.118	3,0	.157	4,0	14702	M10 x 1.5	.394	10,0	2.24	57,0	.20	5,0	.51	13,0	2.05	52,0
.157	4,0	.236	6,0	14703											
.138	3,5	.197	5,0	14704											
.197	5,0	.256	6,5	14705	M12 x 1.5	.472	12,0	2.44	62,0	.20	5,0	.59	15,0	2.24	57,0
.256	6,5	.295	7,5	14706											
.177	4,5	.236	6,0	14707											
.236	6,0	.315	8,0	14708	M16 x 1.5	.630	16,0	2.80	71,0	.20	5,0	.71	18,0	2.60	66,0
.315	8,0	.413	10,5	14709											
.236	6,0	.315	8,0	14710											
.315	8,0	.433	11,0	14711	M20 x 1.5	.787	20,0	3.62	92,0	.24	6,0	.94	24,0	3.39	86,0
.433	11,0	.571	14,5	14712											
.374	9,5	.492	12,5	14713											
.492	12,5	.630	16,0	14714	M25 x 1.5	.984	25,0	4.17	106,0	.28	7,0	1.18	30,0	3.90	99,0
.630	16,0	.748	19,0	14715											
.669	17,0	.827	21,0	14716	M32 x 1.5	1.260	32,0	4.61	117,0	.31	8,0	1.42	36,0	4.29	109,0
.827	21,0	.965	24,5	14717											

- EPDM and Stainless Steel Nozzles ease the cable into a lazy bend; prevents sharp bending and ensure longest cable and product life.
- Nickel-plated brass construction for superior protection of flexible cables.
- Nickel-plated finish over brass provides excellent corrosion resistance and durability.
- Adds reliability, longevity, and safety to your application.
- Protects the lifeline of your electric/electronic products by absorbing the forces of pull, push, twist, and flex.
- Securely anchors, insulates, and protects cables at panel entry points.
- DFARS Compliant

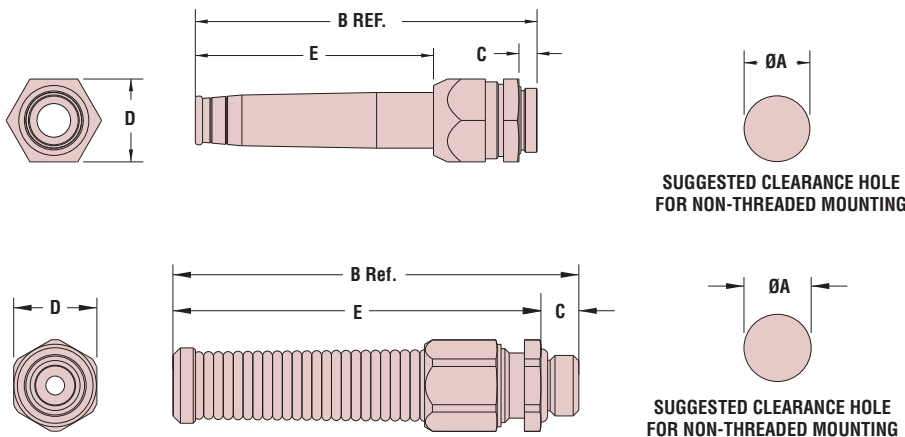

	EPDM Nozzle	Stainless Steel Nozzle
Material	Nickel-Plated Brass with NBR Sealing Gland and O-Ring and EPDM Nozzle	Nickel-Plated Brass with Stainless Steel Nozzle w/TPE Sealing Gland and NBR O-Ring
Temperature Range	-40°F (-40°C) to 212°F (100°C)	
IP Rating	IP 68, IP 69K	

“Stay Connected” with



Liquid Tight Cordgrips

a PennEngineering® Company



Heyco® -Tite Brass Profile™ Liquid Tight Cordgrips

Metric Hubs

The Ultimate in Liquid Tight Strain Relief Protection

- Heyco Profile Liquid Tight Cordgrips inhibit manipulation from outside the panel - there is no contact surface offering opportunity for interference by hand or tool.
- Attractive low profile shape for design-sensitive applications.
- Nickel-plated brass construction for superior protection of flexible cables.
- Nickel-plated finish over brass provides excellent corrosion resistance and durability.
- DFARS Compliant

CABLE DIAMETER RANGE				PART NO.	THREAD SIZE	PART DIMENSIONS							
Minimum		Maximum				A Clearance Hole Dia.		B Head Height		C Length Below Panel		D Wrenching Flat Size	
in.	mm.	in.	mm.			in.	mm.	in.	mm.	in.	mm.	in.	mm.

Standard Gland

.197	5,0	.256	6,5	14800	M16 x 1,5	.866	22,0	.16	4,0	.83	21,0	.71	18,0
.256	6,5	.315	8,0	14801									
.236	6,0	.315	8,0	14802	M20 x 1,5	1.063	27,0	.18	4,5	.91	23,0	.85	24,0
.315	8,0	.413	10,5	14803									
.315	8,0	.433	11,0	14804	M25 x 1,5	1.260	32,0	.22	5,5	.98	25,0	1.18	30,0
.433	11,0	.591	15,0	14805									
.492	12,5	.630	16,0	14806	M32 x 1,5	1.535	39,0	.24	6,0	1.10	28,0	1.42	36,0
.630	16,0	.806	20,5	14807									

High Temperature Gland *

.197	5,0	.256	6,5	14810	M16 x 1,5	.866	22,0	.16	4,0	.83	21,0	.71	18,0
.256	6,5	.315	8,0	14811									
.236	6,0	.315	8,0	14812	M20 x 1,5	1.063	27,0	.18	4,5	.91	23,0	.85	24,0
.315	8,0	.413	10,5	14813									
.315	8,0	.433	11,0	14814	M25 x 1,5	1.260	32,0	.22	5,5	.98	25,0	1.18	30,0
.433	11,0	.591	15,0	14815									
.492	12,5	.630	16,0	14816	M32 x 1,5	1.535	39,0	.24	6,0	1.10	28,0	1.42	36,0
.630	16,0	.806	20,5	14817									

FDA Approved Gland *

.197	5,0	.256	6,5	14820	M16 x 1,5	.866	22,0	.16	4,0	.83	21,0	.71	18,0
.256	6,5	.315	8,0	14821									
.236	6,0	.315	8,0	14822	M20 x 1,5	1.063	27,0	.18	4,5	.91	23,0	.85	24,0
.315	8,0	.413	10,5	14823									
.315	8,0	.433	11,0	14824	M25 x 1,5	1.260	32,0	.22	5,5	.98	25,0	1.18	30,0
.433	11,0	.591	15,0	14825									
.492	12,5	.630	16,0	14826	M32 x 1,5	1.535	39,0	.24	6,0	1.10	28,0	1.42	36,0
.630	16,0	.806	20,5	14827									

*Extra lead time required, consult Heyco

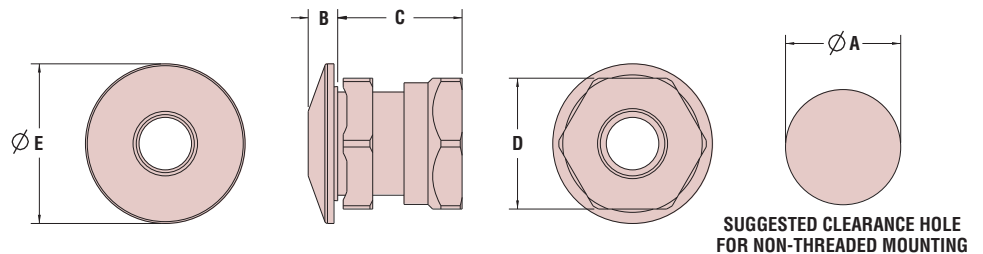
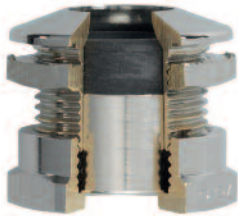

Quick Specs

Material: Nickel-Plated Brass w/TPE Sealing Gland and FPM Sealing Washer
 Temperature Range: -40°F (-40°C) to 212°F (100°C)
 IP Rating: IP 68, IP 69K

“Stay Connected” with



Liquid Tight Cordgrips

a PennEngineering® Company



Heyco® -Tite Brass Liquid Tight Cordgrips

Metric Hubs

Explosion Proof for Hazardous Locations

The Ultimate in Liquid Tight Strain Relief Protection

CABLE DIAMETER RANGE				PART NO.	THREAD SIZE	PART DIMENSIONS							
Minimum		Maximum				A Clearance Hole Dia.		B Max. O.A. Length		C Thread Length		D Wrenching Flat Size	
in.	mm.	in.	mm.			in.	mm.	in.	mm.	in.	mm.	in.	mm.
.118	3,0	.276	7,0	14830	M16 x 1,5	.630	16,0	1.50	38,0	.47	12,0	.83	21,0
.197	5,0	.394	10,0	14831		.630	16,0	1.50	38,0	.47	12,0	.94	24,0
.197	5,0	.433	11,0	14832	M20 x 1,5	.787	20,0	1.50	38,0	.47	12,0	.94	24,0
.354	9,0	.551	14,0	14833		.787	20,0	1.50	38,0	.47	12,0	1.18	30,0
.295	7,5	.591	15,0	14834	M25 x 1,5	.984	25,0	1.57	40,0	.47	12,0	1.26	32,0
.492	12,5	.709	18,0	14835		.984	25,0	1.57	40,0	.47	12,0	1.26	32,0
.669	17,0	.906	23,0	14836	M32 x 1,5	1.260	32,0	1.77	45,0	.47	12,0	1.61	41,0
.827	21,0	1.024	26,0	14837		1.260	32,0	1.77	45,0	.47	12,0	1.61	41,0
.827	21,0	1.024	26,0	14838	M40 x 1,5	1.575	40,0	1.85	47,0	.55	14,0	1.61	41,0
.945	24,0	1.260	32,0	14839		1.575	40,0	1.89	48,0	.55	14,0	1.97	50,0
1.102	28,0	1.417	36,0	14840	M50 x 1,5	1.968	50,0	1.89	48,0	.55	14,0	2.17	55,0
1.378	35,0	1.654	42,0	14841		1.968	50,0	1.93	49,0	.55	14,0	2.36	60,0
1.417	36,0	1.732	44,0	14842	M63 x 1,5	2.480	63,0	1.93	49,0	.55	14,0	2.56	65,0
1.693	43,0	1.968	50,0	14843		2.480	63,0	1.93	49,0	.55	14,0	2.76	70,0

- Suitable for flameproof enclosures Ex d 11C and increased safety Ex e 11
- Certificate: EC-type examination certificate PTB 10 ATEX 1034X
- Certificate: IECEx Certificate: IECEx PTB 12.0055x
- Certified for category 2G: II 2G Ex db eb IIC
- Certified for category 2D: II 2D Ex ta IIIC
- Zone: Gas 1 and 2/dust 21 and 22

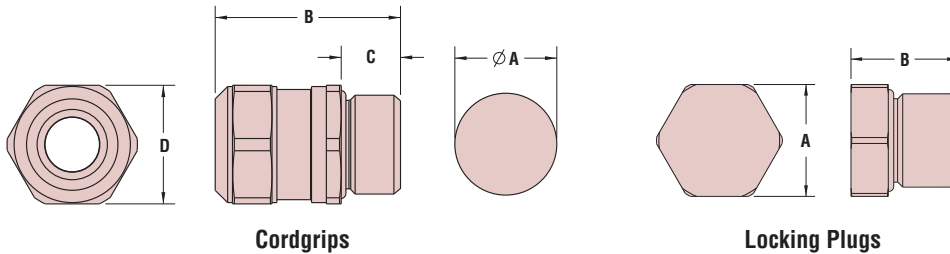

Heyco® -Tite Brass Locking Plugs

Metric Hubs

THREAD TYPE / SIZE	PART NO.	DESCRIPTION	PART DIMENSIONS			
			A Wrenching Flats		B Overall Length	
			in.	mm.	in.	mm.
M12 x 1,5	14691	BRASS TPX M12	.59	15,0	.79	20,0
M16 x 1,5	14692	BRASS TPX M16	.71	18,0	.83	21,0
M20 x 1,5	14693	BRASS TPX M20	.94	24,0	.91	23,0
M25 x 1,5	14694	BRASS TPX M25	1.18	30,0	.98	25,0
M32 x 1,5	14695	BRASS TPX M32	1.42	36,0	1.06	27,0
M40 x 1,5	14696	BRASS TPX M40	1.81	46,0		
M50 x 1,5	14697	BRASS TPX M50	2.17	55,0		
M63 x 1,5	14698	BRASS TPX M63	2.76	70,0		

- Suitable for flameproof enclosures Ex d IIC
- IECEx Certificate: 1ECEx PTB 12.0056
- Certified for category 2G: II 2G Ex db eb IIC
- Certified for category 2D: II 2D Ex ta IIIC
- Zone: Gas 1 and 2/dust 21 and 22



	Cordgrips	Locking Plugs
Material	Nickel-Plated Brass Body w/NBR Seal	Nickel-Plated Brass Body w/FPM O-Ring
Temperature Range	-76°F (-60°C) to 221°F (105°C)	-40°F (-40°C) to 212°F (100°C)
IP Rating	IP 68, IP 69K	IP 69K

Quick Specs

“Stay Connected” with



Liquid Tight Cordgrips

a PennEngineering® Company

ALL NEW PRODUCTS!



Heyco® -Tite Brass Liquid Tight Clamping Cordgrips

Metric Hubs

The Ultimate in Liquid Tight Strain Relief Protection

- Extra pull-out resistance for applications requiring maximum strain relief in addition to liquid tight sealing.
- IP 68 and IP 69 rated.
- For non-liquid tight Heyco Brass Clamping Strain Reliefs, see page 4-35.
- Available by special order only.
- Locknuts not included. For metal locknut specifications or to order locknuts separately, see page 3-48.

CABLE DIA. RANGE				PART NO.	THREAD SIZE	SEALING INSERT PIECES	PART DIMENSIONS							
Minimum		Maximum					A Clearance Hole Dia.		B Max. O.A. Length		C Thread Length		D Wrenching Flat Size	
in.	mm.	in.	mm.				in.	mm.	in.	mm.	in.	mm.	in.	mm.

Standard Threads

.118	3,0	.157	4,0	14850	M10 x 1,5	1	.394	10,0	1.34	34,0	.39	10,0	.51/.63	13/16
.157	4,0	.236	6,0	14851										
.197	5,0	.256	6,5	14852	M12 x 1,5	1	.472	12,0	1.42	36,0	.39	10,0	.59/.63	15/16
.256	6,5	.315	8,0	14853										
.236	6,0	.413	10,5	14854	M16 x 1,5	2	.630	16,0	1.57	40,0	.39	10,0	.71/.75	18/19
.315	8,0	.591	15,0	14855										
.492	12,5	.807	20,5	14856	M25 x 1,5	2	.984	25,0	1.81	46,0	.43	11,0	1.18	30
.669	17,0	1.004	25,5	14857										
.945	24,0	1.299	33,0	14858	M40 x 1,5	2	1.575	40,0	2.24	57,0	.51	13,0	1.81	46
1.299	33,0	1.654	42,0	14859										
1.575	40,0	2.047	52,0	14860	M63 x 1,5	2	2.480	63,0	2.72	69,0	.55	14,0	2.76	70
1.968	50,0	2.480	63,0	14861										

Short Threads

.118	3,0	.157	4,0	14862	M10 x 1,5	1	.394	10,0	1.14	29,0	.20	5,0	.51/.63	13/16
.157	4,0	.236	6,0	14863										
.197	5,0	.256	6,5	14864	M12 x 1,5	1	.472	12,0	1.22	31,0	.20	5,0	.59/.63	15/16
.256	6,5	.315	8,0	14865										
.236	6,0	.413	10,5	14866	M16 x 1,5	2	.630	16,0	1.38	35,0	.20	5,0	.71/.75	18/19
.315	8,0	.591	15,0	14867										
.492	12,5	.807	20,5	14868	M25 x 1,5	2	.984	25,0	1.65	42,0	.28	7,0	1.18	30
.669	17,0	1.004	25,5	14869										
.945	24,0	1.299	33,0	14870	M40 x 1,5	2	1.575	40,0	2.05	52,0	.31	8,0	1.81	46
1.299	33,0	1.654	42,0	14871										
1.575	40,0	2.047	52,0	14872	M63 x 1,5	2	2.480	63,0	2.56	65,0	.39	10,0	2.76	70
1.968	50,0	2.480	63,0	14873										

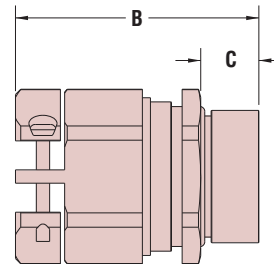
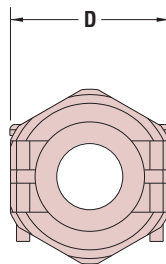

Quick Specs

Material
Certifications
Temperature Range
IP Rating



Nickel-Plated Brass Body w/TPE Seal, NBR O-ring and Stainless Steel Screws
Marks License #40019686
-40°F (-40°C) to 212°F (100°C)
IP 68, IP 69K

“Stay Connected” with



Liquid Tight Cordgrips

a PennEngineering® Company



Heyco® Retaining Sealing Washers

Will Fit These Electrical Fitting Threaded Hubs	PART NO. Black	DESCRIPTION	PART DIMENSIONS					
			A Inside Diameter		B Outside Diameter		C Thickness	
			in.	mm.	in.	mm.	in.	mm.
NPT Hubs								
1/4	G6000	RSW 1/4 NPT	.540	13,7	.740	18,8	.076	1,9
3/8	G6001	RSW 3/8 NPT	.680	17,3	.865	22,0		
1/2	G6002	RSW 1/2 NPT	.875	22,2	1.050	26,7		
3/4	G6003	RSW 3/4 NPT	1.109	28,2	1.300	33,0		
1	G6004	RSW 1 NPT	1.375	34,9	1.725	43,8		
NEW! 1-1/4	G6005	RSW 1-1/4 NPT	1.735	44,1	2.094	53,2		
NEW! 1-1/2	G6006	RSW 1-1/2 NPT	1.984	50,4	2.375	60,3		
NEW! 2	G6007	RSW 2 NPT	2.469	62,7	2.740	69,6		
Pg Hubs								
Pg 7	G6010	RSW PG 7	.495	12,6	.740	18,8	.076	1,9
Pg 9	G6011	RSW PG 9	.600	15,2	.865	22,0		
Pg 13	G6013	RSW PG 13.5	.810	20,6	1.050	26,7		
Pg 16	G6014	RSW PG 16	.890	22,6	1.187	30,1		
Pg 21	G6015	RSW PG 21	1.120	28,4	1.300	33,0		
Pg 29	G6016	RSW PG 29	1.475	37,5	1.725	43,8		
Metric Hubs								
M12	G6020	RSW M12	.475	12,1	.740	18,8	.076	1,9
M16	G6021	RSW M16	.635	16,1	.865	22,0		
M20	G6022	RSW M20	.790	20,1	1.050	26,7		
M25	G6023	RSW M25	.990	25,1	1.300	33,0		
M32	G6024	RSW M32	1.270	32,3	1.725	43,8		

Standard color black.

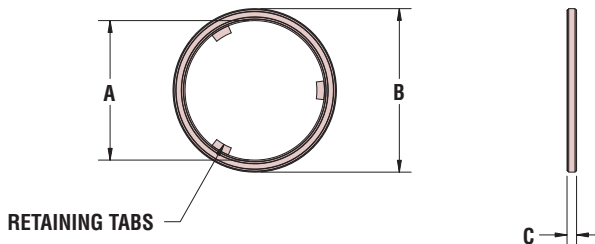

- Retaining tabs hold washer on threads for easier assembly.
- Liquid tight, dust tight, and oil tight at enclosure.
- Suitable for wet locations requiring a separate gasket between the box and fitting.
- Also suitable for other panel sealing applications.
- Easy to install since washers seal off on the perimeter, not on the connector threads.
- Special double sealing ridges compensate for minor unevenness at enclosure.

Material SBR (Styrene Butadiene)
 Flammability Rating HB
 Temperature Range -4°F (-20°C) to 212°F (100°C)

“Stay Connected” with



Liquid Tight Cordgrips

a PennEngineering® Company



Heyco® Nylon Locknuts

NPT Thread – Straight NPS Threads for use with NPT Threaded Fittings

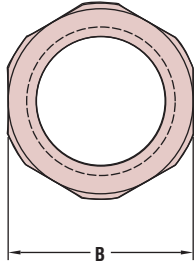
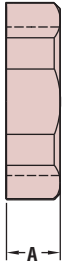

THREAD TYPE AND SIZE	PART NO. BULK		PART NO. 100 PACK		DESCRIPTION	PART DIMENSIONS			
	Black	Gray	Black	Gray		A		B	
						Thickness	Wrenching Flats	in.	mm.
1/4 NPT	M9142	M9143	3269	3270	NLN 1/4 NPT	.265	6,7	.748	19,0
3/8 NPT	8461	8462	3271	3272	NLN 3/8 NPT	.265	6,7	1.058	26,9
1/2 NPT	8463	8464	3273	3274	NLN 1/2 NPT	.265	6,7	1.058	26,9
3/4 NPT	8465	8466	3275	3276	NLN 3/4 NPT	.265	6,7	1.295	32,9
1 NPT	8467	8468	3277	3278	NLN 1 NPT	.265	6,7	1.605	40,8
1-1/4 NPT	M9144	M9145	3279*	–	NLN 1-1/4 NPT	.281	7,1	1.968	50,0
1-1/2 NPT	M9150	M9151	–	–	NLN 1-1/2 NPT	.320	8,1	2.735	69,5
2 NPT	M9156	M9157	–	–	NLN 2 NPT	.375	9,5	2.835	72,0

Standard colors black or gray.
*PN 3279 is a 50 Pack.

PG Thread

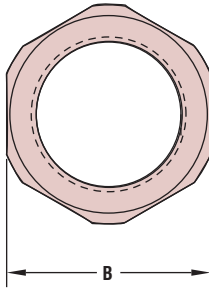
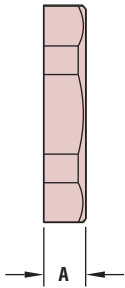

THREAD TYPE AND SIZE	PART NO.		DESCRIPTION	PART DIMENSIONS			
	Black	Gray		A		B	
				Thickness	Wrenching Flats	in.	mm.
PG 7	3165	3166	NLN PG 7	.218	5,5	.750	19,1
PG 9	3167	3168	NLN PG 9	.218	5,5	.859	21,8
PG 11	3169	3170	NLN PG 11	.218	5,5	.937	23,8
PG 13.5	3171	3172	NLN PG 13.5	.250	6,4	1.062	27,0
PG 16	3173	3174	NLN PG 16	.250	6,4	1.171	29,7
PG 21	3175	3176	NLN PG 21	.281	7,1	1.406	35,7
PG 29	3177	3178	NLN PG 29	.281	7,1	1.812	46,0
PG 36	M9146	M9147	NLN PG 36	.281	7,1	2.244	56,9
PG 42	M9152	M9153	NLN PG 42	.320	8,1	2.750	69,9
PG 48	M9158	M9159	NLN PG 48	.375	9,5	2.835	72,0

Standard colors black or gray.

Metric Thread

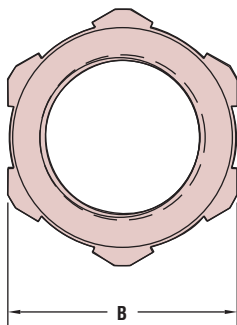
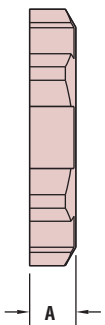

THREAD TYPE AND SIZE	PART NO.		DESCRIPTION	PART DIMENSIONS			
	Black	Gray		A		B	
				Thickness	Wrenching Flats	in.	mm.
M12	M9130	M9131	NLN M12	.218	5,5	.750	19,1
M16	M9132	M9133	NLN M16	.218	5,5	.870	22,1
M20	M9134	M9135	NLN M20	.245	6,2	1.062	27,0
M25	M9136	M9137	NLN M25	.281	7,1	1.378	35,0
M32	M9138	M9139	NLN M32	.281	7,1	1.614	41,0
M40	M9140	M9141	NLN M40	.281	7,1	1.968	50,0
M50	M9148	M9149	NLN M50	.320	8,1	2.750	69,9
M63	M9154	M9155	NLN M63	.375	9,5	2.850	72,4

Standard colors black or gray.

*Quick
Specs*

Material	Nylon 6/6
Flammability Rating	94V-2 Standard—Consult Heyco for VO material
Temperature Range	-22°F (-30°C) to 221°F (105°C)

“Stay Connected” with



Liquid Tight Cordgrips

a PennEngineering® Company

Heyco® Metal Locknuts

NPT Thread – Straight NPS Threads for use with NPT Threaded Fittings

THREAD TYPE AND SIZE	STAMPED STEEL		ZINC DIE-CAST	
	PART NO.	DESCRIPTION	PART NO.	DESCRIPTION
1/4 NPT	2238	LN 1/4*	-	-
3/8 NPT	2242	LN 3/8*	-	-
1/2 NPT	2250	LN 1/2	9800	LN 1/2 DC
3/4 NPT	2251	LN 3/4	9801	LN 3/4 DC
1 NPT	2252	LN 1	9802	LN 1 DC
1-1/4 NPT	9806	LN 1-1/4	9803	LN 1-1/4 DC
1-1/2 NPT	9807	LN 1-1/2	9804	LN 1-1/2 DC
2 NPT	9808	LN 2	9805	LN 2 DC
2-1/2 NPT	9809	LN 2-1/2	-	-
3 NPT	9810	LN 3	-	-

*Wrenching flats are not crenellated

PG Thread – Nickel-Plated Brass

THREAD TYPE AND SIZE	PART NO.	DESCRIPTION	PART DIMENSIONS			
			A Thickness		B Wrenching Flats	
			in.	mm.	in.	mm.
PG 7	2257	Brass LN PG 7	.110	2,8	.591	15,0
PG 9	2258	Brass LN PG 9	.110	2,8	.709	18,0
PG 11	2259	Brass LN PG 11	.118	3,0	.827	21,0
PG 13.5	2260	Brass LN PG 13	.118	3,0	.906	23,0
PG 16	2261	Brass LN PG 16	.118	3,0	1.024	26,0
PG 21	2262	Brass LN PG 21	.138	3,5	1.261	32,0
PG 29	2263	Brass LN PG 29	.158	4,0	1.615	41,0
PG 36	2268	Brass LN PG 36	.197	5,0	2.009	51,0
PG 42	2269	Brass LN PG 42	.197	5,0	2.364	60,0

Metric Thread – Nickel-Plated Brass

THREAD TYPE AND SIZE	PART NO.	DESCRIPTION	PART DIMENSIONS			
			A Thickness		B Wrenching Flats	
			in.	mm.	in.	mm.
M6 x 1	2243	Brass LN M6	.110	2,8	.354	9,0
M8 x 1,25	2244	Brass LN M8	.110	2,8	.433	11,0
M10 x 1,5	2245	Brass LN M10	.110	2,8	.512	13,0
M12 x 1,5	2246	Brass LN M12	.118	3,0	.591	15,0
M16 x 1,5	2247	Brass LN M16	.118	3,0	.748	19,0
M20 x 1,5	2248	Brass LN M20	.138	3,5	.945	24,0
M25 x 1,5	2249	Brass LN M25	.138	3,5	1.181	30,0
M32 x 1,5	2253	Brass LN M32	.177	4,5	1.417	36,0
M40 x 1,5	2254	Brass LN M40	.177	4,5	1.811	46,0
M50 x 1,5	2255	Brass LN M50	.217	5,5	2.165	55,0



• DFARS Compliant

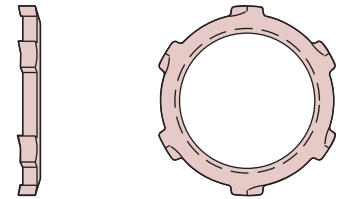

Stamped Steel Nut

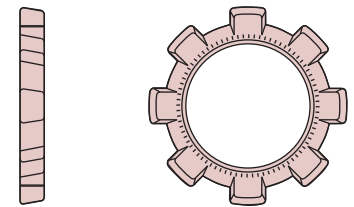

Zinc Die-cast Nut



Nickel-Plated Brass

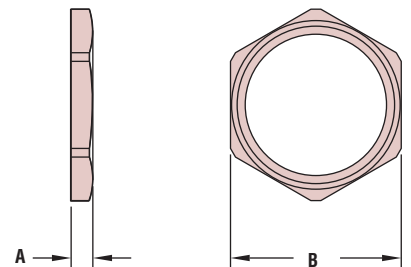



Heyco® TPE Liquid Tight Hole Plugs

Standard 85 Durometer Plugs

Maximum Panel Thickness .125" (3,2 mm)

Mounting Hole Diameter Range: .500" (12,7 mm) to 1.375" (34,9 mm)

- Oil tight, rain tight, submersible.
- UL certified for outdoor applications.
- Install with fingertip pressure (no tool required).
- Multiple nominal sizes fit .500" (12,7 mm) to 1.000" (25,4 mm) true size mounting holes.
- Three trade sizes fit 1/2" to 1" knock-out holes.
- Lock firmly in boxes from .03" (0,8 mm) to .13" (3,2 mm) thick.
- True sizes are UL recognized under Underwriters' Laboratories File E51579 and CSA certified by Canadian Standard Association File 8919.
- Trade sizes are UL listed under Underwriters' Laboratories File E51579 and CSA certified by Canadian Standard Association File 081067C. Now certified for **NEMA 4 and 4X applications.**

MOUNTING HOLE DIAMETER		PART NO. Black	DESCRIPTION	UL or RA	PART DIMENSIONS					
in.	mm.				A Head Diameter		B Overall Height		C Head Thickness	
.500	12,7	3830	KOS LT 500	RA	.91	23,1	.45	11,4	.29	7,4
.625	15,9	3834	KOS LT 625	RA	1.03	26,2	.47	11,9	.31	7,9
.750	19,1	3831	KOS LT 750	RA	1.15	29,2	.51	13,0	.35	8,9
.875	22,2	3833	KOS LT 1/2	UL	1.23	32,5	.50	13,5	.36	9,1
1.000	25,4	3832	KOS LT 1000	RA	1.41	35,8	.56	14,2	.40	10,2
1.093	27,8	3835	KOS LT 3/4	UL	1.53	38,6	.55	14,0		
1.375	34,9	3837	KOS LT 1	UL	1.78	45,2	.57	14,5	.42	10,7

Available in black only.

Low 75 Durometer Plugs

Maximum Panel Thickness .125" (3,2 mm)

Mounting Hole Diameter Range: .875" (22,2 mm) to 1.375" (34,9 mm)

MOUNTING HOLE DIAMETER*		PART NO.		DESCRIPTION	UL or RA	PART DIMENSIONS*					
in.	mm.	Black	Gray			A Head Diameter		B Overall Height		C Head Thickness	
.875	22,2	3833FN	3833FP	KOS LT 1/2 LD	UL	1.23	32,5	.53	13,5	.36	9,1
1.093	27,8	3835FN	3835FP	KOS LT 3/4 LD	UL	1.53	38,6	.55	14,0	.40	10,2
1.375	34,9	3837FN	3837FP	KOS LT 1 LD	UL	1.80	45,2	.56	14,3	.42	10,7

Standard colors black and gray.

*Consult Heyco for other Liquid Tight Hole Plug sizes in Low Durometer material.

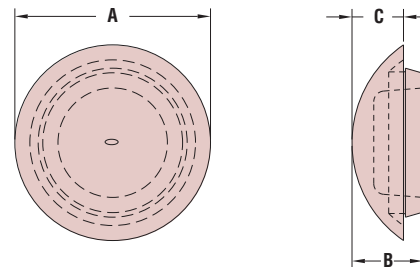

Quick Specs

Material	85 Durometer 75 Durometer	TPE-Hardness 85 Shore A TPE-Hardness 75 Shore A
Certifications	Trade Sizes (1/2, 3/4, 1)	UL Listed under Underwriters' Laboratories File E51579
	True Sizes (all others)	CSA Certified by Canadian Standard Association File 081067C
Flammability Rating		RA Recognized under Underwriters' Laboratories File E51579
		CSA Certified by Canadian Standard Association File 8919
Temperature Range		94V-0 -81°F (-60°C) to 275°F (135°C)

“Stay Connected” with



Liquid Tight Cordgrips

a PennEngineering® Company

Consult Heyco for Colors Other Than Black



HEYCo-molded™ Liquid Tight Break-Thru Plugs

Mounting Hole Diameter Range: .500" (12,7 mm) to 1.500" (38,1 mm)*

PANEL DIMENSIONS				CABLE DIAMETER RANGE		PART NO. Black	PACKAGING		DESCRIPTION	PART DIMENSIONS			
Thickness at Locking Finger Steps		Mounting Hole Diameter*					BULK (Standard)	SMALL PACK **		A Head Diameter		B Overall Height	
in.	mm.	in.	mm.	in.	mm.				in.	mm.	in.	mm.	
With Five Locking Finger Steps – For Panels up to .063" (1,6 mm) Thick													
.02	0,5	.500	12,7	.08 - .20	2,0 - 5,1	C2008	1000	10	LTBP 500-063	.92	23,4	.32	8,1
		.625	15,9	.13 - .38	3,3 - 9,5	C2012	1000	10	LTBP 625-063	1.03	26,2		
.03	0,8	.750	19,1	.18 - .40	4,4 - 10,2	C2016	1000	10	LTBP 750-063	1.15	29,2		
		.875	22,2	.13 - .45	3,3 - 11,4	C2020	1000	10	LTBP 875-063	1.28	32,5		
.04	1,0	1.000	25,4	.20 - .72	5,1 - 18,2	C2022	1000	10	LTBP 1000-063	1.43	36,3		
		1.093	27,8	.25 - .77	6,4 - 19,4	C2024	1000	10	LTBP 1093-063	1.53	38,9		
With Seven Locking Finger Steps – For Panels from .063" (1,6 mm) to .250" (6,4 mm) Thick													
.06	1,6	.500	12,7	.08 - .20	2,0 - 5,1	C2058	1000	10	LTBP 500-250	.92	23,4	.63	15,9
		.625	15,9	.13 - .38	3,3 - 9,5	C2062	1000	10	LTBP 625-250	1.03	26,2		
.08	2,0	.750	19,1	.18 - .40	4,4 - 10,2	C2066	1000	10	LTBP 750-250	1.15	29,2		
		.875	22,2	.13 - .45	3,3 - 11,4	C2070	1000	10	LTBP 875-250	1.28	32,5		
.09	2,4	1.000	25,4	.20 - .72	5,1 - 18,2	C2072	1000	10	LTBP 1000-250	1.43	36,3		
		1.093	27,8	.25 - .77	6,4 - 19,4	C2074	1000	10	LTBP 1093-250	1.53	38,9		
.13	3,2	1.375	34,9	.30 - .95	7,6 - 24,1	C2080	1000	10	LTBP 1375-250	1.80	45,7	.67	17,0
		1.500	38,1	.38 - 1.0	69,5 - 26,9	C2082	1000	10	LTBP 1500-250	1.93	49,0		

- These **co-molded** nylon and elastomer parts function as **Liquid Tight Plugs** with an IP 67/68 rating, yet can be pierced by **round wire, cable or tubing** to function as **Liquid Tight Bushings** with the same resulting IP 67/68 rating.
- **Certified by UL under UL 635**
- For use in panels as thin as .02" (0,5 mm) and as thick as .25" (6,4 mm).
- Provide liquid tight closure when used as a plug. When pierced, function as a liquid tight bushing that convert raw edged holes to smooth, neat, insulated holes.
- Used as a liquid tight bushing, HEYCo-molded Liquid Tight Break-Thru Plugs insulate and mechanically protect electrical and telecommunications cable, tubing, hose, rope, and utility lines.
- Locking fingers snap into holes with fingertip pressure.
- Locking fingers in fractional increments up to the maximum panel thickness.
- Withstand a push back force of greater than 35 pounds.
- Available in multiple sizes for use in .500" (12,7 mm) to 1.500" (38,1 mm) diameter holes.

Standard color black. Consult Heyco for other colors.

*Consult Heyco for other Mounting Hole Diameters. Our Axcell Rapid Response Team is ready to meet your requirements.

**To order Small Packs, please add the suffix -P to Part No.; e.g., C2008-P

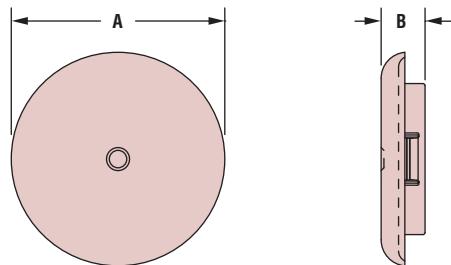

Materials	Nylon 6/6 and TPE
Certifications	Recognized under the Component Program of Underwriters' Laboratories File E15331
Flammability Rating	HB
Temperature Range	-40°F (-40°C) to 212°F (100°C)
IP Rating	IP 67/68

Quick Specs

“Stay Connected” with



Liquid Tight Cordgrips

a PennEngineering® Company

**NO O-RING
REQUIRED!**



Heyco® Liquid Tight Threaded Plugs

Liquid Tight with Integral Sealing Ring
Hex Head with slot

- Integral sealing ring ensures a superior seal at mounting hole location, every time.
- IP 68 Rated.
- **UL Rated for type NEMA 3R, 4 and 4X applications.**
- Provide a liquid-tight seal up to 70 psi.
- Threaded plugs for hydraulic and pneumatic applications.
- Seal threaded openings and protect against contamination and moisture.
- Lower cost option over brass or steel NPT and PG plugs.
- Non-corrosive—resist salt water, weak acids, gasoline, alcohol, oil, grease, and common solvents.
- Resist oil and heat up to 221°F (105°C).
- Approximate Head Thickness: .21" (5,3 mm). Thickness may vary.
- Hex shaped head with slot for wrench or screwdriver installation.
- Electrically non-conductive Nylon 6/6.

THREAD TYPE/SIZE	PART NO.			DESCRIPTION	PART DIMENSIONS			
	Black	Gray	V-O Black		A Wrenching Flats		B Overall Length	
					in.	mm.	in.	mm.
NPT								
NPT 1/4	3544B	3544	-	LTPP NPT 1/4	.63	16,0	.66	16,8
NPT 3/8	3545B	3545	-	LTPP NPT 3/8	.83	21,1	.69	17,5
NPT 1/2	3546B	3546	V3546*	LTPP NPT 1/2	.98	24,9	.81	20,6
NPT 3/4	3547B	3547	V3547*	LTPP NPT 3/4	1.29	32,8	.86	21,8
NPT 1*	3548B	3548	V3548	LTPP NPT 1	1.74	44,2	1.05	26,7
NPT 1-1/4*	3549B	3549	V3549	LTPP NPT 1-1/4	2.06	52,3	1.08	27,4
PG – For PG Thread Specifications, see page 3-57								
PG 7	3574B	3574	-	LTPP PG 7	.63	16,0		
PG 9	3575B	3575	-	LTPP PG 9	.83	21,1	.53	13,5
PG 13.5	3576B	3576	-	LTPP PG 13.5	.98	24,9	.62	15,8
PG 21	3401B	3401	-	LTPP PG 21	1.29	32,8	.68	17,3
PG 29*	3578B	3578	-	LTPP PG 29	1.74	44,2	.87	22,1
PG 36*	3579B	3579	-	LTPP PG 36	2.06	52,3	.78	19,8
Metric								
M12	3582B	3582	-	LTPP M12	.63	16,0		
M16	3583B	3583	-	LTPP M16	.83	21,1	.53	13,5
M20	3584B	3584	-	LTPP M20	.98	24,9	.62	15,8
M32*	3586B	3586	-	LTPP M32	1.74	44,2	.87	22,1
M40*	3587B	3587	-	LTPP M40	2.06	52,3	.78	19,8

Standard colors black and gray. Consult Heyco for other colors and sizes in V-O material.

*Not cURus

Available in Small Packs

NEW

PART NO.	DESCRIPTION	QTY
3546-P	LTPP NPT 1/2 GRAY 100PK	100
3547-P	LTPP NPT 3/4 GRAY 100PK	100
3548-P	LTPP NPT 1 GRAY 100PK	100
3549-P	LTPP NPT 1-1/4 GRAY 50PK	50

Standard color gray.

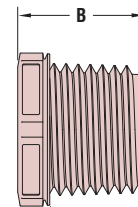
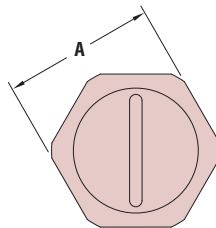

INTEGRAL SEALING RING

*Quick
Specs*

Material	Nylon 6/6
Certifications	Recognized under the Component Program of Underwriters' Laboratories File E330194 to both Canadian and U.S. requirements.
Flammability Rating	94V-2
Temperature Range	-40°F (-40°C) to 221°F (105°C)
IP Rating	IP 68 (70 PSI, 5 BAR)

“Stay Connected” with



Liquid Tight Cordgrips

a PennEngineering® Company

Heyco® PG and Metric Threaded Plugs

Round Head with Slot

Plastic



THREAD TYPE/SIZE	PART NO.		DESCRIPTION	PART DIMENSIONS			
	Gray	Black		A Head Diameter		B Overall Height	
				in.	mm.	in.	mm.

PG Threads – Polystyrene

PG 7	3405	3405B	TP PG 7	.59	15,0	.32	8,0
PG 9	3407	3407B	TP PG 9	.75	19,0	.37	9,5
PG 11	3402	3402B	TP PG 11	.87	22,0		
PG 13	3412	3412B	TP PG 13	.98	25,0	.39	10,0
PG 16	3414	3414B	TP PG 16	1.06	27,0		
PG 21	3416	3416B	TP PG 21	1.30	33,0		
PG 29	3418	3418B	TP PG 29	1.73	44,0	.47	12,0
PG 36	3415	3415B	TP PG 36	2.17	55,0		
PG 42	3400	3400B	TP PG 42	2.44	62,0	.55	14,0
PG 48	3417	3417B	TP PG 48	2.72	69,0	.63	16,0

Metric Threads – Nylon

M12 x 1,5	3403	3403B	TP M12	.59	15,0		
M16 x 1,5	3404	3404B	TP M16	.79	20,0	.41	10,5
M20 x 1,5	3406	3406B	TP M20	.95	24,0		
M25 x 1,5	3408	3408B	TP M25	1.18	30,0	.51	13,0
M32 x 1,5	3409	3409B	TP M32	1.48	37,0	.53	13,5
M40 x 1,5	3410	3410B	TP M40	1.81	46,0	.55	14,0
M50 x 1,5	3411	3411B	TP M50	2.20	56,0	.63	16,0
M63 x 1,5	3413	3413B	TP M63	2.76	70,0	.71	18,0

Standard color gray and black. Consult Heyco for other colors.

- Used to close unneeded PG and Metric threaded holes when other threaded accessories may be added at a later time.
- Designed with slot for screwdriver installation
- For PG Threaded specifications, see page 3-57.
- For Heyco Snap-In Metric Dome Plugs, see page 6-30.
- Nickel-Plated Brass Plugs are ideal where extra durability and strength are needed such as harsh environmental conditions.
- Nickel-Plated Brass Plugs include NBR O-ring

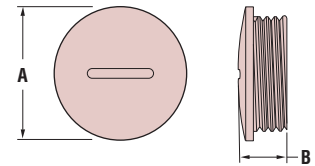

Nickel-Plated Brass

ALL NEW PRODUCTS!

THREAD TYPE/SIZE	PART NO.	DESCRIPTION	PART DIMENSIONS			
			A Head Diameter		B Overall Height	
			in.	mm.	in.	mm.

PG Threads

PG 7	13405	BRASS TP PG 7	.55	14,0	.31	8,0
PG 9	13407	BRASS TP PG 9	.67	17,0		
PG 11	13402	BRASS TP PG 11	.79	20,0	.35	9,0
PG 13	13412	BRASS TP PG 13	.87	22,0		
PG 16	13414	BRASS TP PG 16	.94	24,0	.37	9,5
PG 21	13416	BRASS TP PG 21	1.18	30,0	.43	11,0
PG 29	13418	BRASS TP PG 29	1.54	39,0	.47	12,0
PG 36	13415	BRASS TP PG 36	1.97	50,0	.59	15,0
PG 42	13400	BRASS TP PG 42	2.36	60,0		
PG 48	13417	BRASS TP PG 48	2.56	65,0	.63	16,0

Metric Threads

M6 x 1.0	13397	BRASS TP M6*	.35	9,0		
M8 x 1.25	13398	BRASS TP M8*	.39	10,0		
M10 x 1.5	13399	BRASS TP M10*	.47	12,0	.31	8,0
M12 x 1,5	13403	BRASS TP M12	.55	14,0		
M16 x 1,5	13404	BRASS TP M16	.75	19,0		
M20 x 1,5	13406	BRASS TP M20	.94	24,0	.35	9,0
M25 x 1,5	13408	BRASS TP M25	1.10	28,0	.43	11,0
M32 x 1,5	13409	BRASS TP M32	1.38	35,0	.47	12,0
M40 x 1,5	13410	BRASS TP M40	1.77	45,0	.55	14,0
M50 x 1,5	13411	BRASS TP M50	2.17	55,0	.59	15,0
M63 x 1,5	13413	BRASS TP M63	2.76	70,0	.63	16,0

* Metric course-pitch threads

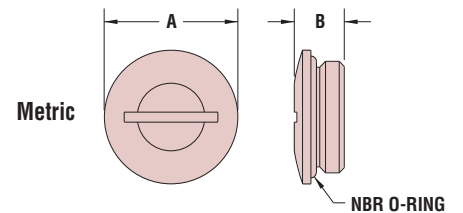
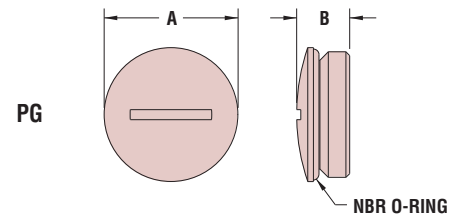

	Plastic TP Plugs	Brass TP Plugs
Material	Nylon 6/6 or Impact Resistant Polystyrene	Nickel-Plated Brass with an NBR O-ring
Flammability Rating	94V-2	
Temperature Range	-4° F (-20° C) to 176° F (80° C)	-40° F (-40° C) to 212° F (100° C)
IP Rating	IP 50	IP 68

Quick Specs

“Stay Connected” with



Liquid Tight Cordgrips

a PennEngineering® Company

**NO O-RING
REQUIRED!**



HEYClean™ Liquid Tight Threaded Vent Plugs

With Integral Sealing Ring and Liquid Tight Filter

- Integral sealing ring ensures a **superior seal** at mounting hole location, every time; **IP 65, 67 and 68 Rated**.
- Allow the passage of air for ventilation and heat dissipation, yet prevent moisture intrusion, remain liquid tight.
- Maximum airflow: ≥ 16.6 LPM/3.7cm² @ 13.5 psi.
- UL Rated for Type NEMA 3R, 4, and 4X applications.
- Filter membrane prevents moisture and particulate contamination in electronic enclosures.
- Pressure compensating seal prevents buildup of pressure inside of electronic enclosures due to environmental temperature cycling.
- Quick and easy installation into Threaded (LTTVP) and Clearance (LTSV) holes.
- Membrane seal is ultrasonically welded to nylon body.
- Lower cost option over metal or steel plugs.
- Approximate Head Thickness: .21" (5,3 mm). Thickness may vary.
- Hex shaped head for wrench installation (LTTVP only).
- Electrically non-conductive Nylon 6/6.
- Quick and easy **Snap-in** installation into Clearance Holes.
- All sizes and types feature (9) .094" (2,4 mm) diameter vent holes.
- **Snap-In** plugs for panel and housing applications.
- Lower cost option over brass or steel plugs.
- Snap into a range of panel thicknesses up to .125" (3,2 mm) with no tools (LTSV only).

THREAD Type/Size	PART NO.		DESCRIPTION	PART DIMENSIONS			
	Black	Gray		A Wrenching Flats		B Overall Length	
				in.	mm.	in.	mm.
NPT							
NPT 1/4	3544VB	3544V	LTTVP NPT 1/4	.63	16,0	.66	16,8
NPT 3/8	3545VB	3545V	LTTVP NPT 3/8	.83	21,0	.69	17,5
NPT 1/2	3546VB	3546V	LTTVP NPT 1/2	.98	24,9	.81	20,6
NPT 3/4	3547VB*	3547V*	LTTVP NPT 3/4	1.29	32,8	.86	21,8
PG – For PG Thread specifications, see page 3-49							
Pg 7	3574VB	3574V	LTTVP Pg 7	.63	16,0	.53	13,5
Pg 9	3575VB	3575V	LTTVP Pg 9	.83	21,0		
Pg 13.5	3576VB	3576V	LTTVP Pg 13.5	.98	24,9	.62	15,8
Pg 21	3401VB	3401V	LTTVP Pg 21	1.29	32,8	.76	19,3
Metric							
M12	3582VB	3582V	LTTVP M12	.63	16,0	.53	13,5
M16	3583VB	3583V	LTTVP M16	.83	21,0		
M20	3584VB	3584V	LTTVP M20	.98	24,9	.62	15,8

Standard color Black. Consult Heyco for other colors.

*IP 65 rated.

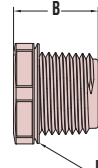
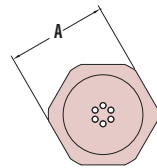

Threaded Vent Plug

INTEGRAL SEALING RING

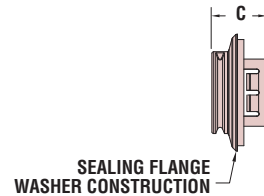

Snap-In Vent Plug

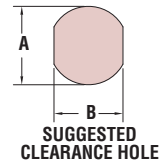

SUGGESTED CLEARANCE HOLE

HEYClean™ Liquid Tight Snap-In Vent Plugs

With Integral Sealing Flange/Washer and Liquid Tight Filter

Mounting Hole Diameter Range: .500" (12,7 mm) to 1.125" (28,6 mm)

A Mounting Hole Dia.*	PART NO.	DESCRIPTION	PART DIMENSIONS			
			B To Prevent Rotation		C Max. O.A. Length	
			in.	mm.	in.	mm.
.500	3481VB	LTSV 500	.45	11,4	.600	15,2
.875	3486VB	LTSV 875	.77	19,6	.620	15,7
1.125	3488VB	LTSV 1125	1.00	25,4	.660	16,8

Standard color black. Consult Heyco for other colors.

*Consult Heyco for additional sizes.

Quick
Specs

Material

Nylon 6/6 bodies with an Acrylic Copolymer Filter

Certifications



Recognized under the Component Program of Underwriters' Laboratories, File E330194 to both Canadian and U.S. Requirements

Flammability Rating

94V-2

Temperature Range

-40°F (-40°C) to 221°F (105°C)

IP Rating

IP 65/67/68

“Stay Connected” with



Liquid Tight Cordgrips

a PennEngineering® Company



HEYClean® Brass Pressure Equalization and Drain Plugs

For Pressure Equalization and Drainage Applications

THREAD Type/Size	PART NO.		DESCRIPTION	PART DIMENSIONS								PROTECTION CLASS
	STD.	EXP*		A Clearance Hole		B Overall Length		C Thread Length		D Wrenching Flats		
		NEW		in.	mm.	in.	mm.	in.	mm.	in.	mm.	

Liquid Tight Pressure Equalization Plugs – Ultimate in Liquid Tight Pressure Equalization

M12 x 1.5	4350	14350	BRASS LTPEP M12	.47	12,0	.69	17,5	.31	8,0	.71	18,0	IP 66,67,68
M16 x 1.5	4351	14351	BRASS LTPEP M16	.63	16,0							
M20 x 1.5	4352	14352	BRASS LTPEP M20	.79	20,0	.71	18,0	.31	8,0	.87	22,0	

Liquid Resistant Pressure Equalization Plugs – Maximize Airflow for Extreme Pressure and Moisture Fluctuations

M12 x 1.5	4354	–	BRASS LRPEP M12	.47	12,0	.69	17,5	.31	8,0	.71	18,0	IP 55, x9K
M16 x 1.5	4355	–	BRASS LRPEP M16	.63	16,0							
M20 x 1.5	4356	–	BRASS LRPEP M20	.79	20,0	.71	18,0	.31	8,0	.87	22,0	

Threaded Drain Plug – For Applications Where Condensation Is Expected**

M12 x 1.5	4357	–	BRASS TDP M12	.47	12,0	.77	19,5	.39	10,0	.71	18,0	IP 4x
M16 x 1.5	4358	–	BRASS TDP M16	.63	16,0							
M20 x 1.5	4359	–	BRASS TDP M20	.79	20,0	.79	20,0	.39	10,0	.87	22,0	

Stainless Steel available. Consult Heyco.

*Certified in accordance with IECEx and ATEX

**Heyco Drainage Plug Brass Locknuts sold separately

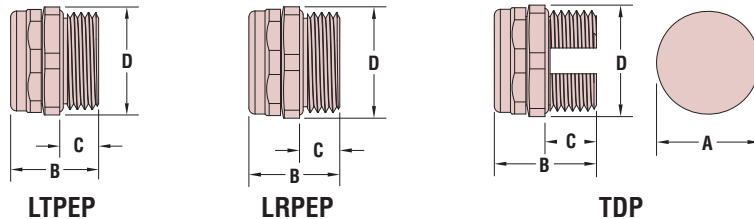

HEYClean® Drain Plug Brass Locknuts

For Use with HEYClean™ Threaded Drain Plugs

THREAD Type/Size	PART NO.	DESCRIPTION	PART DIMENSIONS			
			A Thickness		B Wrenching Flats	
			in.	mm.	in.	mm.
M12 x 1.5	4360	BRASS DPLN M12	.18	4,5	.59	15,0
M16 x 1.5	4361	BRASS DPLN M16	.22	5,5	.75	19,0
M20 x 1.5	4362	BRASS DPLN M20	.22	5,5	.94	24,0

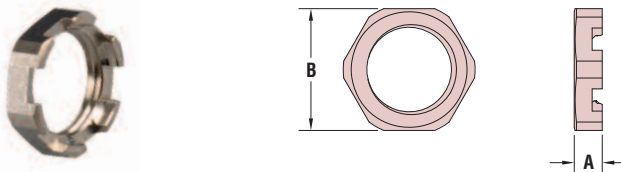

Material	Nickel-Plated Brass
Temperature Range	-40°F (-40°C) to 230°F (110°C)
IP Rating	Membrane - IP66/IP68/IP69 Filter Disc - IP55/ IPX9K Drainage Element - IP4X

Pressure Equalization Plugs

- Allow the passage of air for ventilation and heat dissipation, yet prevent moisture intrusion.
- Filter membrane prevents moisture and particulate contamination in electronic enclosures.
- Pressure compensating seal prevents buildup of pressure inside of electronic enclosures due to environmental temperature cycling.
- Quick and easy installation into Clearance or Threaded Holes.
- **Nickel-plated finish over brass provides excellent corrosion resistance and durability.**
- Head Thickness: .37" (9,5 mm) to .39" (10 mm).
- Hex shaped body for wrench installation.
- Filter element:
Liquid Tight Membrane: Polyethersulfone (PES)
Sintered Disc: Bronze
- DFARS Compliant

Drain Plugs

- Drainage Plugs are ideal for applications where condensation is expected.
 - Stainless steel mesh allows water to drain quickly, but protects enclosure from bugs and dust.
 - Drainage Plugs feature a “cutout” section to allow water to completely drain from enclosure, and should be installed at enclosure’s lowest point.
 - Head Thickness: .37" (9,5 mm) to .39" (10 mm).
 - Hex shaped body for wrench installation.
 - DFARS Compliant
- ### Drain Plug Locknuts
- Quick and easy installation into Clearance Holes only.
 - Locknuts feature special “cutout” to allow water to completely drain from enclosure, when used with HEYClean™ Threaded Drain Plugs.
 - DFARS Compliant

Heyco® Liquid Tight Cordgrips

INSTALLATION INSTRUCTIONS for NON THREADED or Clearance mounting holes:

For torque information, see page 3-58 or visit the Cordgrips section on www.heyco.com.

1. Be sure that hole is free of burrs and panel surface around hole is smooth and free of debris.
2. Insert the fitting's lower threaded portion through the mounting hole and hand-tighten the LOCKNUT as far as possible. Hold the BODY hex stationary with a wrench. Using a six-pointed socket or six-pointed wrench, tighten the LOCKNUT firmly in place. **To see Heyco's Torque Chart (LTF's, LTCG's, SCG's & Brass), visit the Cordgrips section on www.heyco.com for suggested torque values.** Check to make sure the BODY hex is held flush and tight to the panel to insure a tight seal.
3. Insert the cable through the fitting to the desired position.
4. Hand-tighten the SEALING nut as far as possible. Hold the BODY hex stationary with a wrench. Using a second wrench, tighten the sealing nut until the cable is securely held in place. **To see Heyco's Torque Chart (LTF's, LTCG's, SCG's & Brass), visit the Cordgrips section on www.heyco.com for suggested torque values.**
5. To disassemble for cable replacement, use a wrench to hold the BODY hex stationary and loosen the SEALING nut with a second wrench. Grip the disconnected cable and pull while turning the cable in the counter-clockwise direction.

Alternate Installation Instructions:

1. Insert the cable through the fitting to the desired position.
2. Hand-tighten the SEALING nut as far as possible. Hold the BODY hex stationary with a wrench. Using a second wrench, tighten the sealing nut until the cable is securely held in place. **To see Heyco's Torque Chart (LTF's, LTCG's, SCG's & Brass), visit the Cordgrips section on www.heyco.com for suggested torque values.**
3. Insert the fitting's lower threaded portion through the mounting hole and hand-tighten the LOCKNUT as far as possible. Hold the BODY hex stationary with a wrench. Using a six-pointed socket or six-pointed wrench, tighten the LOCKNUT firmly in place. **To see Heyco's Torque Chart (LTF's, LTCG's, SCG's & Brass), visit the Cordgrips section on www.heyco.com for suggested torque values.** Check to make sure the BODY hex is held flush and tight to the chassis to insure a tight seal.
4. To disassemble for cable replacement, use a wrench to hold the BODY hex stationary and loosen the SEALING nut with a second wrench. Grip the disconnected cable and pull while turning the cable in the counter-clockwise direction.

Heyco® Liquid Tight Cordgrips

INSTALLATION INSTRUCTIONS for THREADED mounting holes:

For torque information, see page 3-58 or visit the Cordgrips section on www.heyco.com.



1. Be sure that hole is free of burrs and panel surface around hole is smooth and free of debris.
2. Using the hex portion on the body (not the sealing nut), screw the fitting tightly into the threaded mounting hole.
3. Insert the cable through the fitting to the desired position.
4. Hand-tighten the SEALING nut as far as possible. Hold the BODY hex stationary with a wrench. Using a second wrench, tighten the SEALING nut until the wire is securely held in place.
5. Using a wrench on the BODY hex, check to make sure the fitting is still screwed tightly into the panel.
6. To disassemble for cable replacement, use a wrench to hold the BODY hex stationary and loosen the SEALING nut with a second wrench. Grip the disconnected cable and pull while turning the cable in the counter-clockwise direction.

Heyco-Tite

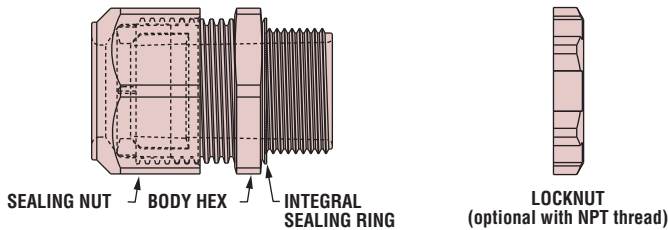

Original Series-35

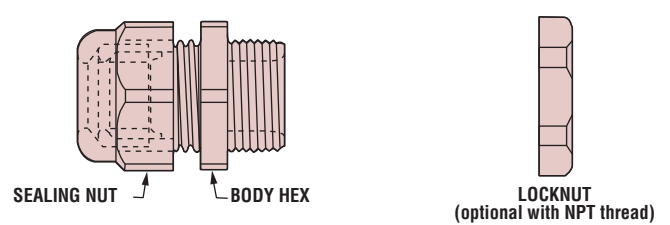

Heyco® PG Thread Taps

For Steel Conduit Threads per DIN 40430*



THREAD TYPE AND SIZE	TAP DRILL DIAMETER mm.	DESCRIPTION	PART NO.		PART DIMENSIONS		
			Starting	Finishing	Major Diameter mm.	Overall Length mm.	Thread mm.
PG 7	11,5	PG T 7	0150	0151	12,5	63,0	20,0
PG 9	14,0	PG T 9	0153	0154	15,2	70,0	20,0
PG 11	17,3	PG T 11	0156	0157	18,6	80,0	22,0
PG 13.5	19,0	PG T 13.5	0159	0160	20,4	80,0	22,0
PG 16	21,3	PG T 16	0162	0163	22,5	80,0	22,0
PG 21	27,0	PG T 21	0165	0166	28,3	90,0	22,0
PG 29	35,5	PG T 29	0168	0169	37,0	110,0	25,0

*See page 3-49 for DIN 40430 Specifications.

- Use a starting tap for through-hole applications.
- For blind holes, thread first with a starting tap; finish bottoming the threads with a finishing tap.
- Flank angle 80°.
- Made of high-speed steel with ground threads for greater accuracy to assure optimum performance.
- Suitable for cutting alloy steel, bronze, and stainless.

Heyco® PG Hub Liquid Tight Cordgrip DIN 40430 Specifications

Machined Steel Pipe Thread – Nominal Sizes (mm)

THREAD SIZE AND TYPE	PART DIMENSIONS						
	Outside Dia. d=D	Pitch Dia. d2=D2	Root Dia. d1=D1	Pitch P	No. of Threads Z	Thread Height H1	Thread Radius R
PG 7	12,5	11,89	11,28	1,270	20	0,61	0,14
PG 9	15,2	14,53	13,86	1,410	18	0,67	0,15
PG 11	18,6	17,93	17,26	1,410	18	0,67	0,15
PG 13,5	20,4	19,73	19,06	1,410	18	0,67	0,15
PG 16	22,5	21,83	21,16	1,410	18	0,67	0,15
PG 21	28,3	27,54	26,78	1,588	16	0,76	0,17
PG 29	37,0	36,24	35,48	1,588	16	0,76	0,17
PG 36	47,0	46,24	45,48	1,588	16	0,76	0,17
PG 42	54,0	53,24	52,48	1,588	16	0,76	0,17
PG 48	59,3	58,54	57,78	1,588	16	0,76	0,17

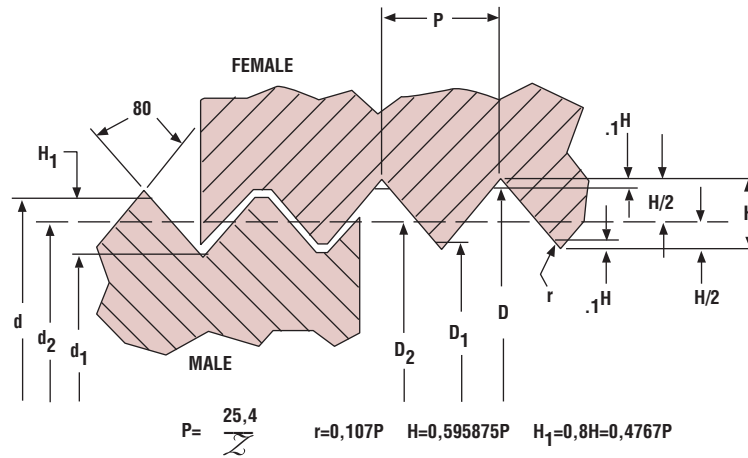

Machined Steel Pipe Thread – Limits (mm)

Plastic Threads may have Modified Tolerances

THREAD SIZE AND TYPE	PART DIMENSIONS													
	Outside Dia. d		M A L E Pitch Dia. d2				Root Dia. d1		O u t s i d e D i a . D		F E M A L E Pitch Dia. D2		R o o t D i a . D1	
	max.	min.	max.	min.	max.	min.	max.	min.	max.	min.	max.	min.		
PG 7	12,5	12,3	11,89	11,69	11,28	11,08	12,65	12,5	12,04	11,89	11,43	11,28		
PG 9	15,2	15,0	14,53	14,33	13,86	13,66	15,35	15,2	14,68	14,53	14,01	13,86		
PG 11	18,6	18,4	17,93	17,73	17,26	17,06	18,75	18,6	18,08	17,93	17,41	17,26		
PG 13,5	20,4	20,2	19,73	19,53	19,06	18,86	20,55	20,4	19,88	19,73	19,21	19,06		
PG 16	22,5	22,3	21,83	21,63	21,16	20,96	22,65	22,5	21,98	21,83	21,31	21,16		
PG 21	28,3	28,0	27,54	27,24	26,78	26,48	28,55	28,3	27,79	27,54	27,03	26,78		
PG 29	37,0	36,7	36,24	35,94	35,48	35,18	37,25	37,0	36,49	36,24	35,73	35,48		
PG 36	47,0	46,7	46,24	45,94	45,48	45,18	47,25	47,0	46,49	46,24	45,73	45,48		
PG 42	54,0	53,7	53,24	52,94	52,48	52,18	54,25	54,0	53,49	53,24	52,73	52,48		
PG 48	59,3	59,0	58,54	58,24	57,78	57,48	59,55	59,3	58,79	58,54	58,03	57,78		

“Stay Connected” with



Liquid Tight Cordgrips

a PennEngineering® Company

Heyco® Liquid Tight Cordgrips Torque Chart

Heyco®-Tite LTCG and SCG

Hub Style	Lock Nut		Sealing Nut	
	in. lbs.	Nm	in. lbs.	Nm
NPT 1/4 Pg 7 M12	15 - 20	1,7 - 2,3	25 - 30	2,8 - 3,4
SCG 500	-	-		
NPT 3/8 Pg 9 M16	33 - 38	3,7 - 4,3	33 - 38	3,7 - 4,3
SCG 625	-	-		
Pg 11 SCG 750	40 - 45	4,5 - 5,1	55 - 65	6,2 - 7,3
NPT 1/2 Pg 13.5 M20	40 - 45	4,5 - 5,1	50 - 55	5,6 - 6,2
SCG 875	-	-		
NPT LL 1/2 Pg 16	40 - 45 100	4,5 - 5,1 11,3	70	7,9
SCG 1000	-	-		
NPT 3/4 Pg 21 M25	75 - 80	8,5 - 9,0	80 - 85	9,0 - 9,6
SCG 1.093 SCG 1.125	-	-		
NPT 1 Pg 29 M32	75 - 80	8,5 - 9,0	100 - 110	11,3 - 12,4
SCG 1.250 SCG 1.375	-	-		
NPT 1-1/4 Pg 36 M40	125 - 135	14,1 - 15,3	145-155	16,4 - 17,5
SCG 1.500 SCG 1.750	-	-		
NPT 1-1/2 Pg 42 M50	255	28,8	188	21,2
SCG 2.000	-	-		
NPT 2 Pg 48 M63	300	33,9	255	28,8
SCG 2.375	-	-		

Original Series-35 LTF

Hub Style	Lock Nut		Sealing Nut	
	in. lbs.	Nm	in. lbs.	Nm
Pg 7	35	4,0	25	2,8
NPT 3/8 Pg 9	40	4,5	40	4,5
Pg 11	45	5,1	65	7,3
NPT 1/2 Pg 13.5	80	9,0	80	9,0
NPT LL 1/2 Pg 16	80 124	9,0 14,0	120	13,6
NPT 3/4 Pg 21	169	19,1	130	14,7
NPT 1 Pg 29	200 - 225 225	22,6 - 25,4 25,4	225 - 250 275	25,4 - 28,2 31,1

Expanded Torque Charts are available on our website.
Visit www.Heyco.com and click on Full Line Catalog.



“Stay Connected” with



Liquid Tight Cordgrips

a PennEngineering® Company

Heyco® Liquid Tight Cordgrips LabKit #8 (Part #3297)



Use Heyco LabKits!

- Heyco LabKits are perfect for product design departments, experimental labs, and for all prototype work.
- Heyco LabKit #8 contains an assortment of our most popular Liquid Tight Cordgrips
- Heyco also offers LabKits for Strain Relief Bushings, Bushings, Hole Plugs, HEYware and Grommets.

HEYCO® Strain Relief Bushings



4-1 Straight-Thru Snap-In Cordgrip Strain Reliefs



4-2 Pigtail Snap-In Cordgrip Strain Reliefs



4-3 Snap-In Universal Strain Reliefs & Romex® Strain Relief

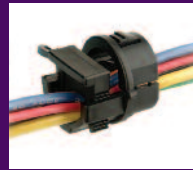

4-4 Removeable Snap-In Ratcheting Strain Reliefs



4-5 ST Lockit Strain Reliefs for Round Cables



4-6 ST Lockit Strain Reliefs for Flat Cables



4-7 RDD Lockit Strain Reliefs - Straight-Thru for Round Cable, .625 Diameter



4-8 RDD Lockit Strain Reliefs - Straight-Thru for Round Cable, .875 Diameter



4-9 RDD Lockit Strain Reliefs - Straight-Thru for Round Cable, 1.109 Diameter



4-10 Lockit Strain Relief Table of UL Approved Round Wire Types



4-11 RDD Lockit Strain Reliefs - Straight-Thru for Flat Cables



4-12 RDD Lockit Strain Reliefs - Pigtail for Round & Flat Cables



4-13 RDD Lockit Strain Reliefs - Right Angle for Round Cables



4-14 RDD Lockit Strain Reliefs - Right Angle for Flat Cables



4-15 Lockit Strain Relief Pre-Assembly Equipment



4-16 Lockit Strain Relief Pre-Assembly Equipment Directory



4-17 Original Strain Reliefs - Straight-Thru for Flat Cable to .500 Diameter



4-18 Original Strain Reliefs - Straight-Thru for Flat Cable to .875 Diameter



4-19 Original Strain Reliefs - Straight-Thru for Round Cable to .500 Diameter



4-20 Original Strain Reliefs - Straight-Thru for Round Cable to .750 Diameter



4-21 Original Strain Reliefs - Straight-Thru for Round Cable to 1.187 Diameter



4-22 Original Strain Relief Bushings - Internal Radii, for Flat Cable



4-23 Original Strain Relief Bushings - Bell Mouth, for Flat and Round Cable



4-24 Original Strain Relief Bushings - Pigtail, for Flat and Round Cable



4-25 Original Strain Relief Bushings - Right Angle for Round Cable



4-26 Original Strain Relief Bushings - Right Angle for Flat Cable



4-27 Original Strain Relief Assembly Plier Instructions & Spares

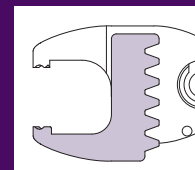

4-28 Original Strain Relief Assembly Pliers Directory



4-29 Original Strain Relief Bushing Air Tool



4-30 Strain Relief Mounting Hole Punches & Metal Strain Reliefs



4-31 Multi-Lockit Strain Reliefs for Round & Flat Cables



4-31 ST Lockit Strain Relief for U-Shape Slot



4-32 Split Panel Strain Reliefs



4-33 In-Line Strain Relief



4-33 Strain Relief LabKit



4-34 Euro CEE Strain Relief & T-Bar



4-35 Brass Clamping Strain Reliefs



4-36 Zinc Die-Cast Box Connectors



4-37 Knock-Out Adapters, Backup Washer & Tool



4-38 Strain Relief Mounting Hole Plugs



4-39 How to Choose a Strain Relief



Heyco® Snap-In Cordgrip Strain Reliefs – Straight-Thru

The Ultimate in Snap-In Strain Relief Protection

For Panels from .062” (1,6 mm) to .125” (3,2 mm) Thick

- **Unique fingers securely lock into a range of panel sizes without use of locknut.**
- Smooth, rounded interior edges for ease of installation.
- Limited intrusion into enclosure where access is tight.
- Rotation prevented when used in Double D mounting holes.
- Easy to install—no tools required.
- Ratchet design of sealing nut assembly provides superior anti-vibration and ensures a firm grip on the cable.
- Available in multiple sizes for cable diameters ranging from .065” (1,7 mm) to 1.560” (39,6 mm).
- We recommend using the fitting with the smallest maximum diameter that will fit your application.
- Meet UL strain relief requirements without bending or kinking the cable.
- Though similar in appearance and function to Heyco-Tite Liquid Tight Cordgrips, Snap-In Cordgrip Strain Reliefs may not be liquid tight at the panel interface. For our complete range of **Liquid Tight** Cordgrips with Integral Sealing Ring, see Section 3.
- Use Heyco **Mounting Hole Plugs** for DD Mounting Holes, or **Heyco Dome Plugs** for round Mounting Holes, to fill blank/unused Mounting Holes and thus allow for a single panel design across multiple applications. See Section 6.
- For Foam Washers, see page 2-20.
- For Double D Mounting Hole Punches, see page 4-30.

WILL FIT THESE CABLES				PART NO.		DESCRIPTION	UL or IEC	PANEL DIMENSIONS						Mounting Hole Plug Part No.
Minimum Diameter		Maximum Diameter		Black	Gray			A Mounting Hole		B To Prevent Rotation		C Max O.A. Length		
in.	mm.	in.	mm.				in.	mm.	in.	mm.	in.	mm.		
.210	5,3	.210	5,3	M4802	M4803	RSCG 500	UL	.500	12,7	.450	11,4	1.21	30,7	2491
.240	6,1	.250	6,4	M4800	M4801	SCG 500								
.210	5,3	.230	5,8	M4808	M4809	RSCG 625	UL	.625	15,9	.550	14,0	1.30	33,0	2497
.210	5,3	.315	8,0	M4806	M4807	SCG 625								
.230	5,8	.260	6,6	M4814	M4815	RSCG 750	UL	.750	19,1	.660	16,8	1.48	37,6	2503
.230	5,8	.400	10,2	M4812	M4813	SCG 750								
.255	6,5	.290	7,4	M4820	M4821	RSCG 875	UL	.875	22,2	.770	19,6	1.46	37,1	2509
.250	6,4	.450	11,4	M4818	M4819	SCG 875								
.300	7,6	.400	10,2	M4826	M4827	RSCG 1000	UL	1.000	25,4	.875	22,2	1.62	41,1	2713*
.350	8,9	.545	13,8	M4824	M4825	SCG 1000								
.385	9,8	.490	12,4	M4832	M4833	RSCG 1093	UL	1.093	27,8	.970	24,6	1.75	44,5	2723*
.435	11,0	.705	17,9	M4830	M4831	SCG 1093								
.385	9,8	.490	12,4	M4838	M4839	RSCG 1125	UL	1.125	28,6	1.000	25,4	1.75	44,5	2717
.435	11,0	.705	17,9	M4836	M4837	SCG 1125								
.490	12,4	.785	19,9	M4844	M4845	RSCG 1250	UL	1.250	31,8	1.125	28,6	2.05	52,1	2740*
.590	15,0	1.000	25,4	M4842	M4843	SCG 1250								
.490	12,4	.785	19,9	M4850	M4851	RSCG 1375	UL	1.375	34,9	1.250	31,8	2.05	52,1	2753*
.590	15,0	1.000	25,4	M4848	M4849	SCG 1375								
.787	20,0	1.020	25,9	M4856	M4857	RSCG 1500	UL	1.500	38,1	1.375	34,9	2.23	56,6	2763*
.875	22,2	1.260	32,0	M4854	M4855	SCG 1500								
.787	20,0	1.020	25,9	M4862	M4863	RSCG 1750	UL	1.750	44,5	1.625	41,3	2.28	57,9	2773*
.875	22,2	1.260	32,0	M4860	M4861	SCG 1750								
1.000	25,4	1.240	31,5	M4868	M4869	RSCG 2000	UL	2.000	50,8	1.875	47,6	2.41	61,2	2959
1.230	31,2	1.560	39,6	M4866	M4867	SCG 2000								
1.160	29,5	1.350	34,3	M4874	M4875	RSCG 2375	UL	2.375	60,3	2.250	57,2	2.50	63,5	consult Heyco
1.450	36,8	1.560	39,6	M4872	M4873	SCG 2375								

Standard color black. Gray parts produced to order, please consult Heyco.

*For round Mounting Hole only. For DD Mounting Hole Plug, consult Heyco.

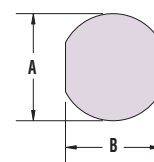
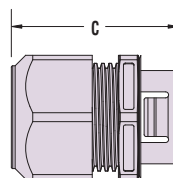

SUGGESTED CLEARANCE HOLE FOR NONTHEADED MOUNTING

Quick Specs

Material
Certifications

Nylon 6/6 w/Buna N Sealing Gland

UL Recognized under Underwriters' Laboratories File E51579

SP Certified by Canadian Standards Association File 093876

Flammability Rating
Temperature Range

94V-2

-04°F (-18°C) to 221°F (105°C)

“Stay Connected” with



Strain Relief Bushings

a PennEngineering® Company



Heyco® Snap-In Cordgrip Strain Reliefs – Pigtail™

The Ultimate in Snap-In Strain Relief Protection

For Panels from .062" (1,6 mm) to .125" (3,2 mm) Thick

WILL FIT THESE CABLES				PART NO.	DESCRIPTION	UL or IEC	PANEL DIMENSIONS						Mounting Hole Plug Part No.
Minimum Diameter		Maximum Diameter					A Mounting Hole	B To Prevent Rotation		C Max O.A. Length			
in.	mm.	in.	mm.	Black			in.	mm.	in.	mm.	in.	mm.	
.210	5,3	.210	5,3	M4902	RSCG 500-7	UL	.500	12,7	.450	11,4	2.50	63,5	2491
.240	6,1	.250	6,4	M4900	SCG 500-7								
.210	5,3	.230	5,8	M4908	RSCG 625-7	UL	.625	15,9	.550	14,0	2.83	71,9	2497
.210	5,3	.315	8,0	M4906	SCG 625-7								
.230	5,8	.260	6,6	M4914	RSCG 750-7	UL	.750	19,1	.660	16,8	3.46	87,9	2503
.230	5,8	.400	10,2	M4912	SCG 750-7								
.255	6,5	.290	7,4	M4920	RSCG 875-7	UL	.875	22,2	.770	19,6	3.86	98,0	2509
.250	6,4	.450	11,4	M4918	SCG 875-7								
.300	7,6	.400	10,2	M4926	RSCG 1000-7	UL	1.000	25,4	.875	22,2	4.31	109,5	2713*
.350	8,9	.545	13,8	M4924	SCG 1000-7								
.385	9,8	.490	12,4	M4932	RSCG 1093-7	UL	1.093	27,8	.970	24,6	4.90	124,5	2723*
.435	11,0	.705	17,9	M4930	SCG 1093-7								

Standard color black.

*For round Mounting Hole only. For DD Mounting Hole Plug, consult Heyco.

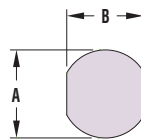
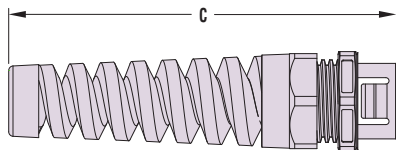

SUGGESTED CLEARANCE HOLE FOR NONTHREADED MOUNTING

- Integral nylon spring eases the cable into a lazy bend; prevents kinking and assures longest cable and product life.
- Unique fingers securely lock into a range of panel sizes without use of locknut.
- Smooth, rounded interior edges for ease of installation.
- Limited intrusion into enclosure where access is tight.
- Rotation prevented when used in Double D mounting holes.
- Easy to install—no tools required.
- Ratchet design of sealing nut assembly provides superior anti-vibration and ensures a firm grip on the cable.
- Available in multiple sizes for cable diameters ranging from .065" (1,7 mm) to .709" (18,0 mm).
- We recommend using the fitting with the smallest maximum diameter that will fit your application.
- Meet UL strain relief requirements without kinking the cable.
- For Foam Washers, see page 2-20.
- Though similar in appearance and function to Heyco-Tite Liquid Tight Cordgrips, Snap-in Cordgrip Strain Reliefs may not be liquid tight at the panel interface. For our complete range of **Liquid Tight** Cordgrips with Integral Sealing Ring, see Section 3.
- Use Heyco **Mounting Hole Plugs** for DD Mounting Holes, or **Heyco Dome Plugs** for round Mounting Holes, to fill blank/unused Mounting Holes and thus allow for a single panel design across multiple applications. See section 6.
- For Double D Mounting Hole Punches, see page 4-30.

Material
Certifications

Nylon 6/6 w/Buna N Sealing Gland
 Recognized under Underwriters' Laboratories File E51579
 Certified by Canadian Standards Association File 093876

Flammability Rating
Temperature Range

94V-2
-04°F (-18°C) to 221°F (105°C)

Quick Specs

“Stay Connected” with



Strain Relief Bushings

a PennEngineering® Company



Heyco® Snap-In Universal Strain Relief Bushings

Fit 1/2" Electrical Knock-out Hole

- **USR 400 fits the widest range of cable sizes.**
- USR 401 fits the widest range of Romex® and other **flat** cable sizes.
- Captive screw forces the locking flap against the cable.
- Captive screw meets typical European requirements wherein the Strain Relief device must remain attached to the panel during cable removal or replacement.
- Nylon USR 400 & 401 comply with:
 - IEC Publication #335
 - CEE #10 and # 11
- Easy installation: fingertip pressure locks bushing into .875" (22,2 mm) diameter holes with panel thickness up to .125" (3,2 mm).
- Reinforcing ribs for extra strength.
- Bell mouth contour, radiused at 1.5x the exit hole diameter, eliminates the need for a separate cord guard.
- Protect cables against forces of pull, push, twist, and flex.
- **For Heyco-Tite Liquid Tight Romex® Connectors, see page 3-16.**
- For Double D Mounting Hole Punches, see page 4-30.

Cross Section	WILL FIT THESE CABLES		PANEL DIMENSIONS						PART NO.	DESCRIPTION	SCREW TYPE
	Approximate Size		A		B		Panel Thickness				
	in.	mm.	in.	mm.	in.	mm.	in.	mm.			
Round or Flat	up to .360	up to 9,1	.875	22,2	.770	19,6	.062	1,6	1724	USR-400	nylon
						.125	3,2	1730			

Standard color black. Consult Heyco for white and other colors.

Heyco® Snap-In Romex® Strain Relief Bushing*

Fits 1/2" Electrical Knock-out Hole

Romex Type	AWG/ Conds	WILL FIT THESE CABLES		PANEL DIMENSIONS						PART NO.	DESCRIPTION	SCREW TYPE
		Approximate Size		A		B		Panel Thickness				
		in.	mm.	in.	mm.	in.	mm.	in.	mm.			
NM-B	14/2, 14/3, 12/2, 12/3, 10/2	up to .250 x .400	up to 6,4 x 10,2	.875	22,2	.770	19,6	.062	1,6	1726	USR-401	nylon
								.125	3,2			

Standard color black. Consult Heyco for white and other colors.

*For Romex® and other flat cables.

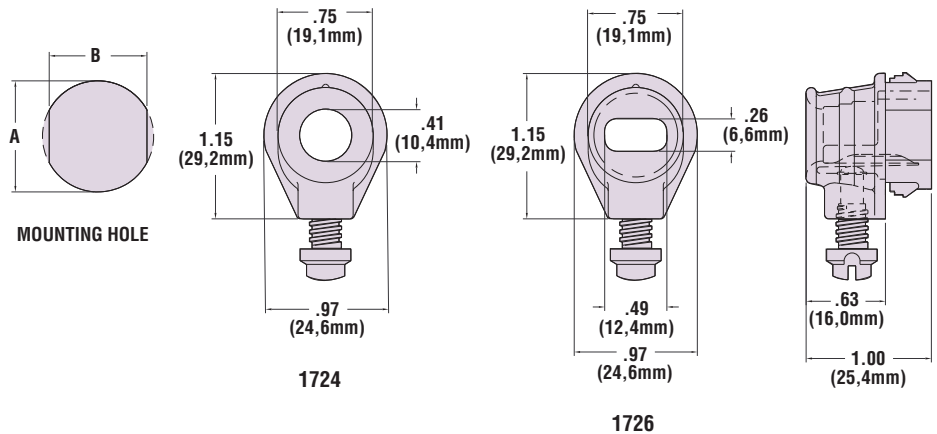

Quick Specs

Material	Nylon 6/6
Certifications	<ul style="list-style-type: none"> Recognized File E15331 for round and flat SPT type cables Listed under Underwriters' Laboratories File E103540 Certified by the Canadian Standards Association File 81067
Flammability Rating	94V-2
Temperature Range	-.04°F (-18°C) to 221°F (105°C)

Heyco® Nylon Removable Snap-In Ratcheting Strain Reliefs

For Round and Double D Mounting Holes



WILL FIT THESE CABLES Cross Section	Approximate Size		PANEL DIMENSIONS				PART NO.	DESCRIPTION	BODY LENGTH		Corresponding Mounting Hole Plug	
	in.	mm.	Mounting Hole Size in.	Mounting Hole Size mm.	Maximum Thickness in.	Maximum Thickness mm.			in.	mm.	PART NO.	DESC.
Round, Flat or Multiple	.12-.58	2,9-14,6	.875 w/.770 flats	22,2 w/19,6 flats	.13	3,2	1280	RSR 875	1.00	25,4	2509	DD 875 -770
Round, Flat or Multiple	.12-.75	2,9-19,1	1.109 w/1.000 flats	28,2 w/25,2 flats	.13	3,2	1282	RSR 1109	1.00	25,4	2717	DD 1109 -1000

Standard color black. Consult Heyco for white and other colors.

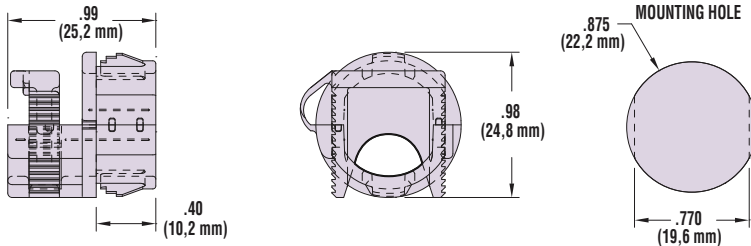
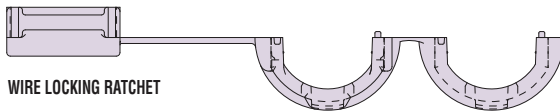
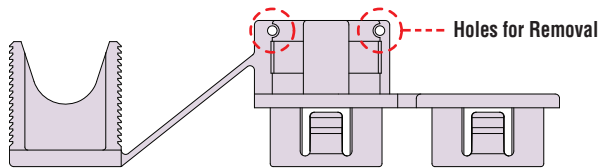

1280

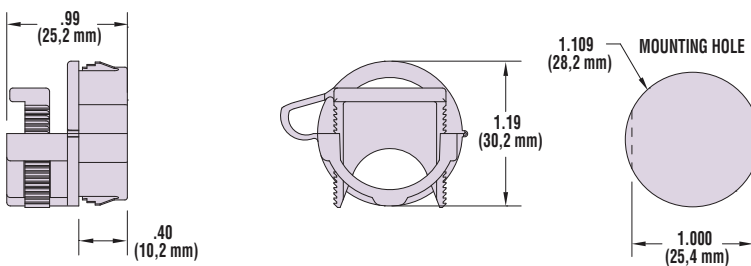

1282

- **Assembly friendly!** Independent of insertion into the panel, the Ratcheting Strain Relief **self-locks** onto the cable. Thus, it may be preassembled offline for final assembly at a later time or remote location, for lower installed cost!
- Unique wire locking ratchet allows for generous wire range from .12" (2,9 mm) to .75" (19,1 mm).
- Can be used for one cable or multiple cables (round or flat wire).
- Installs easily with fingertip pressure into a standard round or Double D hole.
- Ratcheting Strain Relief can be easily removed by inserting standard snap ring pliers with .04" tips (Heyco PN 0054) into the two holes on the part (see drawing) and spreading part open.
- Ideal solution for managing internal wire bundles such as wire harnesses.
- PN 1280 UL Recognized for multiple cables/conductors.
- Consult Heyco for other wire types and sizes.
- For Double D Mounting Hole Punches, see page 4-30.

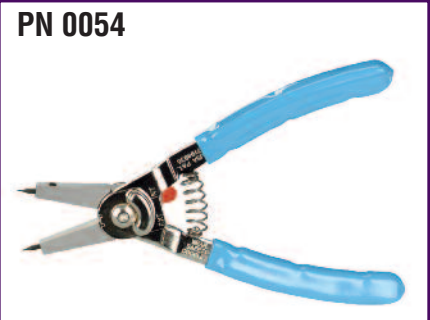

PN 0054

Material	Nylon 6/6
Certifications	Recognized under the Component Program of Underwriters' Laboratories File E15331 Certified by Canadian Standards Association File 8919
Flammability Rating	94V-2
Temperature Range	-.04°F (-18°C) to 221°F (105°C)

Quick Specs



Heyco® ST Lockit™ Strain Relief Bushings

Snap onto **Round Cables** for Faster Assembly into **Rectangular Mounting Holes** – *Semi-Automatic Equipment Available*

- **Assembly friendly!** Independent of insertion into the panel, Lockit Strain Reliefs **self-lock** onto the cable. Preassemble off line for final assembly at a later time or remote location, for lower installed cost!
- Lockit Strain Reliefs hold so well they pass the UL pull-out test requirements with or without panel support.
- Protect the lifeline of your electric/electronic products by absorbing the forces of push and pull that may be exerted on the flexible power cord. Rectangular design eliminates the possibility of part rotation under forces of twist.
- Lockit’s three finger design securely anchors into panels as thin as .032” (0,8 mm) and as thick as .157” (4,0 mm) for a neat, clean appearance. Five locking steps accommodate a wide range of panel thicknesses. Low profile head satisfies design aesthetics!
- Heyco’s automated Pre-Assembly Equipment speeds assembly of the Lockit onto the cable and thus lowers costs while greatly reducing risk of carpal tunnel syndrome. See pages 4-15 & 4-16.
- Consult Heyco for other wire types and sizes.
- See page 4-38 for corresponding **Mounting Hole Plugs** which can be used to fill blank/unused Mounting Holes and thus allow for a single panel design for multiple applications.

UL Type	WILL FIT THESE CABLES		PANEL DIMENSIONS				ST LOCKIT STRAIN RELIEF for Faster Assembly		Corresponding Mounting Hole Plug	
	AWG/ Conductors	Approximate Size in. mm.	Mounting Hole Size in. mm.		Thickness in. mm.		Black	White	PART NO.	DESC.
See table on page 4-10	various	.220 - .290 5,6 - 7,4	.453 x .512	11,5 x 13,0	.032 .040 .048 .063 .099	0,8 1,1 1,2 1,6 2,5	1832	1833	ST 101N	1890 RP 115-130
See table on page 4-10	various	.290 - .360 7,4 - 9,1	.689 x .689	17,5 x 17,5	.032 .063 .099 .126 .157	0,8 1,6 2,5 3,2 4,0	1836	1837	ST 201N	1892 RP 175-175
See table on page 4-10	various	.355 - .420 9,0 - 10,6	.689 x .689	17,5 x 17,5	.032 .063 .099 .126 .157	0,8 1,6 2,5 3,2 4,0	1848	1849	ST 301N	1892 RP 175-175

Standard color black. Consult Heyco for white and other colors.

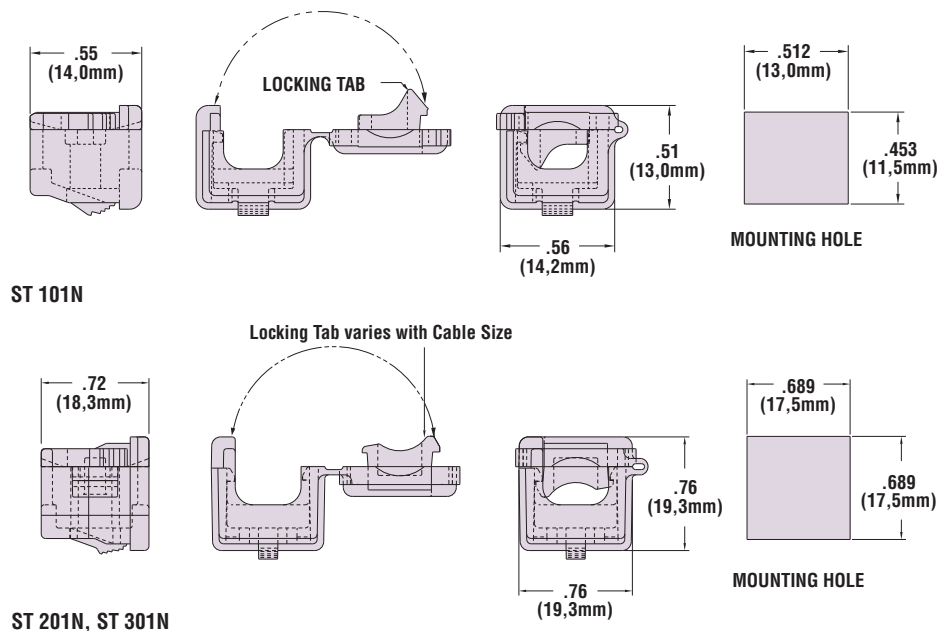

Quick
Specs

Material
Certifications

Nylon 6/6

Recognized under the Component Program of Underwriters' Laboratories File E15331

Certified by the Canadian Standards Association File 8919

Flammability Rating
Temperature Range

94V-2

-.04°F (-18°C) to 221°F (105°C).

“Stay Connected” with



Strain Relief Bushings

a PennEngineering® Company

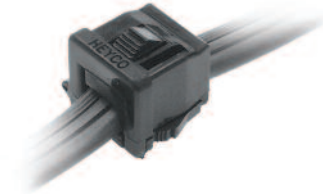

Heyco® ST Lockit™ Strain Relief Bushings

Snap onto **Flat Cables** for Faster Assembly into **Rectangular Mounting Holes** – *Semi-Automatic Equipment Available*

UL Type	WILL FIT THESE CABLES		PANEL DIMENSIONS				ST LOCKIT STRAIN RELIEF for Faster Assembly			Corresponding Mounting Hole Plug		
	AWG/Conductors	Approximate Size in. mm.	Mounting Hole Size in. mm.		Thickness in. mm.		Black	White	DESC.	PART NO.	DESC.	
SPT-3	16/3	.03 x .10	0,8 x 2,5	.453 x .630	11,5 x 16,0	.032	0,8	1847	1846	ST 100L	-	consult Heyco
HPN	18/3	.11 x .38	2,7 x 9,7			.040	1,1					
SPT-2	18/2	.14 x .27	3,3 x 6,9			.063	1,6					
SPT-1	18/2	.12 x .22	3,0 x 5,6	.453 x .512	11,5 x 13,0	.032	0,8	1829	1830	ST 100N	1890	RP 115-130
	18/3	.12 x .30	3,0 x 7,6			.040	1,1					
SPT-2 & HPN	18/2	.15 x .28	3,8 x 7,1	.689 x .689	17,5 x 17,5	.048	1,2	1834	1835	ST 200N	1892	RP 175-175
	16/2	.16 x .30	4,1 x 7,6			.063	1,6					
HPN	16/3	.16 x .37	4,1 x 9,4	.689 x .689	17,5 x 17,5	.099	2,5	1834	1835	ST 200N	1892	RP 175-175
	18/3	.15 x .34	3,8 x 8,6			.126	3,2					
SPT-2	16/3	.16 x .41	4,1 x 10,4	.689 x .689	17,5 x 17,5	.157	4,0	1834	1835	ST 200N	1892	RP 175-175
	18/2	.19 x .35	4,8 x 8,9									
SPT-3	18/3	.19 x .39	4,8 x 9,9	.689 x .689	17,5 x 17,5			1834	1835	ST 200N	1892	RP 175-175
	16/2	.20 x .37	5,1 x 9,4									
	16/3	.20 x .43	5,1 x 10,9									
	14/2	.24 x .42	6,1 x 10,7									

Standard color black. Consult Heyco for white and other colors.

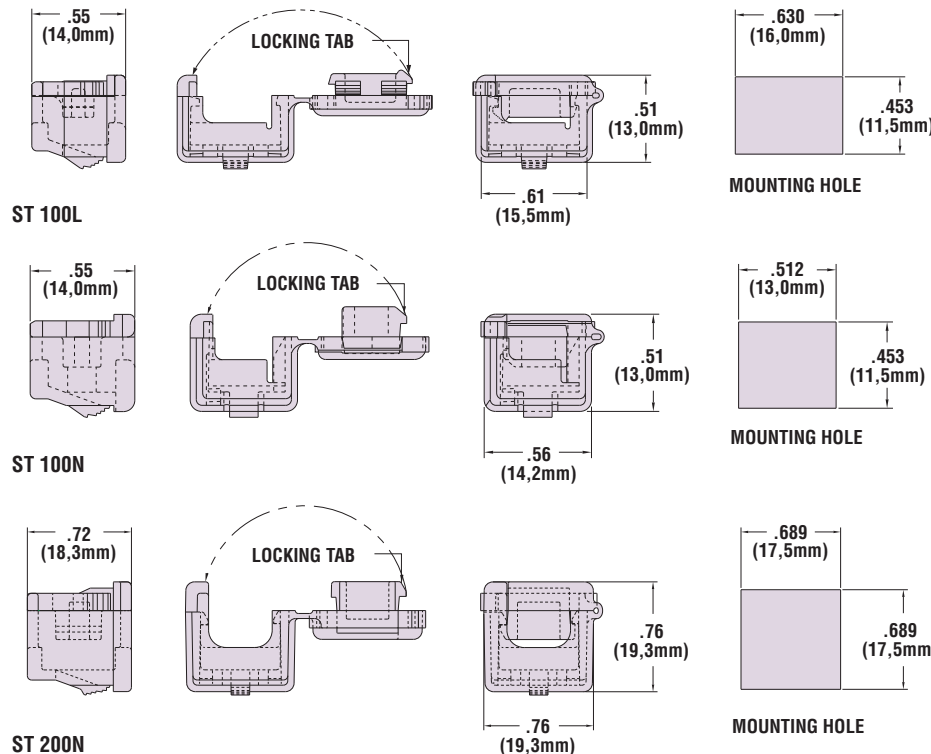

- **Assembly friendly!** Independent of insertion into the panel, Lockit Strain Reliefs **self-lock** onto the cable. Preassemble off line for final assembly at a later time or remote location, for lower installed cost!
- Lockit Strain Reliefs hold so well they pass the UL pullout test requirements with or without panel support.
- Protect the lifeline of your electric/electronic products by absorbing the forces of push and pull that may be exerted on the flexible power cord. Rectangular design eliminates the possibility of part rotation under forces of twist.
- Lockit's three finger design securely anchors into panels as thin as .032" (0,8 mm) and as thick as .157" (4,0 mm) for a neat, clean appearance. Five locking steps accommodate a wide range of panel thickness. Low profile head satisfies design aesthetics!
- Heyco's automated Pre-Assembly Equipment speeds assembly of the Lockit onto the cable and thus lowers costs while greatly reducing risk of carpal tunnel syndrome. See pages 4-15 & 4-16.
- Consult Heyco for other wire types and sizes.
- See page 4-38 for corresponding **Mounting Hole Plugs** which can be used to fill blank/unused Mounting Holes and thus allow for a single panel design for multiple applications.
- **For Quick Specs see page 4-5.**



Heyco® RDD Lockit™ Strain Relief Bushings – Straight-Thru

Snap onto **Round Cables** for Faster Assembly into **Double D Mounting Holes** – *Semi-Automatic Equipment Available*

- **Assembly friendly!** Independent of insertion into the panel, RDD Lockit™ Strain Reliefs **self-lock** onto the cable. Preassemble RDD Lockits off line for final assembly at a later time or remote location, for lower installed cost!
- Install easily with fingertip pressure into a standard round or Double D hole. No tools required, even for hand assembly.
- Protect the lifeline of your electric/electronic products by absorbing the forces of push and pull that may be exerted on the flexible power cord. Double D design eliminates the possibility of part rotation under forces of twist.
- Multiple panel locking steps secure Lockit Strain Reliefs into a wide range of panel thicknesses for a **flush, finished fit**.
- Heyco's automated Pre-Assembly Equipment speeds assembly of the RDD onto the cable and thus lowers costs while greatly reducing risk of carpal tunnel syndrome. See pages 4-15 & 4-16.
- Consult Heyco for other wire types and sizes.
- See page 4-38 for corresponding **Mounting Hole Plugs** which can be used to fill blank/unused Mounting Holes and thus allow for a single panel design for multiple applications.
- For Double D Mounting Hole Punches, see page 4-30.

UL Type	WILL FIT THESE CABLES		PANEL DIMENSIONS				RDD LOCKIT STRAIN RELIEF for Faster Assembly			Corresponding Mounting Hole Plug		
	AWG/Conductors	Approximate Size	Mounting Hole Size		Thickness		Black	White	DESC.	PART NO.	DESC.	
AWN SJTO & SJ	18/3	.130- .210	3,3- 5,3	.625 w/ .550 flats	15,9 w/ 14,0 flats	.032 .040 .048 .063 .099	0,8 1,1 1,2 1,6 2,5	1870	1871	RDD 101-A	2497	DD 625-550
See table on page 4-10	various	.220- .290	5,6- 7,4	.625 w/ .550 flats	15,9 w/ 14,0 flats	.032 .040 .048 .063 .099	0,8 1,1 1,2 1,6 2,5	1852	1853	RDD 101	2497	DD 625-550
SJT SJO	18/3	.300- .330	7,6- 8,4	.625 w/ .550 flats	15,9 w/ 14,0 flats	.062	1,6	1800	1801	RDD 6N-2	2497	DD 625-550

Standard color black. Consult Heyco for white and other colors.

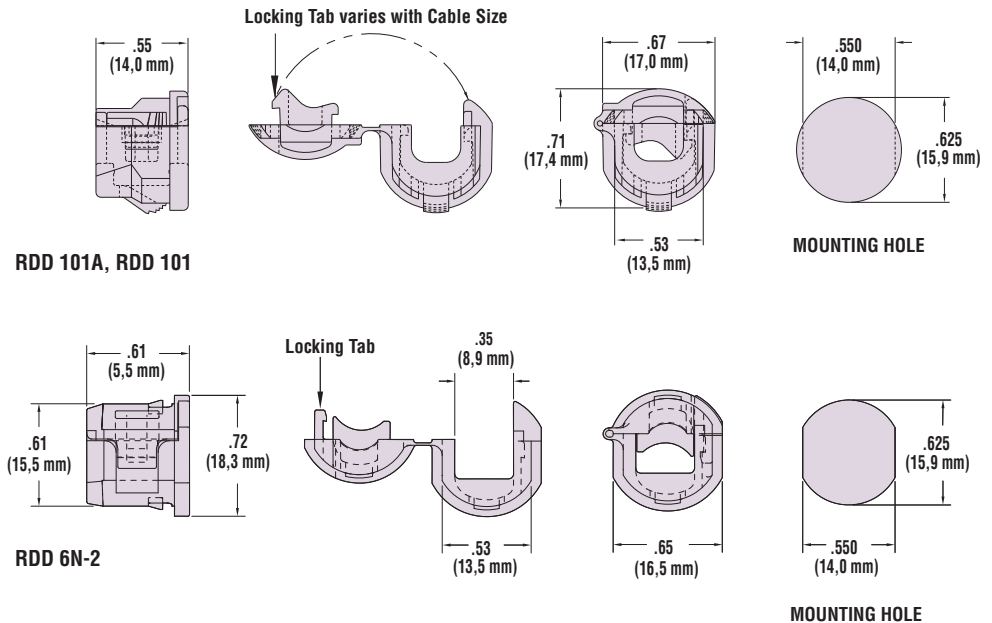

Quick Specs

Material
Certifications

Nylon 6/6

Recognized under UL File E15331

Certified by the Canadian Standards Association File 8919

Flammability Rating
Temperature Range

94V-2

-.04°F (-18°C) to 221°F (105°C)

“Stay Connected” with



Strain Relief Bushings

a PennEngineering® Company

Heyco® RDD Lockit™ Strain Relief Bushings – Straight-Thru

Snap onto **Round Cables** for Faster Assembly into **Double D Mounting Holes** – *Semi-Automatic Equipment Available*
Fit 1/2" Electrical Knock-out Hole



UL Type	WILL FIT THESE CABLES		PANEL DIMENSIONS				RDD LOCKIT STRAIN RELIEF for Faster Assembly			Corresponding Mounting Hole Plug		
	AWG/Conductors	Approximate Size	Mounting Hole Size		Thickness		Black	White	DESC.	PART NO.	DESC.	
		in.	mm.	in.	mm.	in.	mm.					
See table on page 4-10	various	.290-.385	7,4-9,8	.875 w/.770 flats	22,2 w/19,6 flats	.032	0,8	1857	1858	RDD 201	2509	DD 875-770
						.063	1,6					
						.099	2,5					
						.126	3,2					
						.157	4,0					
Same as RDD 201 above except →						.078	2,0	1855	1856	RDD 201-2*	2509	DD 875-770
See table on page 4-10	various	.340-.430	8,6-10,9	.875 w/.770 flats	22,2 w/19,6 flats	.032	0,8	1861	1862	RDD 301	2509	DD 875-770
						.063	1,6					
						.099	2,5					
						.126	3,2					
						.157	4,0					
Same as RDD 301 above except →						.078	2,0	1859	1860	RDD 301-2*	2509	DD 875-770
See table on page 4-10	various	.420-.450	10,7-11,4	.875 w/.770 flats	22,2 w/19,6 flats	.032	0,8	1865	1866	RDD 401	2509	DD 875-770
						.063	1,6					
						.099	2,5					
						.126	3,2					
						.157	4,0					
Same as RDD 401 above except →						.078	2,0	1882	1883	RDD 401-2*	2509	DD 875-770

Standard color black. Consult Heyco for white and other colors.
*Designed for cast or other mounting holes with rounded edges.

- **Assembly friendly!** Independent of insertion into the panel, RDD Lockit™ Strain Reliefs **self-lock** onto the cable. Preassemble RDD Lockits off line for final assembly at a later time or remote location, for lower installed cost!
- Install easily with fingertip pressure into a standard round or Double D hole. No tools required, even for hand assembly.
- Protect the lifeline of your electric/electronic products by absorbing the forces of push and pull that may be exerted on the flexible power cord. Double D design eliminates the possibility of part rotation under forces of twist.
- Multiple panel locking steps secure Lockit Strain Reliefs into a wide range of panel thicknesses for a **flush, finished fit**.
- Heyco’s automated Pre-Assembly Equipment speeds assembly of the RDD onto the cable and thus lowers costs while greatly reducing risk of carpal tunnel syndrome. See pages 4-15 & 4-16.
- Consult Heyco for other wire types and sizes.
- See page 4-38 for corresponding **Mounting Hole Plugs** which can be used to fill blank/unused Mounting Holes and thus allow for a single panel design for multiple applications.
- For Double D Mounting Hole Punches, see page 4-30.

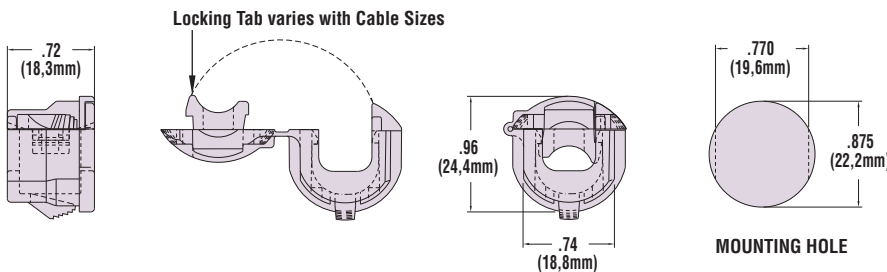

RDD 201, RDD 201-2, RDD 301, RDD 301-2, RDD 401, RDD 401-2

Material	Nylon 6/6
Certifications	Recognized under UL File E15331 Certified by the Canadian Standards Association File 8919
Flammability Rating	94V-2
Temperature Range	-04°F (-18°C) to 221°F (105°C)

Quick Specs



Heyco® RDD Lockit™ Strain Relief Bushings – Straight-Thru

Snap onto **Round Cables** for Faster Assembly into **Double D Mounting Holes** – *Semi-Automatic Equipment Available*
Fit 3/4" Electrical Knock-out Hole

- **Assembly friendly!** Independent of insertion into the panel, RDD Lockit™ Strain Reliefs **self-lock** onto the cable. Preassemble RDD Lockits off line for final assembly at a later time or remote location, for lower installed cost!
- Install easily with fingertip pressure into a standard round or Double D hole. No tools required, even for hand assembly.
- Protect the lifeline of your electric/electronic products by absorbing the forces of push and pull that may be exerted on the flexible power cord. Double D design eliminates the possibility of part rotation under forces of twist.
- Multiple panel locking steps secure Lockit Strain Reliefs into a wide range of panel thicknesses for a **flush, finished fit**.
- Heyco's automated Pre-Assembly Equipment speeds assembly of the RDD onto the cable and thus lowers costs while greatly reducing risk of carpal tunnel syndrome. See pages 4-15 & 4-16.
- Consult Heyco for other wire types and sizes.
- See page 4-38 for corresponding **Mounting Hole Plugs** which can be used to fill blank/unused Mounting Holes and thus allow for a single panel design for multiple applications.
- For Double D Mounting Hole Punches, see page 4-30.

WILL FIT THESE CABLES				PANEL DIMENSIONS				RDD LOCKIT STRAIN RELIEF for Faster Assembly			Corresponding Mounting Hole Plug	
UL Type	AWG/ Conductors	Approximate Size		Mounting Hole Size		Thickness		PART NO. Black	PART NO. White	DESC.	PART NO.	DESC.
		in.	mm.	in.	mm.	in.	mm.					
See table on page 4-10	various	.525-.600	13.5-15.2	1.109 w/ 1.000 flats	28.2 w/ 25.4 flats	.063	1.6	1868	1869	RDD 501	2717	DD 1109-1000
						.099	2.5					
						.126	3.2					
						.157	4.0					
						.187	4.8					
See table on page 4-10	various	.600-.700	15.2-17.8	1.109 w/ 1.000 flats	28.2 w/ 25.4 flats	.063	1.6	1802	1803	RDD 601		
						.099	2.5					
						.126	3.2					
						.157	4.0					
						.187	4.8					
See table on page 4-10	various	.720-.830	18.3-21.1	1.250 w/ 1.125 flats	31.8 w/ 28.6 flats	.063	1.6	1880	1881	RDD 701		consult Heyco NEW!
						.099	2.5					
						.126	3.2					
						.157	4.0					
						.187	4.8					

Standard color black. Consult Heyco for white and other colors.

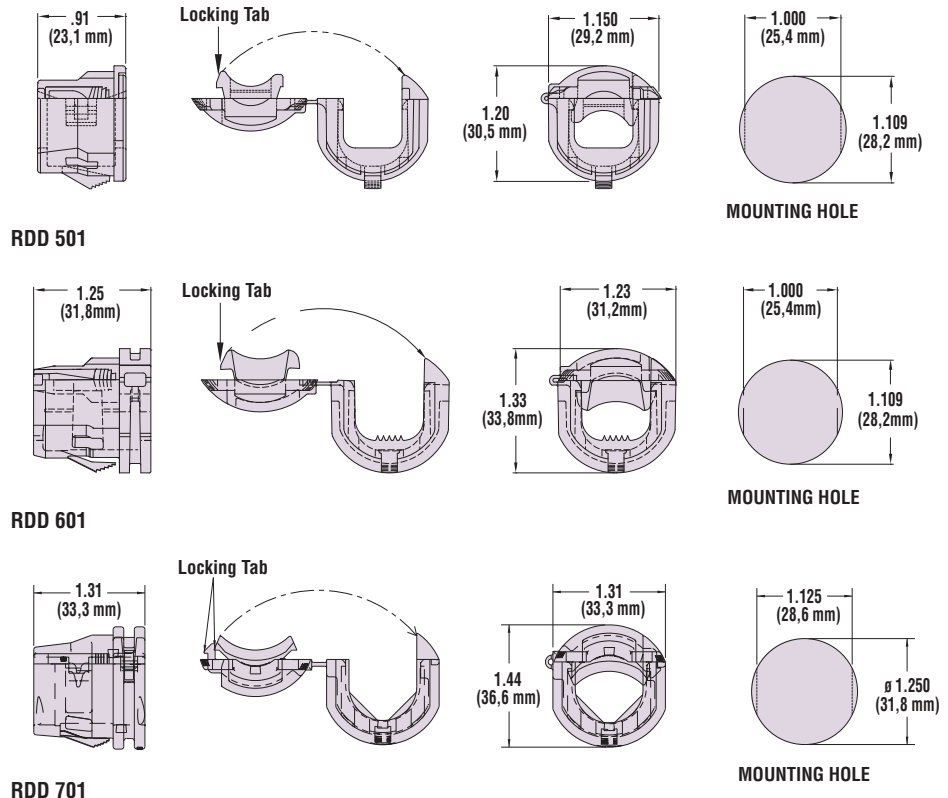

Quick Specs

Material	Nylon 6/6
Certifications	Recognized under UL File E15331 Certified by the Canadian Standards Association File 8919
Flammability Rating	94V-2
Temperature Range	-.04°F (-18°C) to 221°F (105°C)

“Stay Connected” with



Strain Relief Bushings

a PennEngineering® Company

Heyco® Lockit™ ST and RDD Strain Relief Bushings

Table of UL Recognized Round Wire Types

Lockit™ Strain Reliefs for Round Cables										
Mounting Hole Diameter →	UL Approved for Cable Diameter Range			UL Approved for Cable Diameter Range and UL Type						
	11,5 x 13,0 mm	17,5 x 17,5 mm		.625" (15,9 mm) Ø	Will Fit Electrical Knock-outs			1.109" (28,2 mm) Ø		1.250" (31,8 mm) Ø
LOCKIT Variety	ST 101N	ST 201N	ST 301N	RDD 101 RDD 101-7 RDD 101-90	RDD 201 RDD 201-2 RDD 201-90	RDD 301 RDD 301-2 RDD 301-90	RDD 401 RDD 401-2	RDD 501	RDD 601	RDD 701
UL DIA. RANGE	.220" - .290"	.290" - .360"	.355" - .420"	.220" - .290" 5,6 - 7,4 mm	.290" - .385" 7,4 - 9,8 mm	.340" - .430" 8,6 - 10,9 mm	.420" - .450"	.525" - .600"	.600" - .700"	.720" - .830"
UL TYPE										
S	X	X	X	X	X	X	X	X	X	X
SE	X	X	X	X	X	X	X	X	X	X
SEO	X	X	X	X	X	X	X	X	X	X
SE00									X	
SE00W	X	X	X	X	X	X	X		X	X
SE0W	X	X	X	X	X	X	X		X	X
SJ	X	X	X	X	X	X	X	X	X	
SJE								X		
SJE00W	X	X	X	X	X	X	X			
SJE0W	X	X	X	X	X	X	X			
SJO	X	X	X	X	X	X	X	X	X	
SJ00	X	X	X	X	X	X	X	X	X	X
SJ00W	X	X	X	X	X	X	X			
SJ0W	X	X	X	X	X	X	X			
SJT								X	X	
SJTE00W	X	X	X	X	X	X	X			
SJTE0W	X	X	X	X	X	X	X			
SJTO	X	X	X	X	X	X	X	X		
SJT00	X	X	X	X	X	X	X	X		
SJT00W	X	X	X	X	X	X	X			
SJT0W	X	X	X	X	X	X	X			
SJTW	X	X	X	X	X	X	X			
SO	X	X	X	X	X	X	X	X	X	X
SO0	X	X	X	X	X	X	X	X	X	X
SO0W	X	X	X	X	X	X	X			X
SOW	X	X	X	X	X	X	X			X
SRDT									X	
ST									X	
ST0								X	X	
ST00								X	X	
ST00W									X	
ST0W									X	
SV	X	X	X	X	X	X	X			X
SVE	X	X	X	X	X	X	X			X
SVE0	X	X	X	X	X	X	X			X
SVE0	X	X	X	X	X	X	X			X
SVO	X	X	X	X	X	X	X			X
SVO0	X	X	X	X	X	X	X			X

Consult Heyco for UL Type designations not shown.

“Stay Connected” with



Strain Relief Bushings

a PennEngineering® Company



Heyco® RDD Lockit™ Strain Relief Bushings – Straight-Thru

Snap onto **Flat Cables** for Faster Assembly into **Double D Mounting Holes** – *Semi-Automatic Equipment Available*

- **Assembly friendly!** Independent of insertion into the panel, RDD Lockit™ Strain Reliefs **self-lock** onto the cable. Preassemble RDD Lockits off line for final assembly at a later time or remote location, for lower installed cost!
- Install easily with fingertip pressure into a standard round or Double D hole. No tools required, even for hand assembly.
- Protect the lifeline of your electric/electronic products by absorbing the forces of push and pull that may be exerted on the flexible power cord. Double D design eliminates the possibility of part rotation under forces of twist.
- Multiple panel locking steps secure Lockit Strain Reliefs into a wide range of panel thicknesses for a **flush, finished fit**.
- Heyco’s automated Pre-Assembly Equipment speeds assembly of the RDD onto the cable and thus lowers costs while greatly reducing risk of carpal tunnel syndrome. See pages 4-15 & 4-16.
- Consult Heyco for other wire types and sizes.
- See page 4-38 for corresponding **Mounting Hole Plugs** which can be used to fill blank/unused Mounting Holes and thus allow for a single panel design for multiple applications.
- **For Quick Specs see page 4-12.**
- For Double D Mounting Hole Punches, see page 4-30.

UL Type	WILL FIT THESE CABLES		PANEL DIMENSIONS				RDD LOCKIT STRAIN RELIEF for Faster Assembly		Corresponding Mounting Hole Plug			
	AWG/Conductors	Approximate Size in. mm.	Mounting Hole Size in. mm.		Thickness in. mm.		Black	White	PART NO.	DESC.		
SPT-1	18/2 18/3	.105 x .222 .116 x .315	2,7 x 5,6 2,9 x 8,0	.625 w/ .550 flats	15,9 w/ 14,0 flats	.032	0,8	1872	1873	RDD 100A	2497	DD 625-550
						.040	1,0					
						.048	1,2					
						.063	1,6					
						.099	2,5					
SPT-2, HPN	18/2 18/3 16/3	.116 x .315 .160 x .300	2,9 x 8,0 4,1 x 7,6	.625 w/ .550 flats	15,9 w/ 14,0 flats	.032	0,8	1874	1875	RDD 100	2497	DD 625-550
						.040	1,0					
						.048	1,2					
						.063	1,6					
						.099	2,5					
HPN	18/3 16/3	.15 x .34 .16 x .37	3,8 x 8,6 4,1 x 9,4									
SPT-2	18/3 16/3	.15 x .40 .16 x .41	3,8 x 10,2 4,1 x 10,4			.032	0,8					
						.063	1,6					
SPT-3	18/2 18/3 16/2 16/3 14/2	.19 x .35 .19 x .39 .20 x .37 .20 x .43 .24 x .42	4,8 x 8,9 4,8 x 9,9 5,1 x 9,4 5,1 x 10,9 6,1 x 10,7	.875 w/ .770 flats	22,2 w/ 19,6 flats	.032	0,8	1878	1879	RDD 200	2509	DD 875-770
						.063	1,6					
						.099	2,5					
						.126	3,2					
						.157	4,0					
Same as RDD 200 above except →						.078	2,0	1876	1877	RDD 200-2*	2509	DD 875-770
						.140	3,4					
Same as RDD 200 above except →				1.109 w/ 1.006 flats	28,2 w/ 25,4 flats	.063	1,6	1798	1799	RDD 510	2717	DD 1109-1000
						.099	2,5					
						.126	3,2					
						.157	4,0					
						.187	4,8					

Standard color black. Consult Heyco for white and other colors.
*Designed for cast or other mounting holes with rounded edges.

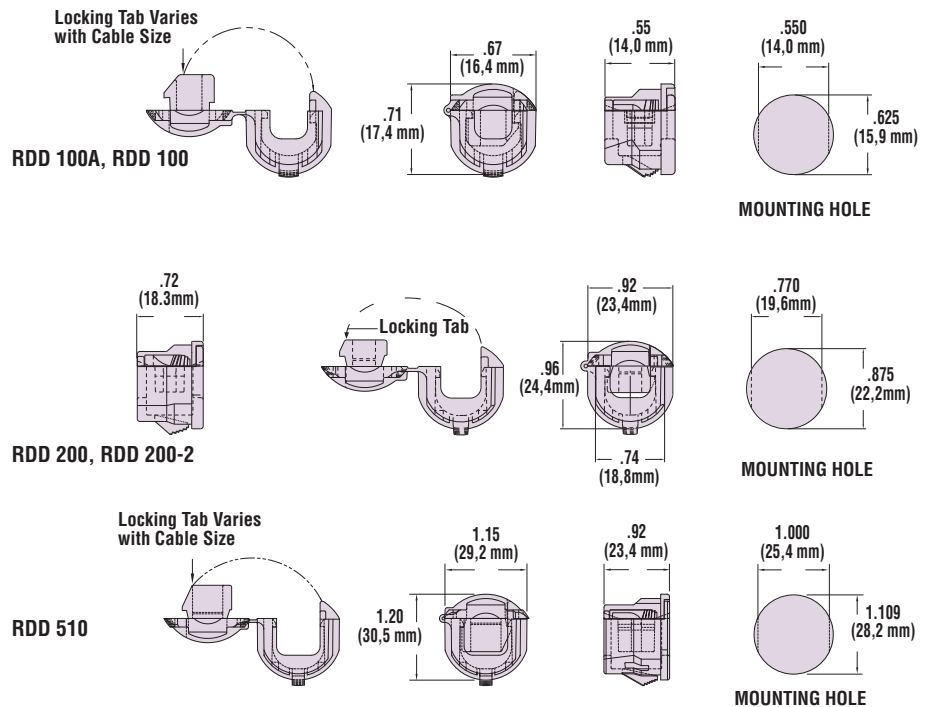

“Stay Connected” with



Strain Relief Bushings

a PennEngineering® Company



Heyco® RDD Lockit™ Strain Relief Bushings – Pigtail™

Snap onto **Flat or Round Cables** for Faster Assembly into **Double D Mounting Holes** – *Semi-Automatic Equipment Available*

UL Type	WILL FIT THESE CABLES		PANEL DIMENSIONS				RDD LOCKIT STRAIN RELIEF for Faster Assembly			Corresponding Mounting Hole Plug		
	AWG/ Conductors	Approximate Size	Mounting Hole Size		Thickness		Black	White	DESC.	PART NO.	DESC.	
		in. mm.	in. mm.	in. mm.	in. mm.	in. mm.						
For Flat Cables												
SPT-1	18/2	.105 x .222	2,7 x 5,6	.625 w/ .550 flats	15,9 w/ 14,0 flats	.032	0,8	1769	1770	RDD 100A-7	2497	DD 625-550
	18/3	.116 x .315	2,9 x 8,0			.040	1,1					
						.048	1,2					
						.063	1,6					
						.099	2,5					
SPT-2, HPN	18/2	.116 x .315	2,9 x 8,0	.625 w/ .550 flats	15,9 w/ 14,0 flats	.032	0,8	1771	1772	RDD 100-7	2497	DD 625-550
	18/3	.160 x .300	4,1 x 7,6			.040	1,1					
	16/3					.048	1,2					
						.063	1,6					
						.099	2,5					
For Round Cables												
See table on page 4-10	various	.220-.290	5,6 x 7,4	.625 w/ .550 flats	15,9 w/ 14,0 flats	.032	0,8	1773	1774	RDD 101-7	2497	DD 625-550
						.040	1,1					
						.048	1,2					
						.063	1,6					
						.099	2,5					

Standard color black. Consult Heyco for white and other colors.

- **Integral nylon spring eases the cable into a lazy bend**; prevents kinking and assures longest cable and product life.
- Designed to pass CSA's 50,000 cycle vacuum cleaner test (C22.2 No. 67) and UL's 859 specification for Household Electric Personal Grooming Appliances Cord Flexing Test.
- Assembly friendly! Independent of insertion into the panel, RDD Lockit™ Strain Reliefs self-lock onto the cable. Preassemble RDD Lockits off line for final assembly at a later time or remote location, for lower installed cost!
- Install easily with fingertip pressure into a standard round or Double D hole. No tools required, even for hand assembly.
- Protect the lifeline of your electric/ electronic products by absorbing the forces of push and pull that may be exerted on the flexible power cord. Double D design eliminates the possibility of part rotation under forces of twist.
- Multiple panel locking steps secure Lockit Strain Reliefs into a wide range of panel thicknesses for a **flush, finished fit**.
- Heyco's automated Pre-Assembly Equipment speeds assembly of the RDD onto the cable and thus lowers costs while greatly reducing risk of carpal tunnel syndrome. See pages 4-15 & 4-16.
- See page 4-38 for corresponding **Mounting Hole Plugs** which can be used to fill blank/unused Mounting Holes and thus allow for a single panel design for multiple applications.
- For Double D Mounting Hole Punches, see page 4-30.

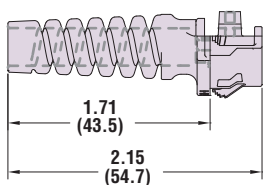

RDD 100A-7, RDD 100-7, RDD 101-7

Locking Tab varies with Cable Type

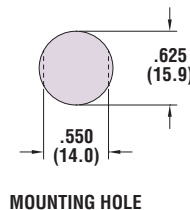
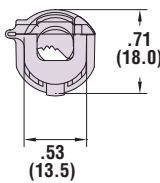
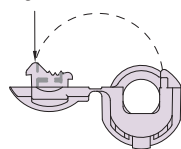

MOUNTING HOLE

Material	Nylon 6/6
Certifications	Recognized under the Component Program of Underwriters' Laboratories File E15331 Certified by the Canadian Standards Association File 8919
Flammability Rating	94V-2
Temperature Range	-04°F (-18°C) to 221°F (105°C)

Quick Specs

“Stay Connected” with



Strain Relief Bushings

a PennEngineering® Company



Heyco® RDD Lockit™ Strain Relief Bushings – Right Angle

Snap onto **Round Cables** for Faster Assembly into **Double D Mounting Holes** – *Semi-Automatic Equipment Available*

- **Right Angle design eases the cable into the bend**, prevents kinking and assures longest cable and product life.
- Assembly friendly! Independent of insertion into the panel, RDD Lockit™ Strain Reliefs self-lock onto the cable. Preassemble RDD Lockits off line for final assembly at a later time or remote location, for lower installed cost!
- Install easily with fingertip pressure into a standard round or Double D hole. No tools required, even for hand assembly.
- Protect the lifeline of your electric/electronic products by absorbing the forces of push and pull that may be exerted on the flexible power cord. Double D design eliminates the possibility of part rotation under forces of twist.
- Multiple panel locking steps secure Lockit Strain Reliefs into a wide range of panel thicknesses for a **flush, finished fit**.
- Heyco’s automated Pre-Assembly Equipment speeds assembly of the RDD onto the cable and thus lowers costs while greatly reducing risk of carpal tunnel syndrome. See pages 4-15 & 4-16.
- Consult Heyco for other wire types and sizes.
- See page 4-38 for corresponding **Mounting Hole Plugs** which can be used to fill blank/unused Mounting Holes and thus allow for a single panel design for multiple applications.
- For Double D Mounting Hole Punches, see page 4-30.

UL Type	WILL FIT THESE CABLES			PANEL DIMENSIONS				RDD LOCKIT STRAIN RELIEF for Faster Assembly			Corresponding Mounting Hole Plug	
	AWG/Conductors	Approximate Size		Mounting Hole Size		Thickness		PART NO. Black	PART NO. White	DESC.	PART NO.	DESC.
		in.	mm.	in.	mm.	in.	mm.					
AWM, SJTO & SJ	18/3	.130-.210	3.3-5.3	.625 w/ .550 flats	15.9 w/ 14.0 flats	.032 .040 .048 .063 .099	0.8 1.1 1.2 1.6 2.5	1816	1817	RDD 101A-90	2497	DD 625-550
See table on page 4-10	various	.220-.290	5.6-7.4	.625 w/ .550 flats	15.9 w/ 14.0 flats	.032 .040 .048 .063 .099	0.8 1.1 1.2 1.6 2.5	1818	1819	RDD 101-90	2497	DD 625-550
See table on page 4-10	various	.290-.385	7.4-9.8	.875 w/ .770 flats	22.2 w/ 19.6 flats	.032 .063 .099 .126 .157	0.8 1.6 2.5 3.2 4.0	1820	1821	RDD 201-90	2509	DD 875-770
See table on page 4-10	various	.340-.430	8.6-10.9	.875 w/ .770 flats	22.2 w/ 19.6 flats	.032 .063 .099 .126 .157	0.8 1.6 2.5 3.2 4.0	1824	1825	RDD 301-90	2509	DD 875-770

Standard color black. Consult Heyco for white and other colors.

Locking Tab varies with cable size

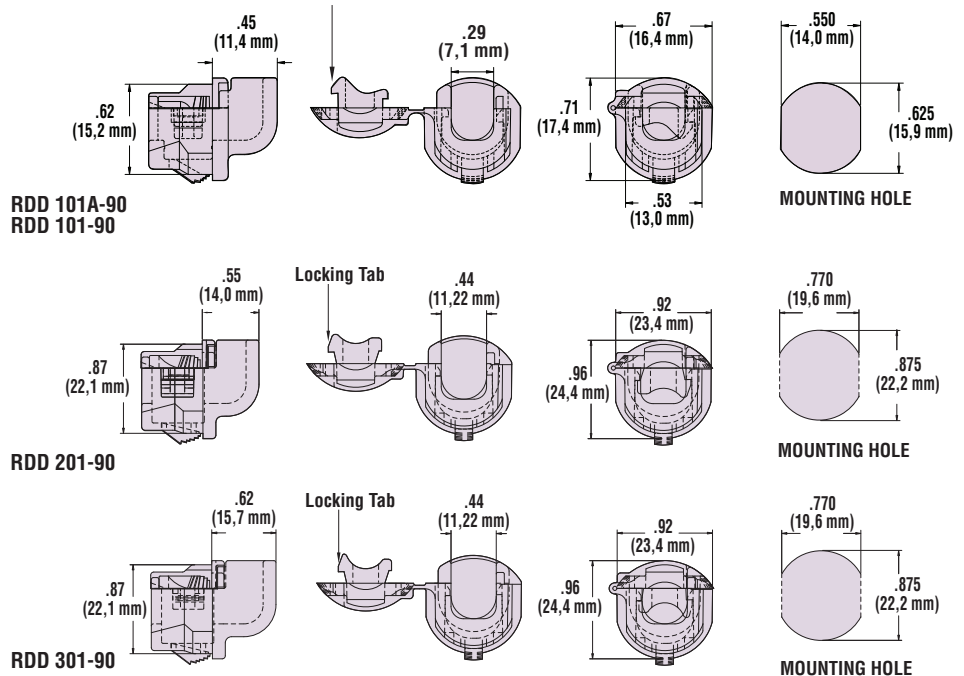

Quick Specs

Material	Nylon 6/6
Certifications	Recognized under the Component Program of Underwriters' Laboratories File E15331
	Certified by the Canadian Standards Association File 8919
Flammability Rating	94V-2
Temperature Range	-04°F (-18°C) to 221°F (105°C).

“Stay Connected” with



Strain Relief Bushings

a PennEngineering® Company

Heyco® RDD Lockit™ Strain Relief Bushings – Right Angle

Snap onto **Flat Cables** for Faster Assembly into **Double D Mounting Holes** – *Semi-Automatic Equipment Available*



UL Type	WILL FIT THESE CABLES		PANEL DIMENSIONS				RDD LOCKIT STRAIN RELIEF for Faster Assembly			Corresponding Mounting Hole Plug		
	AWG/ Conductors	Approximate Size	Mounting Hole Size		Thickness		Black	White	DESC.	PART NO.	DESC.	
		in.	mm.	in.	mm.	in.	mm.					
SPT-1	18/2 18/3	.105 x .222 .116 x .315	2,7 x 5,6 2,9 x 8,0	.625 w/ .550 flats	15,9 w/ 14,0 flats	.032	0,8	1806	1807	RDD 100A-90	2497	DD 625-550
						.040	1,1					
						.048	1,2					
						.063	1,6					
						.099	2,5					
SPT-2, HPN	18/2 18/3 16/3	.116 x .315 .160 x .300	2,9 x 8,0 4,1 x 7,6	.625 w/ .550 flats	15,9 w/ 14,0 flats	.032	0,8	1808	1809	RDD 100-90	2497	DD 625-550
						.040	1,1					
						.048	1,2					
						.063	1,6					
						.099	2,5					
HPN	18/3 16/3	.15 x .34 .16 x .37	3,8 x 8,6 4,1 x 9,4									
SPT-2	18/3 16/3	.15 x .40 .16 x .41	3,8 x 10,2 4,1 x 10,4	.875 w/ .770 flats	22,2 w/ 19,6 flats	.032	0,8	1810	1811	RDD 200-90	2509	DD 875-770
						.063	1,6					
SPT-3	18/2 18/3 16/2 16/3 14/2	.19 x .35 .19 x .39 .20 x .37 .20 x .43 .24 x .42	4,8 x 8,9 4,8 x 9,9 5,1 x 9,4 5,1 x 10,9 6,1 x 10,7			.099	2,5					
						.126	3,2					
						.157	4,0					

Standard color black. Consult Heyco for white and other colors.

- **Right Angle design eases the cable into the bend**, prevents kinking and assures longest cable and product life.
- Assembly friendly! Independent of insertion into the panel, RDD Lockit™ Strain Reliefs self-lock onto the cable. Preassemble RDD Lockits off line for final assembly at a later time or remote location, for lower installed cost!
- Install easily with fingertip pressure into a standard round or Double D hole. No tools required, even for hand assembly.
- Protect the lifeline of your electric/electronic products by absorbing the forces of push and pull that may be exerted on the flexible power cord. Double D design eliminates the possibility of part rotation under forces of twist.
- Multiple panel locking steps secure Lockit Strain Reliefs into a wide range of panel thicknesses for a **flush, finished fit**.
- Heyco’s automated Pre-Assembly Equipment speeds assembly of the RDD onto the cable and thus lowers costs while greatly reducing risk of carpal tunnel syndrome. See pages 4-15 & 4-16.
- Consult Heyco for other wire types and sizes.
- See page 4-38 for corresponding **Mounting Hole Plugs** which can be used to fill blank/unused Mounting Holes and thus allow for a single panel design for multiple applications.
- For Double D Mounting Hole Punches, see page 4-30.

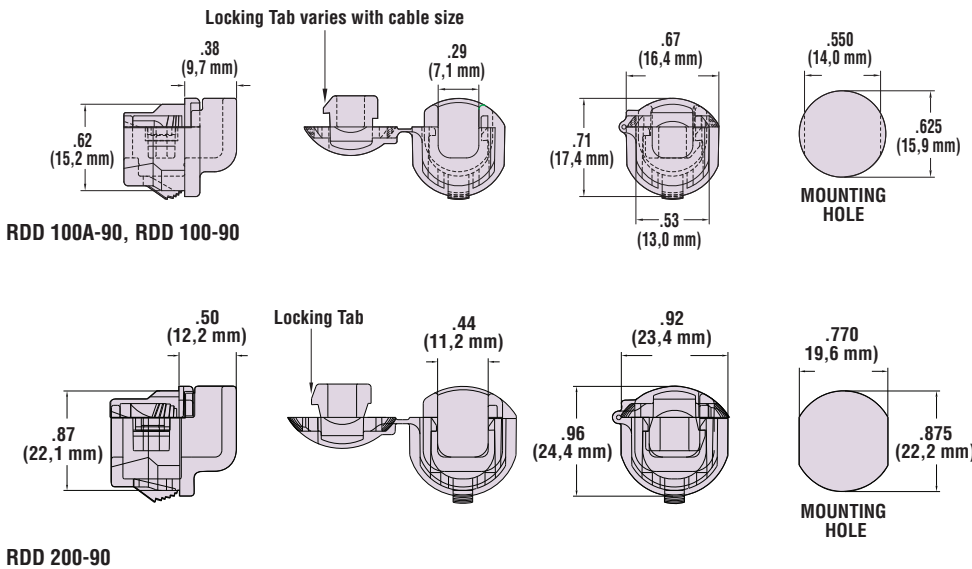

Material	Nylon 6/6
Certifications	Recognized under the Component Program of Underwriters' Laboratories File E15331 Certified by the Canadian Standards Association File 8919
Flammability Rating	94V-2
Temperature Range	-04°F (-18°C) to 221°F (105°C).

Quick Specs

Reduce risk of carpal tunnel syndrome!

Heyco® Lockit™ Strain Relief Pre-Assembly Equipment

Pre-Assembly Equipment for Heyco Assembly-Friendly Lockit Series Strain Reliefs:

RDD Lockits – for Double D and Round Mounting Holes.

ST Lockits – for Rectangular Mounting Holes.

Pre-Assemble Lockits onto cable for faster final assembly!

Watch this equipment in action at www.Heyco.com

Click on our Strain Relief Bushings Section and then the video Evolution of the Heyco Strain Relief Bushing in the upper left square.



A Headlock™ for RDD and ST Lockits

Assembly head for RDD and ST Lockit Strain Reliefs. Simply place a Lockit Strain Relief into the U opening of the assembly head. Then place the cable into the bushing body and close the head to secure the Lockit™ Strain Relief permanently onto the wire. This completed sub-assembly can then be installed with fingertip pressure into the application's mounting hole—at a later time, in a different place, for lower installed cost!

A



B FootLock™

Assembly machine for RDD and ST Lockit Strain Reliefs. This foot-pedal activated assembly machine is identical to Autolock™, except that the gravity fed track is loaded by hand instead of by a vibratory bowl.

B

C Autolock™ Semi-Automatic

Assembly machine for RDD and ST Lockit Strain Reliefs. Suitable for high volume production runs where batched sub-assemblies are desirable. Includes vibratory feeder bowl, track and head. The operator simply inserts the cable into the assembly head slot, then presses the foot pedal to secure the Strain Relief permanently onto the wire. This completed sub-assembly can be installed with fingertip pressure into the application's mounting hole—at a later time, in a different place, for lower installed cost!

Equipment for European requirements (motor power ratings and shielding) available, consult Heyco.

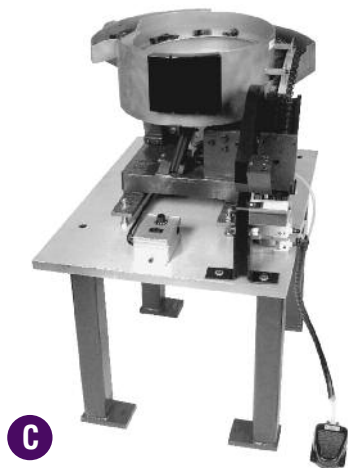

C

D RDD Lockit™ Guillotine - for fastest final assembly!

Optional guillotine type cutting attachment (not pictured) for the RDD Footlock™ and Autolock™ application equipment. The Lockit™ Guillotine removes the RDD hinge after attachment to the cable, thus reducing the clearance required for easy installation of the RDD/cable assembly, into the panel.

For Part No. and ordering, please consult Heyco.

For Lockit Strain Relief Hand Pliers see page 4-16.

Heyco® Lockit™ Strain Relief Pre-Assembly Equipment Directory

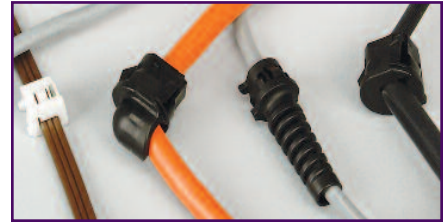

TO ASSEMBLE Lockit™ Strain Relief Series	Catalog Page Ref.	Hand Pliers	USE THE FOLLOWING PART NOS.				C† Eurolock
			A Headlock	B Footlock	C Autolock		

RDD Lockits

RDD 100, RDD 100A RDD 101, RDD 101A	4-11 4-7	0026	ST16	ST14, ST14E†	ST13	ST13E
RDD 100-90, RDD 100A-90 RDD 101-90, RDD 101A-90 RDD 100-7, RDD 100A-7 RDD 101-7	4-14 4-13 4-12 4-12	0026	*	*	*	*
RDD 200, RDD 200-2 RDD 201, RDD 201-2 RDD 301, RDD 301-2 RDD 401, RDD 401-2	4-11 4-8 4-8 4-8	0027	ST17	ST19	ST18	*
RDD 200-90 RDD 201-90 RDD 301-90	4-14 4-13 4-13	0027	ST17-90	ST19-90	*	*
RDD 501 RDD 510	4-9 4-11	**	ST20	ST27	ST26	*
RDD 601	4-9	**	ST31	ST34	*	*
RDD 6N-2	4-7	**	ST32	ST33	*	*
RDD 701	4-9	**	ST35	*	*	*

ST Lockits

ST 100L	4-6	0023	ST12	ST11	ST10	*
ST 100N ST 101N	4-6 4-5	0020	OST1	OST4	OST3	OST3E
ST 101A	4-31	0025	ST15	OST0	OST6	*
ST 200N ST 201N, ST 301N	4-6 4-5	0073	OST7	OST9	OST8	*

† ST14E guarding meets European standards.
Eurolock **ST13E** and **OST3E** have a 230V 50/60 Hz rated motor.
* Consult Heyco for availability.
** Headlock, Footlock or Autolock required due to cable thickness.

To use Hand Pliers with Lockit™ Strain Reliefs:

Position on Wire

Squeeze Pliers

Push into Double D (RDD) or Rectangular (ST) Mounting Hole

or Set Aside for Future Final Assembly



“Stay Connected” with



Strain Relief Bushings

a PennEngineering® Company



Heyco® Original Strain Relief Bushings

Straight-Thru for Flat Cables

.375" (9,5 mm) to .500" (12,7 mm) Mounting Holes

- **Protects the lifeline of your electric/ electronic products** by absorbing the forces of pull, push, and twist that may be exerted on the flexible power cord.
- Securely anchors, insulates, and protects cable at panel entry points.
- Sizes for thin .040" (1,0 mm) panel available: SR 4A-6 & SR 3A-4. See charts for details.
- See page 4-38 for corresponding **Mounting Hole Plugs** which can be used to fill blank/unused Mounting Holes and thus allow for a single panel design for multiple applications.
- Consult Heyco for other wire types and sizes.
- See pages 4-27 & 4-28 for SR assembly tools.
- For Double D Mounting Hole Punches, see page 4-30.

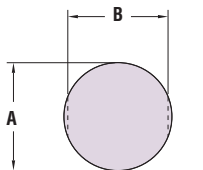

MOUNTING HOLE

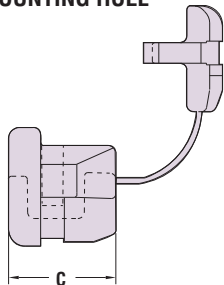

*To install strain reliefs for .040" (1,0 mm) maximum panel thickness, use **Part #0021** (No. R 291) Hand Pliers.

UL Type	WILL FIT THESE CABLES			PANEL DIMENSIONS						PART NO.	DESCRIPTION	PART DIM.		Mounting Hole Plug PART NO.	
	AWG/ Conductors	Approximate Size		A Mounting Hole Dia.		B To Prevent Rotation		Finished Fit Panel Thickness*				Black	C BODY LENGTH		
		in.	mm.	in.	mm.	in.	mm.	in.	mm.				in.		mm.
300 OHM†	20/2 22/2	.06 x .40	1,5 x 10,2	.375	9,5										
SPT-1	18/2 18/3	.12 x .30	3,0 x 7,6	.375 .390	9,5 9,9	.625-	15,9-								
SPT-2	18/2 18/3	.15 x .40	3,8 x 10,2	.415 .422	10,5 10,7	.640	16,3	.100	2,5	1814	SR 302-1**	.469	11,9	consult Heyco	
	16/2 16/3	.16 x .41	4,1 x 10,4	.422 .437	10,7 11,1										
Same as SR 302-1 above except									.156	4,0	1804	SR 300-1	.469	11,9	consult Heyco
CLOCK, X & XT	20/2	.09 x .18	2,3 x 4,6	.375	9,5	.345	8,8	.062	1,6	1017	SR 2P-4	.406	10,3	2617	
SPT-1	18/2	.11 x .21	2,8 x 5,3												
Same as SR 2P-4 above except									.125	3,2	1034	SR 2L-1	.406	10,3	2617
SPT-1	18/2	.12 x .22	3,0 x 5,6	.437	11,1	.390	9,9	.040 ***	1,0	1074	SR 3A-4	.406	10,3	2488	
Same as SR 3A-4 above except									.062	1,6	1077	SR 3P-4	.406	10,3	2488
									.100	2,5	1104	SR 3W-1	.406	10,3	
									.156	4,0	1094	SR 3L-1	.406	10,3	consult Heyco
SPT-1, SPT-2 & HPN	18/2	.12 x .22	3,0 x 5,6	.500	12,7	.445	11,3	.100	2,5	1130	SR 4P-4	.440	11,2	2491	
SPT-1	18/3	.12 x .30	3,0 x 7,6												
SPT-2 & HPN	18/2	.15 x .28	3,8 x 7,1	.500	12,7	.445	11,3	.062	1,6	1120	SR 4N-4	.406	10,3	2491	
Same as SR 4N-4 above except									.100	2,5	1117	SR 4K-4	.406	10,3	2491
									.156	4,0	1127	SR 4L-4	.406	10,3	consult Heyco
SPT-1	18/3	.12 x .30	3,0 x 7,6												
SPT-2 & HPN	18/2	.15 x .28	3,8 x 7,1	.500	12,7										
HPN	18/3	.15 x .34	3,8 x 8,6			.460	11,7	.095	2,4	1114	SR 4K-1	.500	12,7	2491	
SPT-2 HPN	16/2	.16 x .30	4,1 x 7,6	.500- .515	12,7- 13,1										
Same as SR 4K-1 above except									.187	4,7	1124	SR 4L-1	.500	12,7	consult Heyco

Standard color black. Consult Heyco for white and other colors.

†Wire is not UL/CSA approved.

* Maximum Panel Thickness. Part has additional clearance. Consult Heyco for your Custom Finished Fit Panel Thickness.

**Use Elongated Mounting Hole.

***To install Strain Reliefs for .040" (1,0 mm) Maximum Panel Thickness use Part No. **0021** (No. R 291) Hand Pliers.

Material
Certifications

Nylon 6/6
Recognized under the Component Program of Underwriters' Laboratories
File E15331

Flammability Rating
Temperature Range

94V-2
-04°F (-18°C) to 221°F (105°C)

“Stay Connected” with



Strain Relief Bushings

a PennEngineering® Company

Heyco® Original Strain Relief Bushings

Straight-Thru for Flat Cables

.560" (14,2 mm) to .875" (22,2 mm) Mounting Holes



UL Type	WILL FIT THESE CABLES				PANEL DIMENSIONS						PART NO.	DESCRIPTION	PART DIM.		Mounting Hole Plug PART NO.
	AWG/ Conductors	Approximate Size		A Mounting Hole Dia.		B To Prevent Rotation		Finished Fit Panel Thickness*		C BODY LENGTH					
		in.	mm.	in.	mm.	in.	mm.	in.	mm.	in.			mm.		
SPT-2	18/3	.15 x .40	3,8 x 10,2	.562	14,3	.530	13,5	.125	3,2	1174	SR 5W-1	.609	15,5	2494	
	16/3	.16 x .41	4,1 x 10,4												
HPN	16/2	.16 x .37	4,1 x 9,4	.562	14,3	.530	13,5	.125	3,2	1174	SR 5W-1	.609	15,5	2494	
	16/3	.16 x .42	4,1 x 10,5												
SPT-3	18/2	.19 x .35	4,8 x 8,9	.562	14,3	.530	13,5	.062	1,6	1170	SR 5KN-4	.609	15,5	2494	
	16/2	.20 x .37	5,1 x 9,4												
SPT-2 & HPN	16/3	.16 x .41	4,1 x 10,4												
Same as SR 5KN-4 above except										1167	SR 5K-4	.609	15,5	2494	
SPT-2	18/3	.15 x .40	3,8 x 10,2	.560	14,2	.730	18,5	.125	3,2	1484	SR 30-1**	.672	17,1	consult Heyco	
	16/3	.16 x .41	4,1 x 10,4												
SPT-3	18/2	.19 x .35	4,8 x 8,9	.750	19,0	.875	22,2	.125	3,2	1504	SR 33-1**	.781	19,8	consult Heyco	
	18/3	.19 x .39	4,8 x 9,9												
	16/2	.20 x .37	5,1 x 9,4												
	16/3	.20 x .43	5,1 x 10,9												
SPT-2	18/3	.15 x .40	3,0 x 7,6	.625	15,9	.550	14,0	.062	1,6	1160	SR 6N4-4	.578	14,7	2497	
	16/3	.16 x .41	4,1 x 10,4												
Same as SR 6N4-4 above except										1163	SR 6P4-4	.578	14,7	2497	
SPT-3	16/2	.20 x .37	5,1 x 9,4	.750	19,0	.875	22,2	.125	3,2	1504	SR 33-1**	.781	19,8	consult Heyco	
	16/3	.20 x .43	5,1 x 10,9												
	14/2	.24 x .42	6,1 x 10,7												
	14/3	.24 x .51	6,1 x 12,9												

Fit 1/2" Electrical Knock-out Hole

SPT-3	14/2	.24 x .42	6,1 x 10,7	.875	22,2	.840	21,3	.125	3,2	1517	SR 34-2	.813	20,7	2509
	14/3	.24 x .51	6,1 x 12,9											
	12/2	.29 x .51	7,4 x 12,9											
	12/3	.29 x .65	7,4 x 16,5											
SPT-3	12/3	.32 x .65	8,1 x 16,5	.875	22,2	.835	21,2	.125	3,2	1497	SR 31-2	.812	20,6	2509
	10/3													

Standard color black. Consult Heyco for white and other colors.

* Maximum Panel Thickness. Part has additional clearance. Consult Heyco for your Custom Finished Fit Panel Thickness.

**Use Elongated Mounting Hole.

- Protects the lifeline of your electric/electronic products by absorbing the forces of pull, push, and twist that may be exerted on the flexible power cord.
- Securely anchors, insulates, and protects cables at panel entry points.
- Consult Heyco for other wire types and sizes.
- See page 4-38 for corresponding **Mounting Hole Plugs** which can be used to fill blank/unused Mounting Holes and thus allow for a single panel design for multiple applications.
- See pages 4-27 & 4-28 for SR assembly tools.
- For Double D Mounting Hole Punches, see page 4-30.

DOUBLE D MOUNTING HOLE

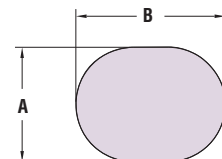
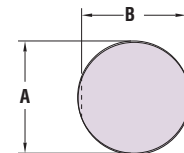

ELONGATED MOUNTING HOLE

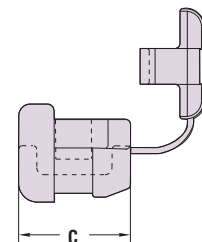

Material
Certifications

Nylon 6/6
 Recognized under the Component Program of Underwriters' Laboratories File E15331

Certified by the Canadian Standards Association File 8919

Flammability Rating
Temperature Range

94V-2
-04°F (-18°C) to 221°F (105°C)

Quick
Specs

"Stay Connected" with



Strain Relief Bushings

a PennEngineering® Company



Heyco® Original Strain Relief Bushings

Straight-Thru for Round Cables

.375" (9,5 mm) to .500" (12,7 mm) Mounting Holes

- Protects the lifeline of your electric/electronic products by absorbing the forces of pull, push, and twist that maybe exerted on the flexible power cord.
- Securely anchors, insulates, and protects cables at panel entry points.
- Sizes SR 2-Series to SR 6-Series for mounting hole diameters from .375" (9,5 mm) to .500" (12,7 mm).
- See page 4-38 for corresponding **Mounting Hole Plugs** which can be used to fill blank/unused Mounting Holes and thus allow for a single panel design for multiple applications.
- See pages 4-27 & 4-28 for SR assembly tools.
- See schematic on page 4-20.
- For Double D Mounting Hole Punches, see page 4-30.

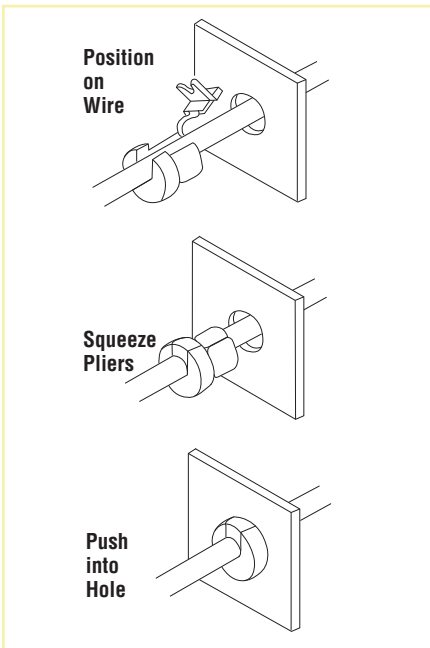

WILL FIT THESE CABLES				PANEL DIMENSIONS						PART NO.	DESCRIPTION	PART DIM.		Mounting Hole Plug	
UL Type	AWG/ Conductors	Approximate Size		A Mounting Hole Dia.		B To Prevent Rotation		Finished Fit Panel Thickness*				Black	C BODY LENGTH		PART NO.
		in.	mm.	in.	mm.	in.	mm.	in.	mm.	in.	mm.				
AWM	12/1	.125-.187	3,2-4,8	.375	9,5	.330	8,4	.062	1,6	1060	SR 2M-1	.406	10,3	2617	
SV & SVT	18/2	.220-.245	5,6-6,2	.500	12,7	.450	11,4	.062	1,6	1157	SR 5MN-3	.438	11,1	2491	
Same as SR 5MN-3 above except									.100	2,5	1140	SR 5M-3	.438	11,1	2491
For custom interlock cable, not UR		.250	6,4	.560	14,2	.730	18,5	.125	3,2	1487	SR 30-1A**	.672	17,1	consult Heyco	
		.265	6,7	.560	14,2	.730	18,5	.125	3,2	1490	SR 30-1B**				
SV & SVT	18/2	.250	6,4	.500	12,7	.450	11,4	.062	1,6	1150	SR 5N-4	.438	11,1	2491	
	18/3	.255	6,5	.500-.515	12,7-13,1										
HPD	18/2	.270	6,9	.500	12,7	.450	11,4	.062	1,6	1150	SR 5N-4	.438	11,1	2491	
	16/2	.290	7,4	.500-.515	12,7-13,1										
SJT	18/2	.300	7,6	.531	13,5	.450	11,4	.062	1,6	1150	SR 5N-4	.438	11,1	2491	
Same as SR 5N-4 above except															.100
									.156	4,0	1154	SR 5L-1	.438	11,1	consult Heyco
SV & SVT	18/2	.255	6,5	.500	12,7	.450	11,4	.100	2,5	1137	SR 5P3-4	.438	11,1	2491	
	18/3	.270	6,9												
HPD	18/2	.290	7,4	.500	12,7	.465	11,8	.090	2,3	1184	SR 6W-1	.438	11,1	2491	
SJ, SJT & SJO	18/2	.300	7,6												
SPT-3	16/2														

Standard color black. Consult Heyco for white and other colors.

*Maximum Panel Thickness. Part has additional clearance. Consult Heyco for your Custom Finished Fit Panel Thickness.

**Use Elongated Mounting Hole.

Quick Specs

Material
Certifications

Nylon 6/6



Recognized under the Component Program of Underwriters' Laboratories File E15331



Certified by the Canadian Standards Association File 8919

Flammability Rating
Temperature Range

94V-2

-.04°F (-18°C) to 221°F (105°C)

“Stay Connected” with



Strain Relief Bushings

a PennEngineering® Company

Heyco® Original Strain Relief Bushings

Straight-Thru for Round Cables
.625" (15,9 mm) to .750" (19,0 mm) Mounting Holes



WILL FIT THESE CABLES				PANEL DIMENSIONS						PART NO.	DESCRIPTION	PART DIM.		Mounting Hole Plug PART NO.	
UL Type	AWG/ Conductors	Approximate Size		A Mounting Hole Dia.		B To Prevent Rotation		Finished Fit Panel Thickness*				C BODY LENGTH			
		in.	mm.	in.	mm.	in.	mm.	in.	mm.	in.	mm.	in.	mm.		
SJ, SJT & SJO	18/2	.300	7,6	.625	15,9	.550	14,0	.062	1,6	1217	SR 6N-4	.578	14,7	2497	
Same as SR 6N-4 above except									.125	3,2	1210	SR 6P-4	.578		14,7
SJT	18/3	.300-.330	7,6-8,4	.625	15,9	.550	14,0	.062	1,6	1197	SR 6N2-4	.578	14,7		
SJ, SJT & SJO	16/2	.325	8,3	.625	15,9	.550	14,0	.062	1,6	1200	SR 6N3-4	.578	14,7		
	18/3	.330	8,4												
	14/2	.350	8,9												
	16/3	.355	9,0												
18/4	.360	9,1													
Same as SR 6N3-4 above except									.125	3,2	1207	SR 6P3-4	.578		14,7
S & ST	18/2	.380	9,7	.625	15,9	.550	14,0	.062	1,6	1202	SR 6N5-4	.578	14,7		
	16/2	.405	10,3												
Same as SR 6N5-4 above except									.125	3,2	1204	SR 6P5-4	.578	14,7	
SJ, SJT & SJO	18/2	.300	7,6	.625	15,9	.550	14,0	.156	4,0	1214	SR 6L-1	.678	17,2	consult Heyco	
	16/2	.325	8,3	.656	16,7										
	18/3	.330	8,4	.656	16,7										
HPD	16/3	.355	9,0	.687	17,4										
SJT	18/4	.360	9,1	.750	19,0	.660	16,8	.062	1,6	1244	SR 7N-2	.750	19,1	2503	
	14/3	.370	9,4												
S & ST	18/2	.390	9,9	.750-	19,0-	.660	16,8	.062	1,6	1244	SR 7N-2	.750	19,1		
	18/3	.405	10,3												.781
	16/2	.405	10,3												
16/3	.430	10,9													
Same as SR 7N-2 above except									.125	3,2	1237	SR 7P-2	.750	19,1	

Standard color black. Consult Heyco for white and other colors.

*Maximum Panel Thickness. Part has additional clearance. Consult Heyco for your Custom Finished Fit Panel Thickness.

- Protects the lifeline of your electric/electronic products by absorbing the forces of pull, push, and twist that may be exerted on the flexible power cord.
- Securely anchors, insulates, and protects cables at panel entry points.
- Sizes SR 6-Series to SR 7-Series for mounting hole diameters from .625" (15,9 mm) to .781" (19,8 mm).
- Sizes for thin .062" (1,6 mm) panel available: SR 7N-2 See chart for details.
- See page 4-38 for corresponding Mounting Hole Plugs which can be used to fill blank/unused Mounting Holes and thus allow for a single panel design for multiple applications.
- Consult Heyco for other wire types and sizes.
- See pages 4-27 & 4-28 for SR assembly tools.
- See page 4-19 for Quick Specs.
- For Double D Mounting Hole Punches, see page 4-30.

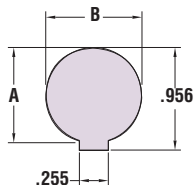

FOR SR-7KR-2 ONLY

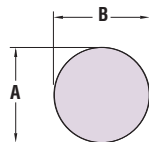

STANDARD MOUNTING HOLES

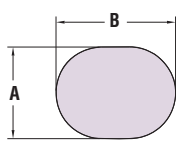

ELONGATED MOUNTING HOLE

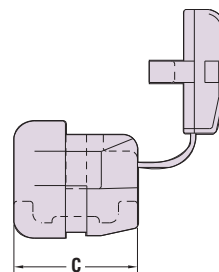



Heyco® Original Strain Relief Bushings

Straight-Thru for Round Cables

.875" (22,2 mm) to 1.187" (30,1 mm) Mounting Holes

Fit 1/2" or 3/4" Electrical Knock-out Hole Sizes

- **Protects the lifeline of your electric/ electronic products** by absorbing the forces of pull, push, and twist that may be exerted on the flexible power cord.
- Securely anchors, insulates, and protects cables at panel entry points.
- Sizes SR 7-Series to SR 9-Series for mounting hole diameters from .875" (22,2 mm) to 1.187" (28,6 mm).
- Sizes for thin .062" (1,6 mm) panel available:
SR 8N-2
See chart for details.
- See page 4-38 for corresponding **Mounting Hole Plugs** which can be used to fill blank/unused Mounting Holes and thus allow for a single panel design for multiple applications.
- Consult Heyco for other wire types and sizes.
- See pages 4-27 & 4-28 for SR assembly tools.
- For Double D Mounting Hole Punches, see page 4-30.

WILL FIT THESE CABLES				PANEL DIMENSIONS						PART NO.	DESCRIPTION	PART DIM.		Mounting Hole Plug PART NO.											
UL Type	AWG/ Conductors	Approximate Size		A Mounting Hole Dia.		B To Prevent Rotation		Finished Fit Panel Thickness*				Black	C BODY LENGTH												
		in.	mm.	in.	mm.	in.	mm.	in.	mm.		in.		mm.												
SJ, SJT & SJO	16/2	.325	8,3	.875	22,2	.770	19,6	.125	3,2	1240	SR 7K-2	.750	19,1	2509											
	18/3	.330	8,4																						
	14/2	.350	8,9																						
	16/3	.355	9,0																						
	18/4	.360	9,1																						
Same as SR 7K-2 above except				▶ See Schematic				.125	3,2	1271	SR 7KR-2	.750	19,1	2509											
SJT	14/3	.370	9,4	.875	22,2	.770	19,6	.125	3,2	1247	SR 7W-2	.750	19,1	2509											
	12/3	.425	10,8																						
S, SO, & ST	18/2	.390	9,9																						
	18/3	.405	10,3																						
	16/2	.405	10,3																						
16/3	.430	10,9																							
Same as SR 7W-2 above except				▶				.200	5,1	1250	SR 7L-2	.750	19,1	consult Heyco											
SJT	12/3	.425-.475	10,8-12,1	.875	22,2	.840	21,3	.125	3,2	1497	SR 31-2	.812	20,6	2509											
S & ST	14/2	.530	13,5	.875	22,2	.840	21,3	.062	1,6	1254	SR 8N-2	.828	21,0	2509											
	14/3	.560	14,2																						
	12/2	.600	15,3																						
Same as SR 8N-2 above except															▶				.125	3,2	1260	SR 8P-2	.812	20,6	2509
																			.187	4,8	1274	SR 8L-1	.812	20,6	consult Heyco
S	12/2	.600	15,2	1.093	27,7	1.000	25,4	.281	7,1	1287	SR 9P-2	1.000	25,4	2717											
	12/3	.635	16,1	1.125	28,6																				
	10/2	.640	16,3	1.093	27,7																				
S, SO & ST	10/3	.690	17,5	1.187	30,2																				
	SRDT														12/4										

Standard color black. Consult Heyco for white and other colors.

*Maximum Panel Thickness. Part has additional clearance. Consult Heyco for your Custom Finished Fit Panel Thickness.

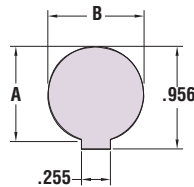

FOR SR-7KR-2 ONLY

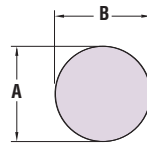

STANDARD MOUNTING HOLES

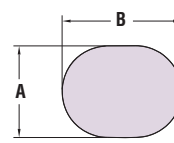

ELONGATED MOUNTING HOLE

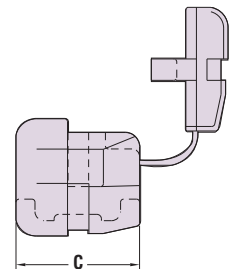

Quick Specs

Material	Nylon 6/6
Certifications	Recognized under the Component Program of Underwriters' Laboratories File E15331 Certified by the Canadian Standards Association File 8919
Flammability Rating	94V-2
Temperature Range	-.04°F (-18°C) to 221°F (105°C)



Heyco® Original Strain Relief Bushings

Internal Radii for Flat Cables
.500" (12,7 mm) Mounting Holes

WILL FIT THESE CABLES				PANEL DIMENSIONS						PART NO.	DESC.	PART DIMENSIONS				Mounting Hole Plug
UL Type	AWG/ Conds.	Approximate Size		A Mounting Hole Dia.		B To Prevent Rotation		Finished Fit Panel Thickness*				Black	C Head Length		D Body Length	
		in.	mm.	in.	mm.	in.	mm.	in.	mm.	in.	mm.		in.	mm.	in.	mm.
SPT-1	18/3	.12 x .30	3,0 x 7,6	.500	12,7	.465	11,8	.040	1,0	1181	SR 4A-6	.270	6,9	.546	13,9	2491
SPT-2 & HPN	18/2	.15 x .28	3,8 x 7,1													
SPT-1	18/3	.12 x .30	3,0 x 7,6	.500	12,7	.465	11,8	.062	1,6	1187	SR 4N-6	.270	6,9	.546	13,9	2491
SPT-2 & HPN	18/2	.15 x .28	3,8 x 7,1													
	16/2	.16 x .30	4,1 x 7,6	.515	13,1					1190	SR 4K-6	.270	6,9	.546	13,9	2491
Same as SR 4N-6 above except								.100	2,5	1190	SR 4K-6	.270	6,9	.546	13,9	2491

Standard color black. Consult Heyco for white and other colors.

* Maximum Panel Thickness. Part has additional clearance. Consult Heyco for your Custom Finished Fit Panel Thickness.

- Extra body length with **flex-protecting** internal radii.
- Wider approved wire range than typical 4-series Strain Reliefs; SR 4A-6 features a 1,0 mm locking slot for Thin Panels.
- Absorb forces of pull, push, and twist, to protect the electrical lifeline of your application.
- For maximum flex protection, see Bell-Mouth and Pigtail Strain Reliefs on pages 4-23 and 4-24.
- Securely anchors, insulates and protects cables at panel entry points.
- To assemble SR 4A-6 use **Part No. 0021 R 291 Pliers**, designed for .040" (1,0 mm) panel thickness, or semi-automated equipment.
- To assemble SR 4N-6 and SR 4K-6, use **Part No. 0022 R 29 Pliers**, or semi-automated equipment. See pages 4-27 thru 4-29 for details.
- Use Mounting Holes Plug **Part No. 2491** to standardize panel design where the Strain Relief is not required.
- For Double D Mounting Hole Punches, see page 4-30.

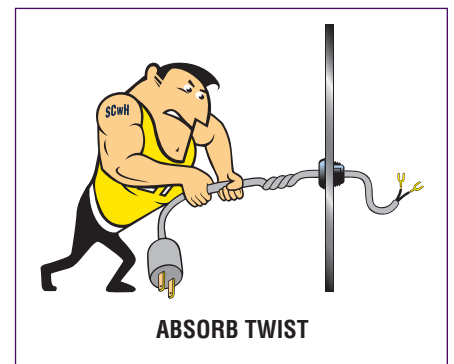
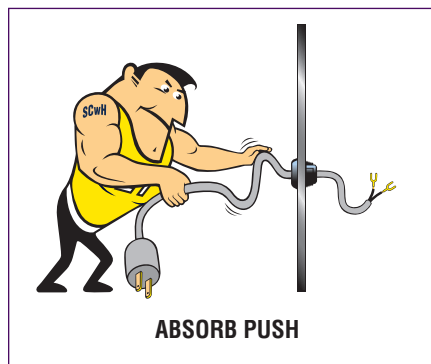
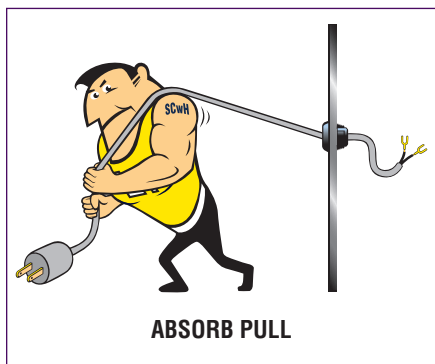
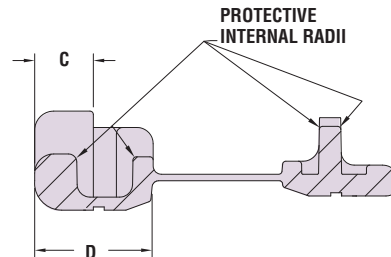
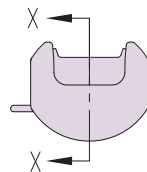
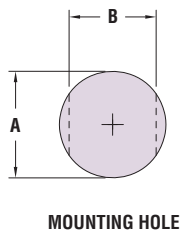

Material
Certifications

Nylon 6/6

Recognized under the Component Program of Underwriters' Laboratories File E15331

Certified by the Canadian Standards Association File 8919

Flammability Rating
Temperature Range

94V-2

-.04°F (-18°C) to 221°F (105°C)

Quick
Specs

“Stay Connected” with



Strain Relief Bushings

a PennEngineering® Company



Heyco® Original Strain Relief Bushings

Bell-Mouth for Flat and Round Cables

- Flared trumpet exit eases the cable into a lazy bend, prevents sharp bending, and assures longer cable and product life.
- Protects the lifeline of your electric/electronic products by absorbing the forces of pull, push, twist, and flex.
- Securely anchors, insulates, and protects cable at panel entry points.
- See page 4-38 for corresponding **Mounting Hole Plugs** which can be used to fill blank/unused Mounting Holes and thus allow for a single panel design for multiple applications.
- Consult Heyco for other wire types and sizes.
- See pages 4-27 & 4-28 for SR assembly tools.
- For Double D Mounting Hole Punches, see page 4-30.



UL Type	WILL FIT THESE CABLES		PANEL DIMENSIONS						PART NO. Black	DESC	PART DIMENSIONS				Mounting Hole Plug
	AWG/Conductors	Approximate Size	A Mounting Hole Dia.		B To Prevent Rotation		Finished Fit Panel Thickness*				C HEAD LENGTH		D BODY LENGTH		
		in. mm.	in.	mm.	in.	mm.	in.	mm.	in.	mm.	in.	mm.	in.	mm.	

For Flat Cables

CLOCK, X & XT	20/2	.09x.18	2,3x4,6								1020	SR 2P-5	.375	9,5	.625	15,9	consult Heyco
SPT-2	18/2	.11x.21	2,8x5,3	.375	9,5	.330	8,4	.062	1,6								
SPT-1	18/2	.12x.22	3,0x5,6	.437	11,1	.390	9,9	.062	1,6	1080	SR 3P-5	.375	9,5	.625	15,9	2488	
SPT-1	18/3	.12x.30	3,0x7,6														
SPT-2 & HPN	18/2	.15x.28	3,8x7,1	.500	12,7	.465	11,8	.062	1,6	1108	SR 4N-5	.406	10,3	.703	17,9	2491	
	16/2	.16x.30	4,1x7,6	.500	12,7												
HPN	18/3	.15x.34	3,8x8,6	.625	15,9	.550	14,0	.125	3,2	1229	SR 6K-5	.421	10,7	.813	20,7	2497	
	16/2	.16x.37	4,1x9,4														
SPT-2	16/2	.16x.30	4,1x7,6														
	16/3	.16x.41	4,1x10,4														

For Round Cables

SV & SVT	18/2	.250	6,3	.500	12,7												
	18/3	.255	6,5	.500-.515	12,7-13,1												
HPD	18/2	.270	6,9	.500	12,7	.450	11,4	.062	1,6	1143	SR 5N-5	.406	10,3	.688	17,5	2491	
	16/2	.290	7,4	.500-.515	12,7-13,1												
SJ & SJT	18/2	.300	7,6	.531	13,5												
SJ, SJO & SJT	18/2	.300	7,6	.625	15,9	.550	14,0	.125	3,2	1226	SR 6P-5						
	16/2	.315	8,0	.625	15,9	.550	14,0	.125	3,2	1232	SR 6P2-5	.421	10,7	.813	20,7	2497	
	18/3	.320	8,1														
SJ	14/2	.320	8,1														
SJ, SJO & SJT	16/2	.325	8,2	.625	15,9	.550	14,0	.062	1,6	1223	SR 6N3-5	.421	10,7	.813	20,7	2497	
	18/3	.330	8,4														
	14/2	.350	8,9														
	16/3	.355	9,0														
	18/4	.360	9,1														
Same as SR 6N3-5 above except									.125	3,2	1220	SR 6P3-5	.421	10,7	.813	20,7	2497

Standard color black. Consult Heyco for white and other colors.

*Maximum Panel Thickness. Part has additional clearance. Consult Heyco for your Custom Finished Fit Panel Thickness.

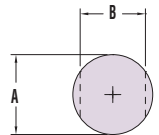

MOUNTING HOLE

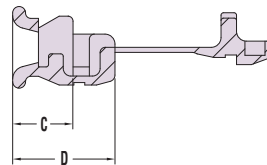
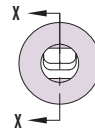

Quick Specs

Material
Certifications

Nylon 6/6

Recognized under the Component Program of Underwriters' Laboratories File E15331

Certified by the Canadian Standards Association File 8919

Flammability Rating
Temperature Range

94V-2

-.04°F (-18°C) to 221°F (105°C)

“Stay Connected” with



Strain Relief Bushings

a PennEngineering® Company



Heyco® Original Strain Relief Bushings

Pigtail with Integral Nylon Spring, for Flat and Round Cables

WILL FIT THESE CABLES				PANEL DIMENSIONS						PART NO. Black	DESC	PART DIMENSIONS				Mounting Hole Plug PART NO.
UL Type	AWG/ Conductors	Approximate Size		A Mounting Hole Dia.		B To Prevent Rotation		Finished Fit Panel Thickness*				C HEAD LENGTH		D BODY LENGTH		
		in.	mm.	in.	mm.	in.	mm.	in.	mm.	in.	mm.	in.	mm.			
For Flat Cables																
SPT-1	18/3	.12x.30	3.0x7.6													
SPT-2 & HPN	18/2	.15x.28	3.8x7.1	.500	12.7	.465	11.8	.062	1.6	1541	SR 4N-7	1.718	43.6	1.984 50.4 2491		
For Round Cables																
SV & SVT	18/2	.250	6.4	.500	12.7	.450	11.4	.062	1.6	1590	SR 5N-7	1.703	43.3	1.984 50.4 2491		
	18/3	.255	6.5	.500-.515	12.7-13.1											
HPD	18/2	.270	6.9	.500	12.7	.450	11.4	.062	1.6	1590	SR 5N-7	1.703	43.3	1.984 50.4 2491		
	16/2	.290	7.4	.500-.515	12.7-13.1											
Same as SR 5N-7 above except → .125 3.2 1593 SR 5P-7 1.703 43.3 1.984 50.4 2491																
SJ, SJO & SJT	18/2	.300	7.6	.625	15.9	.550	14.0	.062	1.6	1596	SR 6N-7	1.718	43.6	2.109 53.6 2497		
Same as SR 6N-7 above except → .125 3.2 1602 SR 6P-7 1.718 43.6 2.109 53.6 2497																
SJ, SJO & SJT	16/2	.315	8.0	.625	15.9	.550	14.0	.062	1.6	1599	SR 6N3-7	1.718	43.6	2.109 53.6 2497		
	18/3	.320	8.1													
	14/2	.350	8.9													
	16/3	.355	9.0													
	18/4	.360	9.1													
Same as SR 6N3-7 above except → .125 3.2 1605 SR 6P3-7 1.718 43.6 2.109 53.6 2497 1604 SR 6P3-7S**																
SJT	18/4	.360	9.1	.750	19.0	.660	16.8	.125	3.2	1611	SR 7P-7	2.156	54.9	2.598 66.0 2503		
SJT & SJTO	14/3	.370	9.4													
S & ST	18/2	.390	9.9	.750-.781	19.0-19.8	.660	16.8	.125	3.2	1611	SR 7P-7	2.156	54.9	2.598 66.0 2503		
	18/3	.405	10.3													
	16/2	.405	10.3													
	16/3	.430	10.9													

Standard color black. Consult Heyco for white and other colors.

*Maximum Panel Thickness. Part has additional clearance. Consult Heyco for your Custom Finished Fit Panel Thickness.

**For use in split housings only: Larger locking step on body and key, for additional pull out resistance.

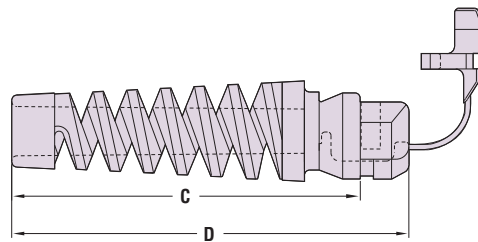
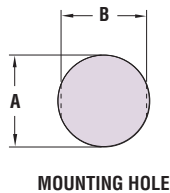

- **Integral nylon spring eases the cable into a lazy bend;** prevents sharp bending and assures longest cable and product life.
- Adds reliability, longevity, and safety. Will pass CSA's 50,000 cycle vacuum cleaner test (C22.2 No. 67).
- Protects the lifeline of your electric/electronic products by absorbing the forces of pull, push, twist, and flex.
- Securely anchors, insulates, and protects cables at panel entry points.
- Not recommended for applications where the power supply cord is subject to whipping or jump rope type motion.
- See page 4-38 for corresponding **Mounting Hole Plugs** which can be used to fill blank/unused Mounting Holes and thus allow for a single panel design for multiple applications.
- Consult Heyco for other wire types and sizes.
- See pages 4-27 & 4-28 for SR assembly tools.
- For Double D Mounting Hole Punches, see page 4-30.

Material

Nylon 6/6

Certifications



Recognized under the Component Program of Underwriters' Laboratories File E15331



Certified by the Canadian Standards Association File 8919

Flammability Rating

94V-2

Temperature Range

-.04°F (-18°C) to 221°F (105°C)

Quick Specs

“Stay Connected” with



Strain Relief Bushings

a PennEngineering® Company



Heyco® Original Strain Relief Bushings

Right Angle for Round Cables

- Provides the same protection for your power supply cable as the straight-thru type AND...
- **Exits the cable flush against the panel**, saving space and directing the cable parallel to the panel.
- Overcomes space limitations and acts as a back or bottom bumper.
- See page 4-38 for corresponding **Mounting Hole Plugs** which can be used to fill blank/unused Mounting Holes and thus allow for a single panel design for multiple applications.
- Consult Heyco for other wire types and sizes.
- See pages 4-27 & 4-28 for SR assembly tools.
- For Double D Mounting Hole Punches, see page 4-30.

UL Type	WILL FIT THESE CABLES			PANEL DIMENSIONS				PART NO. Black	DESC.	PART DIMENSIONS				Mounting Hole Plug PART NO.		
	AWG/ Conductors	Approximate Size		A Mounting Hole Dia.		B To Prevent Rotation				Finished Fit Panel Thickness*		C HEAD LENGTH			D BODY LENGTH	
		in.	mm.	in.	mm.	in.	mm.			in.	mm.	in.	mm.		in.	mm.
SV & SVT	18/2	.250	6,4	.500	12,7	.450	11,4	.100	2,5	1374	SR 15-1	.390	9,9	.687	17,5	2491
	18/3	.265	6,7	.500-.515	12,7-13,1											
HPD	18/2	.270	6,9	.500	12,7	.450	11,4	.100	2,5	1374	SR 15-1	.390	9,9	.687	17,5	2491
	16/2	.290	7,4	.500-.515	12,7-13,1											
SJ, SJO & SJT	18/2	.300	7,6	.625	15,9	.550	14,0	.125	3,2	1320	SR 10-2	.563	14,3	.968	24,6	2497
	16/2	.325	8,3													
	18/3	.330	8,4													
SJ	16/3	.330	8,4	.625	15,9	.550	14,0	.125	3,2	1327	SR 11-2	.563	14,3	.968	24,6	2497
SJ, SJO & SJT	16/2	.325	8,3													
	18/3	.330	8,4													
SJT	16/3	.335	9,0	.750	19,0	.660	16,8	.125	3,2	1397	SR 17-2	.640	16,3	1.093	27,7	2503
SJT & SJTO	14/3	.370	9,4													
SJ & ST	18/2	.390	9,9	.750	19,0	.660	16,8	.125	3,2	1397	SR 17-2	.640	16,3	1.093	27,7	2503
	18/3	.405	10,3													
	16/2	.405	10,3													
	16/3	.430	10,9													

Standard color black. Consult Heyco for white and other colors.

*Maximum Panel Thickness. Part has additional clearance. Consult Heyco for your Custom Finished Fit Panel Thickness.

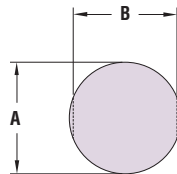

MOUNTING HOLES

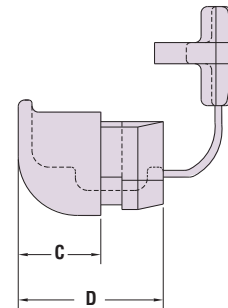

Quick Specs

Material	Nylon 6/6
Certifications	UL Recognized under the Component Program of Underwriters' Laboratories File E15331 CSA Certified by the Canadian Standards Association File 8919
Flammability Rating	94V-2
Temperature Range	-.04°F (-18°C) to 221°F (105°C)

“Stay Connected” with



Strain Relief Bushings

a PennEngineering® Company



Heyco® Original Strain Relief Bushings

Right Angle for Flat Cables

UL Type	WILL FIT THESE CABLES		PANEL DIMENSIONS								PART NO. Black	DESC	PART DIMENSIONS				Mounting Hole Plug PART NO.	
	AWG/ Conductors	Approximate Size		A Mounting Hole Dia.		B To Prevent Rotation		Finished Fit Panel Thickness*		C HEAD LENGTH			D BODY LENGTH					
		in.	mm.	in.	mm.	in.	mm.	in.	mm.				in.	mm.	in.	mm.		
SPT-1 SPT-1	18/2 18/3	.12x.22 .12x.30	3,0x5,6 3,0x7,6	.437	11,1	.390	9,9	.062	1,6	1354	SR 13-1	.234	5,9	.500	12,7	2488		
SPT-2 HPN	18/2 16/2	.15x.28 .16x.30	3,8x7,1 4,1x7,6	.500	12,7	.450	11,4	.040	1,0	1361	SR 14A-1	.390	9,9	.687	17,5	2491		
Same as SR 14A-1 above except										.100	2,5	1364	SR 14-1	.390	9,9	.687	17,5	2491
SPT-2 & HPN	18/3	.15x.40	3,8x10,2															
SPT-3 & HPN	18/2 16/2	.19x.35 .20x.37	4,8x8,9 5,1x9,4	.562	14,3	.525	13,3	.125	3,2	1384	SR 16-1	.500	12,7	.859	21,8	2494		
HPN	16/3	.16x.37	4,1x9,4															
SPT-2	18/3 16/3	.15x.40 .16x.41	3,8x10,2 4,1x10,4															
SPT-3	18/2	.19x.35	4,8x8,9	.560	14,2	.730	18,5	.080	2,0	1424	SR 20-1	.406	10,3	.812	20,6	consult Heyco		
	18/3	.19x.39	4,8x9,9	**	**	**	**				**							
	16/2	.20x.37	5,1x9,4															
	16/3	.20x.43	5,1x10,9															
Same as SR 20-1 above except										.125	3,2	1434	SR 20L-1	.406	10,3	.812	20,6	consult Heyco
SPT-3	16/2	.20x.37	5,1x9,4	.750	19,9	.875	22,2	.125	3,2	1454	SR 23-1	.484	12,3	.937	23,8	consult Heyco		
	16/3	.20x.43	5,1x10,9	**	**	**	**				**							
	14/2	.24x.42	6,1x10,7															
	14/3	.24x.51	6,1x13,0															

Fit 1/2" and 3/4" Electrical Knock-out Hole Sizes

SPT-3	14/2	.24x.42	6,1x10,7													
	14/3	.24x.51	6,1x13,0													
	12/3	.29x.51	7,4x13,0	.875	22,2	.840	21,3	.125	3,2	1464	SR 24-1	.500	12,7	.968	24,6	2509
	12/3	.29x.65	7,4x16,5													
SPT-3, SRD & SRDT	10/3	.32x.66	8,0x16,8	1.093	28,0	1.000	25,4	.125	3,2	1440	SR 21-2	.734	18,6	1.437	36,5	2717

Standard color black. Consult Heyco for white and other colors.

*Maximum Panel Thickness. Part has additional clearance. Consult Heyco for your Custom Finished Fit Panel Thickness.

**Use Elongated Mounting Hole.

- Provides the same protection for your power supply cable as the straight-thru type AND...
- **Exits the cable flush against the panel**, saving space and directing the cable parallel to the panel.
- Overcomes space limitations and acts as a back or bottom bumper.
- See page 4-38 for corresponding **Mounting Hole Plugs** which can be used to fill blank/unused Mounting Holes and thus allow for a single panel design for multiple applications.
- Consult Heyco for other wire types and sizes.
- See pages 4-27 & 4-28 for SR assembly tools.
- **See page 4-25 for Quick Specs.**
- For Double D Mounting Hole Punches, see page 4-30.

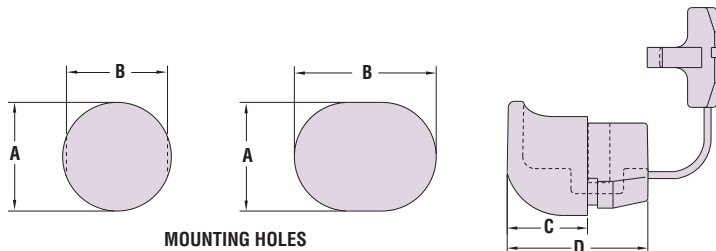

“Stay Connected” with



Strain Relief Bushings

a PennEngineering® Company



Heyco® Original Strain Relief Bushing Assembly Pliers Instructions and Spare Parts

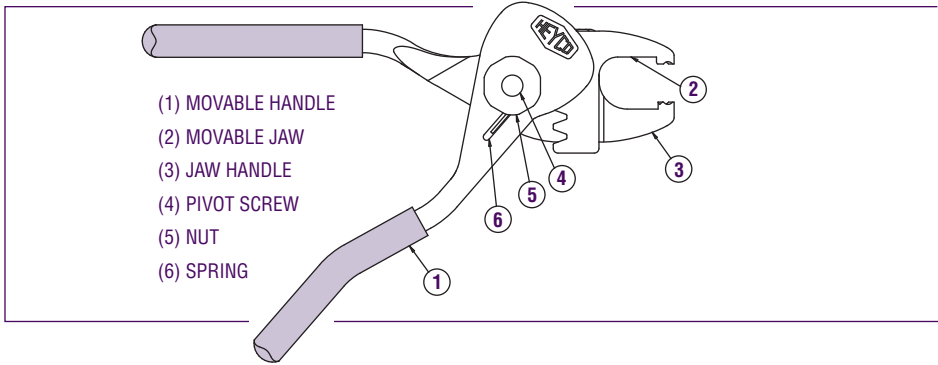

DESCRIPTION	SPARE PART NO.		Drawing Ref. No.
	for 0022 R 29 Plier	for 0030 R 30 Plier	
Grips	0037	0047	1
Pivot Screw	0036	0046	4
Nut	0032	0032	5
Spring	0031	0031	6

Part No. 0022

R 29 Pliers are shipped set for a 1/4" (6,4 mm) opening.

Part No. 0030

R 30 Pliers are shipped set for a 37/64" (14,7 mm) opening.

These Pliers will assemble the majority of our **Heyco Original Strain Relief Bushings** (see Directory, opposite). If adjustment is necessary, follow the instructions below:

- A. Remove Nut (5) and Spring (6).
- B. Close Pliers and lift off Movable Handle (1).
- C. Move Jaw (2) to desired opening (see Directory, opposite).
- D. Reassemble Handle (1) in **closed** position so that the gear teeth engage.
- E. Open Pliers and replace Spring (6) with short end in deepest recess, long end in Handle groove.
- F. Replace and secure Nut (5).

See opposite page for alternative jaw openings.

For Original Strain Relief Assembly **Air Tools**, see page 4-29.

Assembly Instructions:

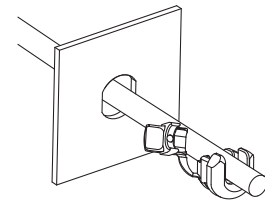

Position on Wire

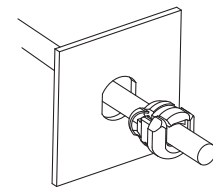

Squeeze Pliers

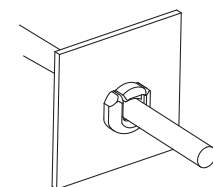

Push into Double D Mounting Hole

“Stay Connected” with



Strain Relief Bushings

a PennEngineering® Company

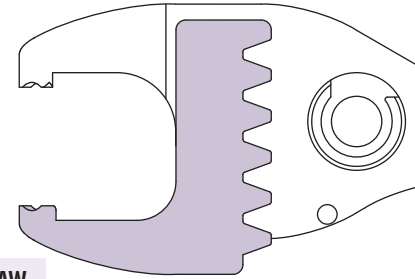

Heyco® Original Strain Relief Bushing Assembly Pliers Directory and Jaw Settings Guide

MOUNTING HOLE DIA.		Page No.	HEYCO ORIGINAL STRAIN RELIEFS		PLIER JAW OPENING	
in.	mm.		Strain Relief Description for Flat Cables	Page No.	Strain Relief Description for Round Cables	in.
Use PART NO. 0022 R 29 Plier						
.375	9,5	4-17 4-23	SR 302-1, SR 300-1, SR 2P-4, SR 2L-1 SR 2P-5	4-19	SR 2M-1	No Opening
.437	11,1	4-17 4-23 4-26	SR 3P-4, SR 3W-1, SR 3L-1 SR 3P-5 SR 13-1			11/32 8,7
.500	12,7	4-17 4-17 4-18 4-22 4-23 4-24 4-26	SR 4P-4, SR 4N-4, SR 4K-4, SR 4L-4 SR 4K-1, SR 4L-1 SR 5W-1, SR 5KN-4, SR 5K-4 SR 4N-6, SR 4K-6 SR 4N-5 SR 4N-7 SR 14-1	4-19 4-19 4-23 4-24 4-25	SR 5MN-3, SR 5M-3, SR 5N-4, SR 5P-4 SR 5L-1, SR 5P3-4, SR 6W-1 SR 5N-5 SR 5N-7, SR 5P-7 SR 15-1	11/32 8,7
.560	14,2	4-18 4-26	SR 30-1 SR 16-1, SR 20-1, SR 20L-1	4-19	SR 30-1A, SR 30-1B	11/32 8,7
.625	15,9	4-18 4-23	SR 6N4-4, SR 6P4-4 SR 6K-5	4-20 4-20 4-23 4-24 4-25 4-34	SR 6N-4, SR 6P-4, SR 6N2-4, SR 6N3-4 SR 6P3-4, SR 6L-1 SR 6P-5, SR 6P2-5, SR 6N3-5, SR 6P3-5 SR 6N-7, SR 6P-7, SR 6N3-7, SR 6P3-7, SR 6P3-7S SR 10N-2, SR 10-2, SR11-2, SR 11K-2 SR 6P10 CEE, SR 6P30 CEE	11/32 8,7
.750	19,1	4-18 4-24 4-26	SR 33-1 SR 7P-7 SR 23-1	4-20 4-25	SR 7P-2 SR 17-2	19/32 15,1
.875	22,2	4-18 4-26	SR 34-2, SR 31-2 SR 24-1	4-21 4-21	SR 7K-2, SR 7KR-2, SR 7W-2, SR 7L-2 SR 31-2, SR 8P-2, SR 8L-1	19/32 15,1
Use PART NO. 0021 R 291 Plier – for .040" (1,0 mm) panel thickness Strain Reliefs						
.437	11,1	4-17	SR 3A-4			11/32 8,7
.500	12,7	4-22 4-26	SR 4A-6 SR 14A-1			11/32 8,7
Use PART NO. 0030 R 30 Plier – more leverage for thicker cables						
.750	19,1	4-18 4-24 4-26	SR 33-1 SR 7P-7 SR 23-1	4-20 4-25	SR 7P-2 SR 17-2	37/64 14,7
.875	22,2	4-18 4-26	SR 34-2, SR 31-2 SR 24-1	4-21 4-21	SR 7K-2, SR 7KR-2, SR 7W-2, SR 7L-2 SR 31-2, SR 8P-2, SR 8L-1	37/64 14,7
1.093	27,8	4-26	SR 21-2	4-21 4-21	SR 9P-2, for 1-3/32" (27,8 mm) MH SR 9P-2, for 1-3/16" (30,2 mm) MH	27/32 21,4 1-7/64 28,2
Use PART NO. 0028 R 301 Plier – for SR 7N-2 and SR 8N-2 only						
.750	19,1			4-20	SR 7N-2	37/64 14,7
.875	22,2			4-21	SR 8N-2	

For Original Strain Relief Assembly **Air Tools**, see page 4-29.

“Stay Connected” with



Strain Relief Bushings

a PennEngineering® Company



Heyco® Original Strain Relief Bushing Air Tool, Air Tool Jaws & Replacement Parts

Air Tool and Air Tool Jaws Directory

Ordering Procedure for Air Tools:

- On the tabular chart, locate the panel mounting hole diameter and Original Strain Relief Bushing that you are using.
- The appropriate Air Tool is shown on the same line.
- Jaws may be purchased separately, see the two right most PART NO. columns.
- Bench Mount Kit **Part No. OT02** provides the necessary components to convert a hand Air Tool to a bench mounted unit. The bench Air Tool can be mounted in any convenient position on the assembly area work surface. The unit is foot activated, leaving the operator’s hands free. See below.
- For Original Strain Relief **Assembly Pliers**, see pages 4-27 & 4-28.
- For attaching Pliers for Metal Strain Reliefs, see page 4-30.

PANEL HOLE DIAMETER		FOR ORIGINAL STRAIN RELIEF BUSHINGS	AIR TOOL PART NO. inc. Jaws	JAW PART NO. *	
in.	mm.			Upper	Lower
.375	9,5	2L-1, 2M-1, 2P-4, 2P-5	0171	OT47	OT48
.437	11,1	3A-4	0173	OT49	OT50
		3L-1, 3P-4, 3P-5, 3W-1, 13-1	0175	OT51	OT52
.500	12,7	4A-6, 14A-1	0177	OT53	OT54
		4K-1, 4K-4, 4K-6, 4L-1, 4L-4, 4N-4, 4N-5, 4N-6, 4N-7, 4P-4, 5L-1, 5M-3, 5MN-3, 5N-4, 5N-5, 5N-7, 5P-4, 5P-7, 5P3-4, 6W-1, 14-1, 15-1	0179	OT55	OT56
.562	14,3	5K-4, 5KN-4, 5W-1, 16-1	0181	OT59	OT60
.625	15,9	6K-5, 6L-1, 6N-4, 6N-7, 6N2-4, 6N3-4, 6N3-5, 6N3-7, 6N4-4, 6P-4, 6P-5, 6P-7, 6P2-5, 6P3-4, 6P3-5, 6P3-7, 6P4-4, 6P10, 6P30, 10N-2, 10-2, 11-2, 11K-2	0183	OT61	OT62
		7N-2	0185	OT63 ¹	OT64 ²
.750	19,0	7P-2, 7P-7, 17-2	0187	OT65 ¹	OT66 ²
		7K-2, 7KR-2, 7L-2, 7W-2, 8L-1, 8P-2, 24-1, 31-2, 34-2	0189	OT67 ¹	OT68 ²
.875	22,2	8N-2	0193	OT71 ¹	OT72 ²
		300-1, 302-1	0191	OT69	OT70
.375x.625	9,5x15,9	20-1, 20L-1, 30-1, 30-1A, 30-1B	0195	OT73	OT74
.560 x .730	14,2 x 18,5	23-1, 33-1	0197	OT75	OT76 ²

¹ Secondary (upper) Jaw style. When ordering additional spacer may be required (P/N OT36[2]).

² Secondary (lower) Jaw style. When ordering additional spacer may be required (P/N OT77[1]).

* Jaw part number if purchased separately. See drawing below.

Air Tool Replacement Parts



Part No. OT02 Bench Mount Kit shown installed with Heyco Air Tool

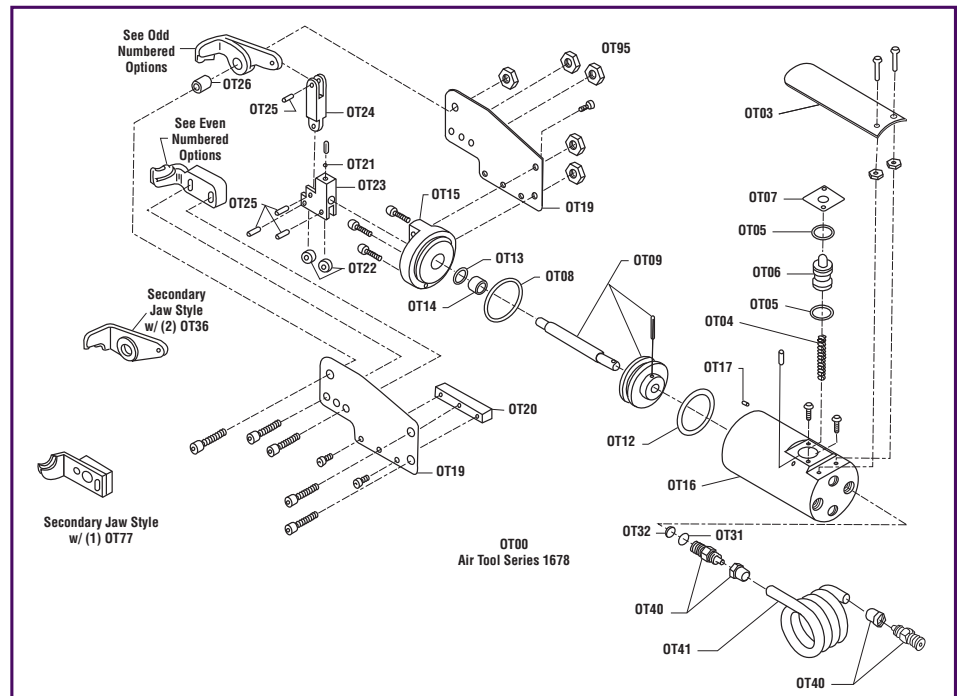

“Stay Connected” with



Strain Relief Bushings

a PennEngineering® Company



Heyco® Strain Relief Mounting Hole Punches

Maximum Gauge for Mild Steel	PANEL DIMENSIONS				PART NO.	DESCRIPTION	REQUIRED PULLER
	A Mounting Hole Dia.		B To Prevent Rotation				
	in.	mm.	in.	mm.			
16 ga.	.375	9,5	.330	8,4	1333	SRP 375-330	1350*
			.345	8,8	1334	SRP 375-345	
14 ga.	.437	11,1	.390	9,9	1335	SRP 437-390	1351*
			.450	11,4	1337	SRP 500-450	
			.460	11,7	1339	SRP 500-460	
	.500	12,7	.465	11,8	1340	SRP 500-465	1351*
			.530	13,5	1341	SRP 562-530	
	.625	15,9	.550	14,0	1342	SRP 625-550	1352**
			.660	16,8	1344	SRP 750-660	
	.750	19,1	.770	19,6	1345	SRP 875-770	1352**
			.840	21,3	1346	SRP 875-840	
	1.000	25,4	.875	22,2	1336	SRP 1000-875	1352**
			.970	24,6	1338	SRP 1093-970	
1.093	27,8	1.000	25,4	1347	SRP 1093-1000	1353**	
		1.109	28,2	1.000	25,5		1343
1.130	28,7	1.005	25,5	1348	SRP 1130-1005	1353**	

NEW!

NEW!

NEW!

*May be operated manually or used with a hydraulic puller.

**For use with CYL-201 and CYL-205A cylinders. May also be compatible with other industry standard pullers having a 3/4"-16 socket.

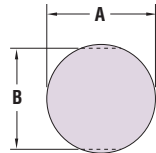

MOUNTING HOLE

- Double D configuration protects your strain relief and cable assembly from the forces of twist.
- Unique design prevents metal distortion during punching operation.
- Allows for the punching of mild steel, aluminum, fiberglass, and plastic.
- Available by special order only.

Operating Instructions for Heyco® Strain Relief Mounting Hole Punches

- Drill hole in panel one size larger than the stud of the punch.
- Disassemble punch and insert stud through hole.
- Install die and backing plate onto shaft then bearing and nut.
- Line up punch shaft to desired position and turn nut until punch goes through the metal.
- Disassemble nut bearing and backing plate and remove the slug from the die.
- Repeat process on next hole.
- ALWAYS REMOVE SLUG AFTER PUNCHING!



Heyco® Metal Strain Relief Bushings

For Round Cables

WILL FIT THESE CABLES Approximate Diameter				PART NO.	DESCRIPTION	PART DIMENSIONS						ATTACHING PLIERS PART NO.
Minimum		Maximum				O		W		L		
in.	mm.	in.	mm.			in.	mm.	in.	mm.	in.	mm.	
.250	6,4	.345	8,8	7412	MSR-1B	.29	7,4	.50	12,7	.17	4,3	0018
				7410	MSR-1	.29	7,4	.59	15,0	.17	4,3	
				7418	MSR-2S	.29	7,4	.78	19,8			
				7420	MSR-2	.29	7,4	.76	19,3			
.300	7,6	.345	8,8	7411	MSR-1A	.20	5,1	.53	13,5	.17	4,3	0018
				7419	MSR-2A	.20	5,1	.78	19,8			
.340	8,6	.390	9,9	7414	MSR-2W	.26	6,6	.78	19,8	.17	4,3	0018
.375	9,5	.420	10,7	7421	MSR-2WS	.28	7,1	.78	19,8	.17	4,3	0019
				7422	MSR-1C	.29	7,4	.59	15,0	.21	5,3	

- Designed to be attached to wire and cable inside of the panel.
- Easy assembly with recommended hand pliers.
- Permanent grip, nonslip design.
- Absorbs pull force only, to help meet UL and CSA requirements.
- Made of plated steel.
- DFARS Compliant

Heyco® Attaching Pliers for Metal Strain Reliefs



PN 0018 (1AB) & PN 0019 (R12)

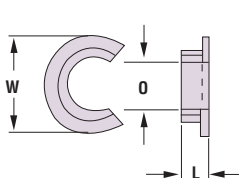

7410, 7411, 7412, 7422

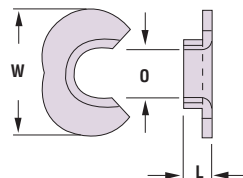

7414, 7418, 7419, 7421

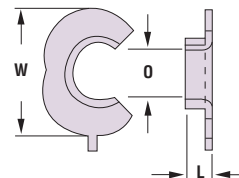

7420, 7430

“Stay Connected” with



Strain Relief Bushings

a PennEngineering® Company



Heyco® Multi-Lockit™ Strain Relief Bushing

For Round and Flat Cables

LSR 1939-300

- **Assembly friendly!** Independent of insertion into the panel, LSR 1939-300 **self-locks** onto the cable. Preassemble off line for final assembly at a later time or remote location, for lower installed cost!
- Large mounting hole design allows passage of plugs or bulky assemblies during installation.
- Passes UL pull-out test requirements with or without panel support.
- Protects the lifeline of your electric/electronic products by absorbing the forces of push and pull that may be exerted on the flexible power cord.
- Rectangular design eliminates the possibility of part rotation under forces of twist.

UL Type	WILL FIT THESE CABLES		PANEL DIMENSIONS				PART NO.	DESCRIPTION	
	AWG/Conductors	Approximate Size	Mounting Hole Size		Thickness				
		in.	mm.	in.	mm.	in.	mm.	Black	
Round Cable	18/3	.250	6,4	1.142 x 1.142	29,0 x 29,0	.032	0,8	1843	LSR 1939-300
Flat Cable SPT-3		.173 x .380	4,39 x 9,65						

Standard color black. Consult Heyco for white and other colors.

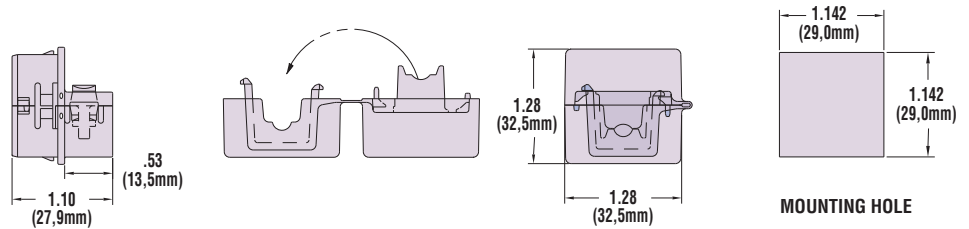

ST 101A

- Designed to be installed in a U shape panel slot (see schematic). Securely anchors, insulates, and protects cables at panel entry point. Slim head profile makes ST 101A design-specific.
- Heyco's automated Pre-Assembly Equipment speeds assembly of the Lockit onto the cable and thus lowers costs while greatly reducing risk of carpal tunnel syndrome. See pages 4-15 & 4-16.
- Consult Heyco for other wire types and sizes.

Heyco® ST Lockit™ Strain Relief Bushing for U-Shape Slot

For Round and Flat Cables

UL Type	WILL FIT THESE CABLES		PANEL DIMENSIONS				PART NO.	DESCRIPTION	
	AWG/Conductors	Approximate Size	Mounting Hole Size		Thickness				
		in.	mm.	in.	mm.	in.	mm.	Black	
SV & SVT	18/2	.220	5,6	.453 x .512	11,5 x 13,0	.062	1,6	1839	ST 101A
		.245	6,2						
	18/3	.250	6,4						
HPD	18/2	.270	6,9						
	16/2	.290	7,4						

Standard color black. Consult Heyco for white and other colors.

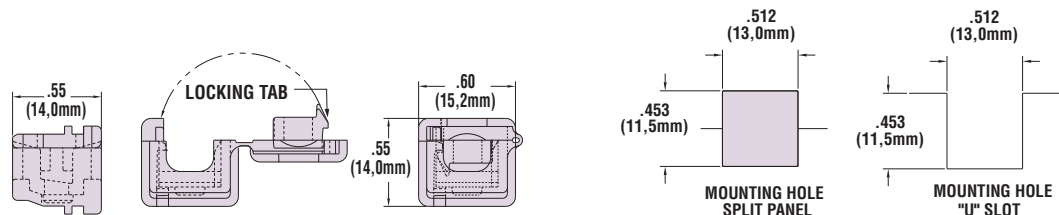

Quick Specs

Material	Nylon 6/6
Certifications	UL Recognized under the Component Program of Underwriters' Laboratories File E15331
	CS Canadian Certified by Canadian Standards Association File 8919
Flammability Rating	94V-2
Temperature Range	-.04°F (-18°C) to 221°F (105°C)

“Stay Connected” with



Strain Relief Bushings

a PennEngineering® Company



Heyco® Split Panel Strain Relief Bushings

For Split Panel Mounting Holes

WILL FIT THESE CABLES				PANEL DIMENSIONS				PART NO.	DESC.	BODY LENGTH	
UL Type	AWG/ Conductors	Approximate Size		Mounting Hole Size		Maximum Panel Thickness				Black	in.
SO	14/4	.560	14,2	.825	21,0	.062	1,6	1263	SR 8R-2	.670	17,0
SO	12/3	.590	15,0								
Round, Flat or Multiple	Multiple	up to .600	up to 15,2	.875x.875	22,2x22,2	.100	2,5	1266	SR 8R-200	.800	20,3

Standard color black. Consult Heyco for white and other colors

PN 1263

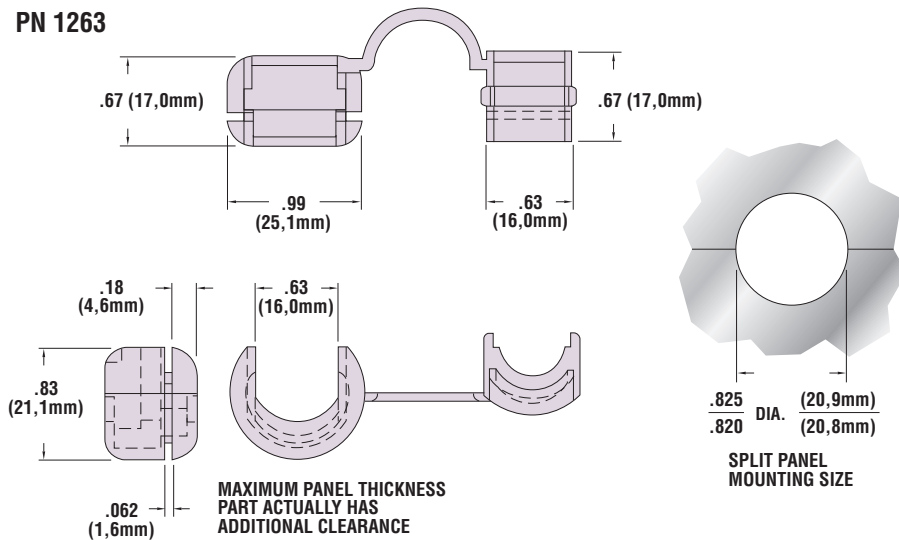

PN 1266

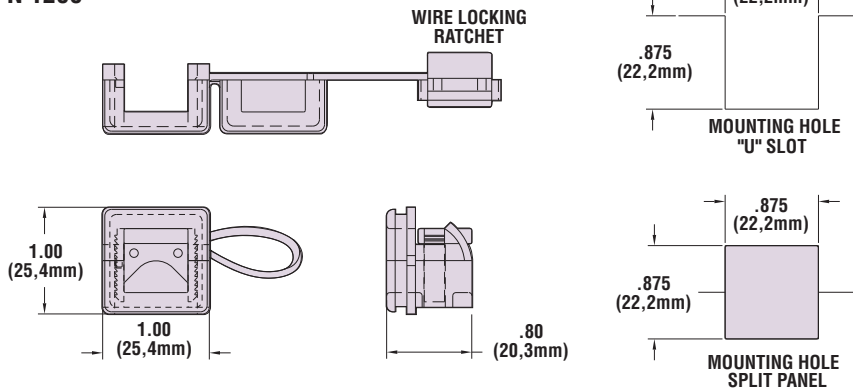

- Designed to be installed in a split panel mounting hole or dropped into a slot.
- Can be used for one wire or bundles of wire (round or flat wire).
- Securely anchors, insulates, and protects wire at panel entry points against forces of pull, push, or twist.
- Part 1266 is assembly friendly and self-locks onto the wire. It may be preassembled offline for final assembly at a later time or remote location, for lower installed cost and faster assembly. It has a unique wire locking ratchet that allows for generous wire range from .250" (6,4 mm) to .600" (15,2 mm).
- Part 1266 UL recognized for multiple cables/conductors.



PN 1263

Material

Nylon 6/6

Certifications

Recognized under the Component Program of Underwriters' Laboratories File E15331

Certified by Canadian Standards Association File 8919

Flammability Rating

94V-2

Temperature Range

-.04°F (-18°C) to 221°F (105°C)

Quick Specs

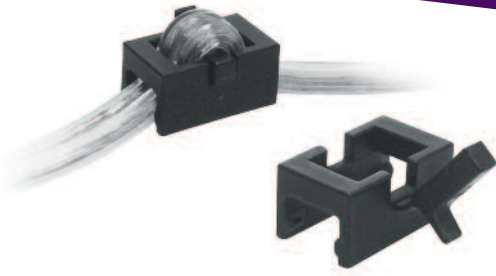

Heyco® In-Line Strain Relief Bushing

- Quick and easy to secure on any SPT-2 wire.
- Cost effective. No cutting or tools needed as with metal clamp type strain reliefs. There is no risk of repetitive motion strain or injury.
- UL Recognized (far exceeds UL's 35# pull-out test).
- UL Approved for use with SPT-2 Wire.
- Replaces UL Knot method of providing strain relief.

WILL FIT THESE CABLES				PART DIMENSIONS								PART NO. Black	DESCRIPTION
UL Type	AWG/ Conductors	Approximate Size		A		B		C		D			
		in.	mm.	in.	mm.	in.	mm.	in.	mm.	in.	mm.		
SPT-2	18/2	.150 x .280	3,8 x 7,1	.41	10,4	.70	17,8	.29	7,4	.35	8,9	1854	ISR 14-27

Standard color black. Consult Heyco for white and other colors.
No panel required for application.

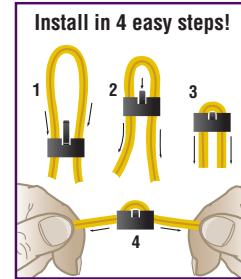
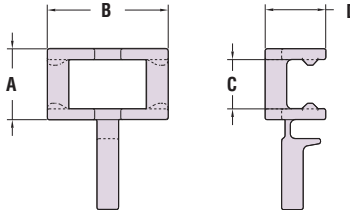

Heyco® Strain Relief Bushings LabKit #1 (Part No. 1999)

Use Heyco LabKits!



- Heyco LabKits are perfect for product design departments, experimental labs, and for all prototype work.
- Heyco LabKit #1 contains an assortment of our most popular Strain Relief Bushings.
- Heyco also offers lab kits for Liquid Tight Cordgrips, Bushings, Hole Plugs, HEYware, and Grommets.



*Quick
Specs*

Material
Certifications

Flammability Rating
Temperature Range

Nylon 6/6
 Recognized under Underwriters' Laboratories File E15331 (SRs Only)
 Certified by the Canadian Standards Association File 8919 (SRs Only)
 94V-2
 -.04°F (-18°C) to 221°F (105°C)

“Stay Connected” with



Strain Relief Bushings

a PennEngineering® Company

Heyco® Euro Strain Relief Bushings

CEE Series

WILL FIT THESE CABLES Cross Section	Approximate Diameter		PANEL DIMENSIONS				PART NO.	DESCRIPTION	B Body Length	
	in.	mm.	A Mounting Hole Dia.		Maximum Panel Thickness				Black	in.
Round	.300	7,6	.625	15,9	.125	3,2	3772	SR 6P10 CEE	.671	17,0
Round	.325-.360	8,3-9,1	.625	15,9	.125	3,2	3776	SR 6P30 CEE	.625	15,9

Standard color black. Consult Heyco for white and other colors.

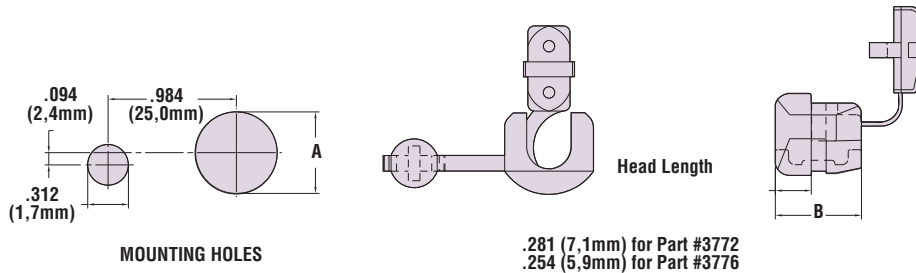

For European Requirements

Designed to meet those requirements wherein the Strain Relief device must remain attached to the panel during cable removal or replacement.

- Button lock, flexibly connected to the bushing, mounts into a hole alongside the bushing.
- Button lock secures the bushing to the panel during cable removal or replacement.



Heyco® T-Bar



- **Part No. 3791**, T-bar available in **black only**.
- During cable removal or replacement, the T-Bar prevents complete removal of the strain relief bushing from the panel, reducing the risk of losing the bushing.
- For use in mounting holes .625" (16,0 mm) and smaller.
- Snap T-Bar onto the strain relief bushing strap (linking body to key piece), then feed it into the panel mounting hole.

Material

Nylon 6/6

Certifications



Recognized under Underwriters' Laboratories File E15331 (SRs Only)

Certified by the Canadian Standards Association File 8919 (SRs Only)

Flammability Rating

94V-2

Temperature Range

-.04°F (-18°C) to 221°F (105°C)

Quick Specs

“Stay Connected” with



Strain Relief Bushings

a PennEngineering® Company



- Extra pull-out resistance
- For Heyco Liquid Tight Clamping Cordgrips, see page 3-45.
- Locknuts not included. For metal locknut specifications or to order locknuts separately, see page 3-48.

Heyco® Brass Clamping Strain Reliefs

CABLE DIAMETER RANGE				PART NO.	THREAD SIZE	PART DIMENSIONS							
Minimum		Maximum				A Clearance Hole Dia.		B Max. O.A. Length		C Thread Length		D Wrenching Flat Size	
in.	mm.	in.	mm.			in.	mm.	in.	mm.	in.	mm.	in.	mm.
PG Hubs													
.157	4,0	.315	8,0	14875	PG7	.492	12,5	.59	15,0	.24	6,0	.67	17
.236	6,0	.394	10,0	14876	PG9	.598	15,2	.67	17,0	.24	6,0	.79	20
.236	6,0	.472	12,0	14877	PG11	.732	18,6	.67	17,0	.24	6,0	.87	22
.276	7,0	.591	15,0	14878	PG13	.827	21,0	.71	18,0	.28	7,0	.94	24
.354	9,0	.669	17,0	14879	PG16	.886	22,5	.75	19,0	.28	7,0	1.06	27
.472	12,0	.866	22,0	14880	PG21	1.114	28,3	.87	22,0	.31	8,0	1.38	35
.709	18,0	1.181	30,0	14881	PG29	1.469	37,3	.91	23,0	.31	8,0	1.65	42
.945	24,0	1.417	36,0	14882	PG36	1.874	47,6	1.10	28,0	.39	10,0	2.17	55
Metric Hubs													
.197	5,0	.315	8,0	14884	M12 x 1,5	.472	12,0	.79	20,0	.39	10,0	.63	16
.236	6,0	.413	10,5	14885	M16 x 1,5	.630	16,0	.83	21,0	.39	10,0	.75	19
.315	8,0	.591	15,0	14886	M20 x 1,5	.787	20,0	.87	22,0	.39	10,0	.94	24
.492	12,5	.807	20,5	14887	M25 x 1,5	.984	25,0	.94	24,0	.43	11,0	1.18	30
.669	17,0	1.004	25,5	14888	M32 x 1,5	1.260	32,0	1.10	28,0	.51	13,0	1.42	36
.945	24,0	1.299	33,0	14889	M40 x 1,5	1.575	40,0	1.18	30,0	.51	13,0	1.81	46

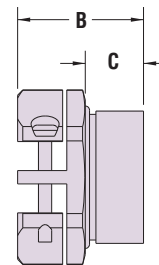
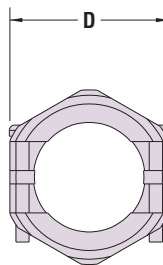

Quick Specs

Material: Nickel-Plated Brass body with Stainless Steel screws
 Temperature Rating: -58°F (-50°C) to 572°F (300°C)
 IP Rating: IP 20



3043

Heyco® Zinc Die-Cast Box Connectors

TRADE SIZE	NOMINAL MOUNTING HOLE DIAMETER		WILL FIT THESE CABLES* Flexible Metallic Conduit	Non-Metallic Sheathed		PART NO.	DESCRIPTION	PART DIMENSIONS					
	in.	mm.		Armored ***	Non-Metallic Sheathed			A		B		Overall Length	
								Minimum Wire	Maximum Wire	in.	mm.	in.	mm.
Clamp-Type Connector													
3/8**	.875	22,2	–	14/2, 14/3, 12/2, 12/3, 10/2, 10/3	14/2, 12/2, 12/3	3043	751 aka Romex® Connector	.18	4,6	.64	16,3	.81	20,6
90° Angle Connectors													
3/8**	.875	22,2	3/8	14/2, 14/3, 14/4, 12/2, 12/3, 12/4, 10/2, 8/1, 6/1, 4/1	–	3030	561	.45	11,4	.63	16,0	1.81	46,0
1/2	.875	22,2	1/2	8/2	–	3031	563	.65	16,5	.97	24,6	2.05	52,1
Combination Connectors													
3/8**	.875	22,2	3/8	14/2, 14/3, 14/4, 12/2, 12/3, 12/4	14/2, 14/3, 12/2, 12/3	3029	551	.35	9,0	.43	11,0	.79	20,0
						3040	551 No Nut						
Box Connector													
1/2	.875	22,2	n/a	n/a	n/a	9840	SP1	.40	10,2	1.12	28,4	.31	7,9

*Gauge/Conductors, except FMC.
 **1/2" K.O.
 ***Not UL Rated for armored cable.

Part No. 3043 (751) commonly known as a Romex® Connector.

- Also fits corrugated MC at .51" (13,0 mm) diameter, smooth MC at .35" (8,8 mm) to .53" (13,3 mm) diameter.
- DFARS Compliant
- For Heyco Liquid Tight Romex Connectors, see page 3-16.



9840

- Provides a connecting link between boxes, panels or chassis.
- Space boxes 5/16" (7,9 mm) apart.
- Die-cast locknut included.
- DFARS Compliant

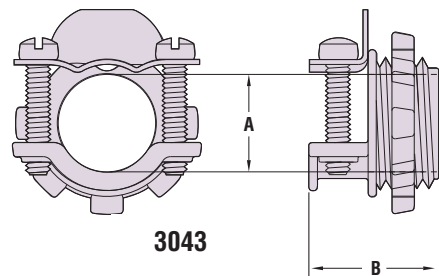

3043

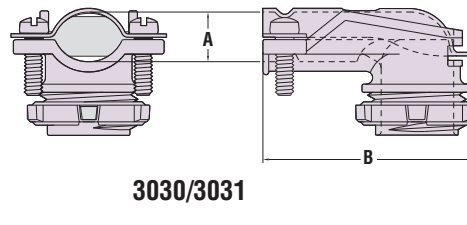

3030/3031

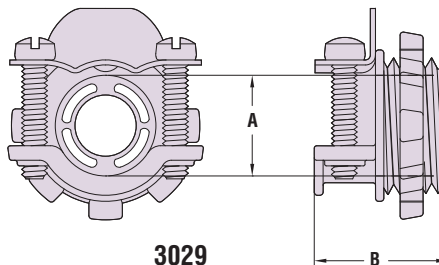

3029

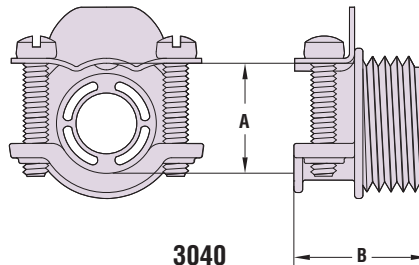

3040

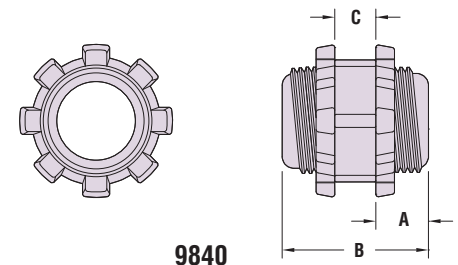

9840

Material: Zamak 3
 Certifications: Listed under Underwriters' Laboratories File E103541
 Certified by the Canadian Standards Association File 88539

Quick Specs

“Stay Connected” with



Strain Relief Bushings

a PennEngineering® Company



- Convert trade size knock-out holes to diameters suitable for strain relief bushings.
- Allow for standardization of panel design since various strain relief bushing sizes can be adapted to one panel hole size.
- Allow for the mounting of strain relief bushings into unusually thick panel.
- Adapters mount into 1/2" knock-outs (7/8" or 22,2 mm nominal diameter).
- Made of zinc-plated steel.
- For Heyco Knock-Out Seals, see page 6-35.
- DFARS Compliant

Heyco® Knock-Out Adapters for Strain Relief Bushings

Will Adapt These Strain Reliefs to Fit an .875 (22,2mm.) Diameter Hole.	PART NO.	DESCRIPTION	LUG LENGTH	
			in.	mm.
4K-1, 4K-4, 4K-6, 4L-1 4L-4, 5L-1, 5P3-4, 5P-4, 5P-7, 5S-1, 6W-1, 14-1, 15-1, 5M-3	7562	A-22F	.500	12,7
6K-5, 6L-1, 6P2-5, 6P3-4 6P3-5, 6P3-7, 6P-4, 6P-5 6P-7, 10-2, 11-2, 11K-2	7567	A-25F	.500	12,7
5K-4, 5W-1, 16-1	7570	A-28F	.500	12,7
20-1, 20L-1, 30-1	7572	A-41	.500	12,7



A-10

A-10 Adapter Pliers (Part #0024)

For quick and easy locking of adapters.

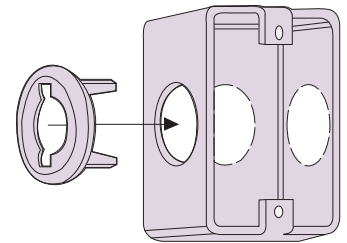
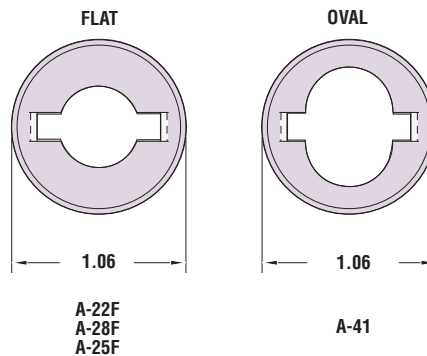

- For situations where the panel is too flexible to support UL's 35# strain relief pull-out test.
- OR for situations where the panel is thin relative to the strain relief's locking slot. The backup washer eliminates play.
- OR can be used to contain the strain relief bushing in U-slot openings.
- Used together with our Strain Relief Bushings.
- Made of zinc-plated steel.
- DFARS Compliant

Heyco® Back-Up Washer for Strain Relief Bushings

PART NO.	DESCRIPTION	INSIDE DIAMETER		OUTSIDE DIAMETER		THICKNESS	
		in.	mm.	in.	mm.	in.	mm.
7592	SRW 500	.500	12,7	.625	15,9	.025	0,6

“Stay Connected” with



Strain Relief Bushings

a PennEngineering® Company



Heyco® Strain Relief Mounting Hole Plugs

Multiple Panel Thickness Design

Maximum Thickness		PANEL DIMENSIONS				PART NO.	DESCRIPTION	PART DIMENSIONS			
		D Mounting Hole Diameter		C To Prevent Rotation				A Head Diameter		B Overall Height	
in.	mm.	in.	mm.	in.	mm.	Black		in.	mm.	in.	mm.
For Double D Mounting Hole Strain Reliefs											
.125	3,2	.375	9,5	.345	8,8	2617	DP 375*	.468	11,9	.406	10,3
		.437	11,1	.390	9,9	2488	DD 437-390	.531	13,5		
		.500	12,7	.445	11,3	2491	DD 500-445	.554	14,7		
.125	3,2	.562	14,3	.530	13,5	2494	DD 562-530	.656	16,7	.406	10,3
		.625	15,9	.550	14,0	2497	DD 625-550	.728	18,5		
		.750	19,1	.625	15,9	2503	DD 750-625	.921	23,4		
.125	3,2	.875	22,2	.770	19,5	2509	DD 875-770	1.016	25,8	.453	11,5
		1.109	28,2	1.000	25,4	2717	DD 1109-1000	1.218	30,9		
.125	3,2	2.000	50,8	1.875	47,6	2959	DD 2000-1875	2.170	55,1	.478	12,1
For Lockit ST-Series, Rectangular Mounting Hole Strain Reliefs**											
.099	2,5	.512	13,0	.453	11,5	1890†	RP 115-130	.580	14,7	.403	10,2
.157	4,0	.690	17,5	.690	17,5	1892	RP 175-175	.830	21,1	.470	11,9

Standard color black. Consult Heyco for white and other colors.

*On installation, DP 375 Locking Fingers must be aligned with Mounting Hole Flats.

**Rectangular Plugs locking finger steps match those of the corresponding ST Lockit Strain Reliefs.

†PN 1890 is not CSA certified.

- Closes unused strain relief mounting holes or Double D holes punched or molded with two opposing flats.
- Convex, matte finish head tapers to a thin edge.
- Quick and easy installation.
- Locks firmly in panels up to .157" (4,0 mm) thick.
- Use our rectangular plugs #1890 and #1892 to fill unneeded square Lockit™ Strain Relief mounting holes.
- Approximate Head Thickness: .063" (1,6 mm). Thickness may vary.
- For Double D Mounting Hole Punches, see page 4-30.

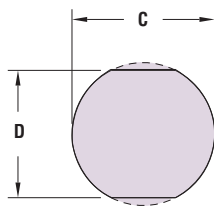

“DOUBLE D”
MOUNTING HOLE

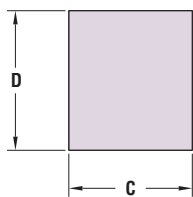
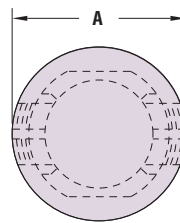
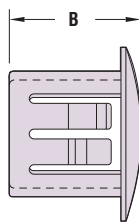

MOUNTING HOLE

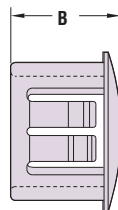

PART NUMBERS 1890/1891

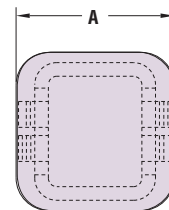

1890, 1892

Material

Nylon 6/6

Certifications



Recognized under the Component Program of Underwriters' Laboratories File E51579



Certified by the Canadian Standards Association File 8919

Flammability Rating

94V-2

Temperature Range

-04°F (-18°C) to 221°F (105°C)

Quick
Specs

How to Choose a Heyco® Strain Relief - *and Make the Right Choice:*

To specify a Strain Relief and get the best fit, ask yourself the following 4 questions:

1. Is my wire or wire harness Round or Flat?

Most Heyco Strain Relief tabular charts are segregated into For Round Cables and For Flat Cables.

2. What is my wire or wire harness Diameter or Dimensions?

Heyco Strain Relief charts are typically sequenced by Wire Size / Mounting Hole Size.

3. What is my panel Thickness?

A. Lockit Strain Reliefs - Multiple Locking Step Fingers provide a Finished Fit across a wide spectrum of Panel Thicknesses

B. Original Strain Reliefs - the Maximum Panel Thickness provides the best Finished Fit.

4. What Functionality and Assembly method do I need?

Heyco Strain Relief tabular charts are segregated by Functionality and ease of Assembly.

For The Ultimate in Snap-in Strain Relief Protection:

Page

A. Snap-in Cordgrip Strain Reliefs – Straight-thru

4-1

Snap-in Cordgrip Strain Reliefs – Pigtail

4-2

B. Lockit™ Strain Reliefs - Snap-onto-cable Pre-Assemble by Hand Tool or Semi-Automatic Equipment

For Faster Final Assembly - Semi-Automated Equipment Available

4-5 thru 4-16

1. ST Lockit Strain Reliefs - Straight-thru for Rectangular Mounting Holes

4-5 thru 4-6

2. RDD Lockit Strain Reliefs - for Double D Mounting Holes

a. 35lb. Pull Test

Straight-thru

4-7 thru 4-11

b. 35lb. Pull with Maximum Flex-protection

Pigtail

4-12

c. 35lb. Pull with 90 degree exit from Panel

Right Angle

4-13 thru 4-14

3. Specialty Strain Reliefs for Multiple Conductors, Split Panels

4-31 thru 4-32

4. Universal and Romex® Strain Reliefs - widest range, snap into panel

4-3

5. Removable Snap-in Ratcheting Strain Reliefs - widest range, snap into panel

4-4

6. Mounting Hole Plugs - Standardize Panel Design!

4-38

C. Original Strain Reliefs - Assemble by Air Tool or Hand Pliers

4-27 thru 4-29

a. 35lb. Pull Test

Straight-thru

4-17 thru 4-21

b. 35lb. Pull with minimum Flex-protection

Internal Radii

4-22

c. 35lb. Pull with Flex-protection

Bell-Mouth

4-23

d. 35lb. Pull with maximum Flex-protection

Pigtail

4-24

e. 35lb. Pull with 90 degree exit from Panel

Right Angle

4-25 thru 4-26

f. In-line Lampcord Strain Relief

Replaces UL Knot

4-33

g. European Requirements

CEE

4-34

h. Metal Strain Reliefs and Accessories

4-30, 4-37

i. Brass Clamping Strain Reliefs

Clamping Connectors

4-35

j. Zinc Die-Cast Box Connectors

Box Connectors

4-36

For a quick and easy "one screen summary," visit our Strain Relief Selector Guide web app at www.Heyco.com



5-1 Heyco Vent Plugs & Thick Panel Vent Plugs



5-2 HEYClean Filter Insert Vent Plugs



5-3 Heyco Louvered Plugs



5-3 HEYClean Filter Insert Louvered Plugs



5-4 Heyco Threaded Vent Plugs



5-5 HEYClean Liquid Tight Threaded & Snap-In Vent Plugs



5-6 HEYClean Brass Pressure Equalization & Drain Plugs



5-6 HEYClean Drain Plug Brass Locknuts



5-7 Heyco Fan Guards



5-7 Heyco Fan Guard Rivets



5-8 Heyco Fan Mounts

The Strain Reliever™ “Pill Bottle” (PN 9977)



INDICATIONS:

For permanent **relief of strain** associated with not having the solution.

DIRECTIONS:

Remove top and shake out a potential solution. Take one dose each time “**no solution**” symptoms appear. Repeat as needed. This prescription may be refilled at any time because new solutions are constantly being generated.

WARNING:

If strain persists or gets worse, consult your Heyco representative immediately because this could be a sign of a serious problem in need of a Heyco solution!

Request one from your Heyco Distributor, Sales Representative, Business Development Manager, or Customer Service Representative—TODAY!

HEYCO FOR YOUR BUSINESS HEALTH



- Permit the passage of air for ventilation and heat dissipation.
- Quick and easy installation with only fingertip pressure.
- Convex, matte finish head tapers to a thin edge.
- VP-500 through VP-875 have .094" (2,4 mm) diameter vent holes. All other sizes have .125" (3,2 mm) diameter vents.
- Lock firmly into panel up to .250" (6,4 mm) thick.
- Locking fingers in fractional increments up to the maximum panel thickness.
- Multiple sizes for use in .500" (12,7 mm) to 4.000" (101,6 mm) diameter holes.
- Approximate Head Thickness: .062" (1,6 mm). Thickness may vary.
- Heyco Louvered Plugs available, see page 5-3.

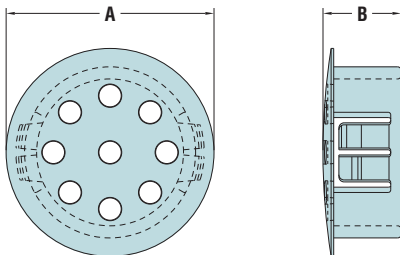

Heyco® Vent Plugs and Thick Panel Vent Plugs

Mounting Hole Diameter Range: .500" (12,7 mm) to 4.000" (101,6 mm)

MOUNTING HOLE DIAMETER		PART NO.		DESCRIPTION	No. of Vent Holes	PART DIMENSIONS A		B	
in.	mm.	Black	White			Head Diameter in.	mm.	Overall Height in.	mm.

Multiple Locking Steps for Panel Thickness up to .125" (3,2 mm)

.500	12,7	2637	2638	VP 500	4	.56	14,2	.41	10,3
.562	14,3	2647	-	VP 562	4	.66	16,7		
.625	15,9	2657	2658	VP 625	5	.73	18,7		
.750	19,1	2677	2678	VP 750	8	.91	23,0		
.812	20,6	2688	2689	VP 812	8	.89	22,6	.45	11,5
.875	22,2	2697	2698	VP 875	9	1.02	25,8		
1.000	25,4	2707	2708	VP 1000	9	1.20	30,6		
1.093 - 1.125	27,8 - 28,6	2726	2727	VP 1093	9	1.22	30,9		
1.187	30,1	2736	2737	VP 1187	10	1.31	33,3	1.38	34,9
1.250	31,7	2743	2744	VP 1250	10	1.38	34,9		
		2797	-	SVP 1250-4	4				
1.375	34,9	2756	2757	VP 1375	11	1.50	38,1	.47	11,9
1.500	38,1	2766	2767	VP 1500	13	1.67	42,4		
1.750	44,5	2776	2777	VP 1750	13	1.91	48,4		
2.000	50,8	2786	2787	VP 2000	19	2.14	54,4		

Multiple Locking Steps for Panel Thickness up to .250" (6,4 mm)

.500	12,7	3010	3011	VPT 500	4	.58	14,7	.56	14,3
.625	15,9	3013	3014	VPT 625	5	.73	18,7		
.750	19,1	2426	2427	VPT 750	8	.91	23,0		
.875	22,2	3152	3153	VPT 875	9	1.02	25,8		
1.000	25,4	3154	3155	VPT 1000	9	1.20	30,6	.58	14,7
1.093 - 1.125	27,8 - 28,6	3032	3033	VPT 1093	9	1.22	30,9		
1.187	30,1	3160	3161	VPT 1187	10	1.31	33,3		
1.250	31,7	3034	3035	VPT 1250	10	1.38	34,9		
1.375	34,9	3036	3037	VPT 1375	11	1.50	38,1	.75	19,1
1.500	38,1	3156	3157	VPT 1500	13	1.67	42,4		
1.750	44,5	3038	3039	VPT 1750	13	1.91	48,4		
2.000	50,8	3158	3159	VPT 2000	19	2.14	54,4	.74	18,8
2.500	63,5	2793	2794	VP 2.5	19	2.72	69,0		
3.000	76,2	2458	2459	VP 3.0	26	3.15	80,0		
3.500	88,9	2467	2468	VP 3.5	38	3.66	92,9	.75	19,1
4.000	101,6	2476	2477	VP 4.0	48	4.16	105,6		

Standard color black. Consult Heyco for other colors.

Quick Specs

Material	Nylon 6/6
Certifications	Recognized under the Component Program of Underwriters' Laboratories, File E51579 Certified by Canadian Standards Association, File 8919
Flammability Rating	94V-2
Temperature Range	-40°F (-40°C) to 221°F (105°C)



HEYClean™ Filter Insert Vent Plugs

Mounting Hole Diameter Range: .500" (12,7 mm) to 3.000" (76,2 mm)

MOUNTING HOLE DIAMETER		PART NO.	DESCRIPTION	No. of Vent Holes	PART DIMENSIONS			
in.	mm.				Black	A Head Diameter	B Overall Height	
		Multiple Locking Steps for Panel Thickness up to .125" (3,2 mm)						
.500	12,7	4917	FIVP 500	4	.56	14,2	.41	10,4
.875	22,2	4919	FIVP 875	9	1.02	25,8	.45	11,5
1.000	25,4	4921	FIVP 1000	9	1.20	30,6		
1.093 - 1.125	27,8 - 28,6	4923	FIVP 1093	9	1.22	30,9		
1.375	34,9	4931	FIVP 1375	11	1.50	38,1	.47	11,9
1.500	38,1	4933	FIVP 1500	13	1.67	42,4		
2.000	50,8	4937	FIVP 2000	19	2.14	54,4		
		Multiple Locking Steps for Panel Thickness up to .250" (6,4 mm)						
.875	22,2	4973	FIVPT 875	9	1.02	25,8	.56	14,3
1.000	25,4	4975	FIVPT 1000	9	1.20	30,6		
1.093 - 1.125	27,8 - 28,6	4977	FIVPT 1093	9	1.22	30,9		
1.375	34,9	4983	FIVPT 1375	11	1.50	38,1	.58	14,7
1.500	38,1	4985	FIVPT 1500	13	1.67	42,4		
2.000	50,8	4989	FIVPT 2000	19	2.14	54,4	.75	19,1
2.500	63,5	4939	FIVP 2.5	19	2.72	69,0	.74	18,8
3.000	76,2	4941	FIVP 3.0	26	3.15	80,0		

Standard color black. Consult Heyco for other colors.

- Filter inserts permit the passage of air for ventilation but limit liquid as well as dust and pest infiltration.
- Polyurethane foam filter will filter particle sizes 30 micron and larger.
- Filter is captive in body of vent plug and uses no additional real estate inside.

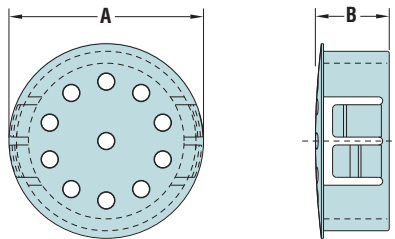
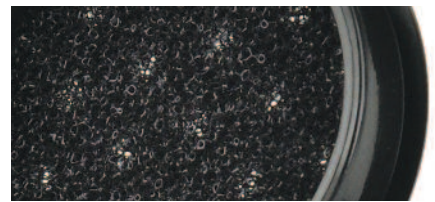

Material	Nylon 6/6
Flammability Rating	94V-2
Temperature Range	-40°F (-40°C) to 221°F (105°C)

Quick Specs



- Louvers permit the passage of air for ventilation but limit liquid infiltration.
- Suitable for ventilation in electronic enclosures, motor housings and metal or plastic panels.
- Quick and easy installation with flexible orientation of louver direction.
- Withstand a push back force of 35 lbs. (47 Nm).
- Lock firmly into panel up to .250" (6,4 mm) thick.
- Locking fingers in fractional increments up to the maximum panel thickness.
- Heyco Vent Plugs, Heyco Thick Panel Vent Plugs, and Heyco Liquid Tight Threaded Vent Plugs also available.

Heyco® Louvered Plugs

Mounting Hole Diameter Range: .875" (22,2 mm) to 3.000" (76,2 mm)

MOUNTING HOLE DIAMETER		PART NO. Black	DESCRIPTION	PART DIMENSIONS			
in.	mm.			A Head Diameter		B Overall Height	
				in.	mm.	in.	mm.
Multiple Locking Steps for Panel Thickness up to .125" (3,2 mm)							
.875	22,2	2557	LP 875	1.02	25,8	.53	13,5
1.000	25,4	2559	LP 1000	1.21	30,6		
1.093 - 1.125	27,8 - 28,6	2561	LP 1093	1.22	30,9	.54	13,8
1.375	34,9	2567	LP 1375	1.50	38,1		
1.500	38,1	2569	LP 1500	1.68	42,6		
2.000	50,8	2594	LP 2000	2.17	55,1		
Multiple Locking Steps for Panel Thickness up to .250" (6,4 mm)							
2.500	63,5	2596	LP 2.5	2.72	69,0	.82	20,9
3.000	76,2	2598	LP 3.0	3.17	80,5		

Standard color black. Consult Heyco for other colors.

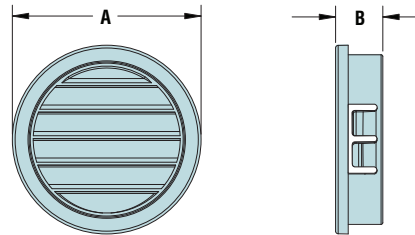

- Located behind the louvers, filter inserts permit the passage of air for ventilation but limit liquid as well as dust and pest infiltration.
- Polyurethane foam filter will filter particle sizes 30 micron and larger.

HEYClean™ Filter Insert Louvered Plugs

Mounting Hole Diameter Range: .875" (22,2 mm) to 3.000" (76,2 mm)

MOUNTING HOLE DIAMETER		PART NO. Black	DESCRIPTION	PART DIMENSIONS			
in.	mm.			A Head Diameter		B Overall Height	
				in.	mm.	in.	mm.
Multiple Locking Steps for Panel Thickness up to .125" (3,2 mm)							
.875	22,2	4947	FILP 875	1.02	25,8	.53	13,5
1.000	25,4	4949	FILP 1000	1.21	30,6		
1.093 - 1.125	27,8 - 28,6	4951	FILP 1093	1.22	30,9	.54	13,8
1.375	34,9	4957	FILP 1375	1.50	38,1		
1.500	38,1	4959	FILP 1500	1.68	42,6		
2.000	50,8	4963	FILP 2000	2.17	55,1		
Multiple Locking Steps for Panel Thickness up to .250" (6,4 mm)							
2.500	63,5	4965	FILP 2.5	2.72	69,0	.82	20,9
3.000	76,2	4967	FILP 3.0	3.17	80,5		

Standard color black. Consult Heyco for other colors.

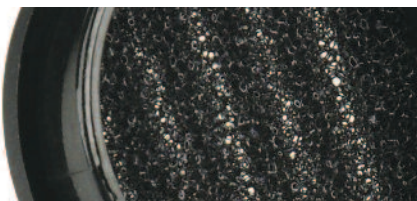

Quick
Specs

Material	Nylon 6/6
Flammability Rating	94V-2
Temperature Range	-40°F (-40°C) to 221°F (105°C)

Heyco® Threaded Vent Plugs

Open vent holes only



THREAD Type/Size	PART NO.		DESCRIPTION	PART DIMENSIONS			
	Black	Gray		A Wrenching Flats		B Overall Length	
				in.	mm.	in.	mm.
NPT							
NPT 1/4	3551B	3551	TVP NPT 1/4	.63	16,0	.66	16,8
NPT 3/8	3552B	3552	TVP NPT 3/8	.83	21,0	.69	17,5
NPT 1/2	3553B	3553	TVP NPT 1/2	.98	24,9	.81	20,6
NPT 3/4	3554B	3554	TVP NPT 3/4	1.29	32,8	.86	21,8
PG - for PG Thread specifications, see page 3-49							
Pg 7	3566B	3566	TVP Pg 7	.63	16,0	.53	13,5
Pg 9	3567B	3567	TVP Pg 9	.83	21,0		
Pg 13.5	3568B	3568	TVP Pg 13.5	.98	24,9	.62	15,8
Pg 21	3569B	3569	TVP Pg 21	1.29	32,8	.76	19,3
Metric							
M12	3557B	3557	TVP M12	.63	16,0	.53	13,5
M16	3558B	3558	TVP M16	.83	21,0		
M20	3559B	3559	TVP M20	.98	24,9	.62	15,8

Standard color Black. Consult Heyco for other colors.

- Permit the passage of air for ventilation and heat dissipation.
- Quick and easy installation into Threaded Holes.
- For multiple thread sizes and types.
- All sizes and types feature seven (7) .094" (2,4 mm) diameter vent holes.
- Threaded plugs for hydraulic and pneumatic applications.
- Lower cost option over brass or steel plugs.
- Non-corrosive-resist salt water, weak acids, gasoline, alcohol, oil, grease and common solvents. Resist oil and heat up to 221°F (105°C).
- Approximate Head Thickness: .21" (5,3 mm). Thickness may vary.
- Hex shaped head for wrench installation.
- Electrically non-conductive Nylon 6/6.
- For **Liquid Tight** Threaded Vent Plugs, see page 5-5.

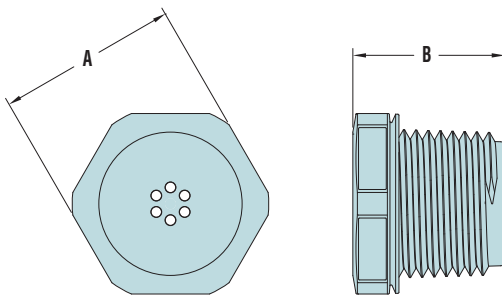

Material	Nylon 6/6 bodies with UL (f1) rating
Flammability Rating	94V-2
Temperature Range	-40°F (-40°C) to 221°F (105°C)

Quick
Specs

**NO O-RING
REQUIRED!**



HEYClean™ Liquid Tight Threaded Vent Plugs

With Integral Sealing Ring and Liquid Tight Filter

THREAD Type/Size	PART NO.		DESCRIPTION	PART DIMENSIONS			
	Black	Gray		A Wrenching Flats		B Overall Length	
				in.	mm.	in.	mm.
NPT							
NPT 1/4	3544VB	3544V	LTTVP NPT 1/4	.63	16,0	.66	16,8
NPT 3/8	3545VB	3545V	LTTVP NPT 3/8	.83	21,0	.69	17,5
NPT 1/2	3546VB	3546V	LTTVP NPT 1/2	.98	24,9	.81	20,6
NPT 3/4	3547VB*	3547V*	LTTVP NPT 3/4	1.29	32,8	.86	21,8
PG - For PG Thread specifications, see page 3-49							
Pg 7	3574VB	3574V	LTTVP Pg 7	.63	16,0	.53	13,5
Pg 9	3575VB	3575V	LTTVP Pg 9	.83	21,0		
Pg 13.5	3576VB	3576V	LTTVP Pg 13.5	.98	24,9	.62	15,8
Pg 21	3401VB	3401V	LTTVP Pg 21	1.29	32,8	.76	19,3
Metric							
M12	3582VB	3582V	LTTVP M12	.63	16,0	.53	13,5
M16	3583VB	3583V	LTTVP M16	.83	21,0		
M20	3584VB	3584V	LTTVP M20	.98	24,9	.62	15,8

Standard color Black. Consult Heyco for other colors.

*IP 65 rated.

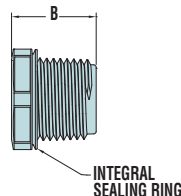
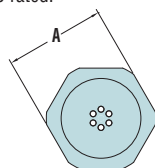

Threaded Vent Plug

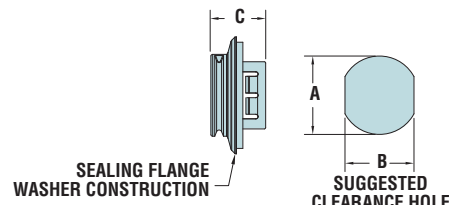

Snap-In Vent Plug

HEYClean™ Liquid Tight Snap-In Vent Plugs

With Integral Sealing Flange/Washer and Liquid Tight Filter

Mounting Hole Diameter Range: .500" (12,7 mm) to 1.125" (28,6 mm)

A Mounting Hole Dia.*	PART NO.	DESCRIPTION	PART DIMENSIONS			
			B To Prevent Rotation		C Max. O.A. Length	
			in.	mm.	in.	mm.
.500	3481VB	LTSV 500	.45	11,4	.600	15,2
.875	3486VB	LTSV 875	.77	19,6	.620	15,7
1.125	3488VB	LTSV 1125	1.00	25,4	.660	16,8

Standard color black. Consult Heyco for other colors.

* Consult Heyco for additional sizes.

Material	Nylon 6/6 bodies with an Acrylic Copolymer Filter
Certifications	Recognized under the Component Program of Underwriters' Laboratories, File E330194 to both Canadian and U.S. Requirements
Flammability Rating	94V-2
Temperature Range	-40°F (-40°C) to 221°F (105°C)
IP Rating	IP 65/67/68

Quick
Specs



HEYClean® Brass Pressure Equalization and Drain Plugs

For Pressure Equalization and Drainage Applications

THREAD Type/Size	PART NO.		DESCRIPTION	PART DIMENSIONS								PROTECTION CLASS
	STD.	EXP*		A Clearance Hole in. mm.		B Overall Length in. mm.		C Thread Length in. mm.		D Wrenching Flats in. mm.		

Liquid Tight Pressure Equalization Plugs – Ultimate in Liquid Tight Pressure Equalization

M12 x 1.5	4350	14350	BRASS LRPEP M12	.47	12,0	.69	17,5	.31	8,0	.71	18,0	IP 66,67,68
M16 x 1.5	4351	14351	BRASS LRPEP M16	.63	16,0	.71	18,0	.31	8,0	.87	22,0	
M20 x 1.5	4352	14352	BRASS LRPEP M20	.79	20,0	.71	18,0	.31	8,0	.87	22,0	

Liquid Resistant Pressure Equalization Plugs – Maximize Airflow for Extreme Pressure and Moisture Fluctuations

M12 x 1.5	4354	–	BRASS LRPEP M12	.47	12,0	.69	17,5	.31	8,0	.71	18,0	IP 55, x9K
M16 x 1.5	4355	–	BRASS LRPEP M16	.63	16,0	.71	18,0	.31	8,0	.87	22,0	
M20 x 1.5	4356	–	BRASS LRPEP M20	.79	20,0	.71	18,0	.31	8,0	.87	22,0	

Threaded Drain Plug – For Applications Where Condensation Is Expected**

M12 x 1.5	4357	–	BRASS TDP M12	.47	12,0	.77	19,5	.39	10,0	.71	18,0	IP 4x
M16 x 1.5	4358	–	BRASS TDP M16	.63	16,0	.77	19,5	.39	10,0	.71	18,0	
M20 x 1.5	4359	–	BRASS TDP M20	.79	20,0	.77	19,5	.39	10,0	.71	18,0	

Stainless Steel available. Consult Heyco.

*Certified in accordance with IECEx and ATEX

**Heyco Drainage Plug Brass Locknuts sold separately

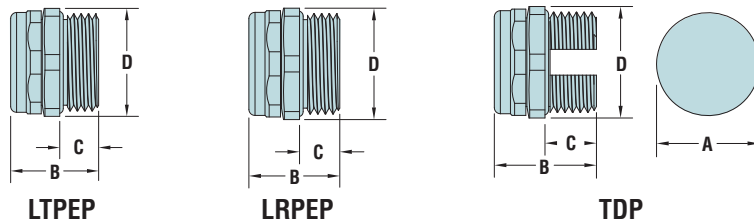

HEYClean® Drain Plug Brass Locknuts

For Use with HEYClean™ Threaded Drain Plugs

THREAD Type/Size	PART NO.	DESCRIPTION	PART DIMENSIONS			
			A Thickness in. mm.		B Wrenching Flats in. mm.	
M12 x 1.5	4360	BRASS DPLN M12	.18	4,5	.59	15,0
M16 x 1.5	4361	BRASS DPLN M16	.22	5,5	.75	19,0
M20 x 1.5	4362	BRASS DPLN M20	.22	5,5	.94	24,0

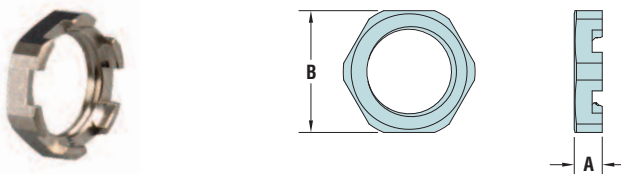

Material	Nickel-Plated Brass
Temperature Range	-40°F (-40°C) to 230°F (110°C)
IP Rating	Membrane - IP66/IP68/IP69 Filter Disc - IP55/ IPX9K Drainage Element - IP4X

Pressure Equalization Plugs

- Allow the passage of air for ventilation and heat dissipation, yet prevent moisture intrusion.
- Filter membrane prevents moisture and particulate contamination in electronic enclosures.
- Pressure compensating seal prevents buildup of pressure inside of electronic enclosures due to environmental temperature cycling.
- Quick and easy installation into Clearance or Threaded Holes.
- **Nickel-plated finish over brass provides excellent corrosion resistance and durability.**
- Head Thickness: .37" (9,5 mm) to .39" (10 mm).
- Hex shaped body for wrench installation.
- Filter element:
Liquid Tight Membrane: Polyethersulfone (PES)
Sintered Disc: Bronze
- DFARS Compliant

Drain Plugs

- Drainage Plugs are ideal for applications where condensation is expected.
 - Stainless steel mesh allows water to drain quickly, but protects enclosure from bugs and dust.
 - Drainage Plugs feature a “cutout” section to allow water to completely drain from enclosure, and should be installed at enclosure’s lowest point.
 - Head Thickness: .37" (9,5 mm) to .39" (10 mm).
 - Hex shaped body for wrench installation.
 - DFARS Compliant
- ### Drain Plug Locknuts
- Quick and easy installation into Clearance Holes only.
 - Locknuts feature special “cutout” to allow water to completely drain from enclosure, when used with HEYClean™ Threaded Drain Plugs.
 - DFARS Compliant



- Good corrosion resistance, easy to clean.
- Screw mount.
- Material: Steel wire Electroplated; Nickel Chrome finish.

Heyco® Fan Guards

NO. Rings	PART NO.	DESCRIPTION	PART DIMENSIONS								STYLE
			A		B		C		D		
			in.	mm.	in.	mm.	in.	mm.	in.	mm.	
2	0975	FG 25	.94	24,0	1.24	31,4	.12	2,2	.14	3,5	1
	0976	FG 40	1.15	29,1	1.26	32,0	.19	4,8	.16	4,0	
3	0977	FG 50	1.62	41,1	1.57	40,0	.19	4,8	.18	4,6	2
4	0978	FG 60	2.09	53,2	1.97	50,0	.17	4,4	.19	4,8	
5	0979	FG 80	2.99	76,0	2.82	71,5	.22	5,5	.19	4,8	
6	0980	FG 92	3.54	90,0	3.25	82,5	.22	5,5	.19	4,8	
8	0981	FG 120	4.55	115,6	4.13	105,0	.22	5,5	.18	4,6	3
10	0982	FG 150	6.08	154,4	6.38	162,1	.26	6,5	.19	4,8	

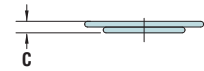
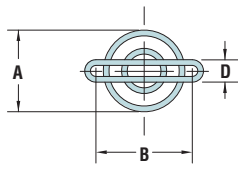

Style 1

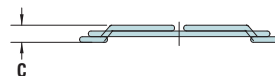
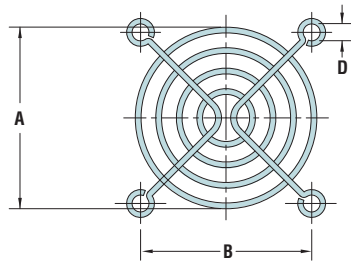

Style 2

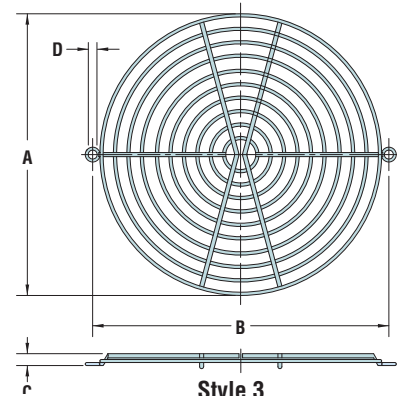

Style 3



- Permanently mount fan to chassis or finger guards to fan.
- Provide tamper resistant application.
- Prongs expand to hold securely as pin is driven.
- Single-operation front mounting saves time and money.
- Low profile head.
- Installed by hand or with installation tool.
- Part Description Key: PR/DR XXX-YYY where XXX = Mounting Hole Diameter (inches) and YYY = minimum Panel Thickness (inches).

Heyco® Fan Guard Rivets

WILL FIT THESE PANELS					PART NO. Black	DESCRIPTION	PART DIMENSIONS						EXTRACTION FORCE		
MOUNTING HOLE DIA.	PANEL THICKNESS						A Length		B Head Height		C Head Diameter		Lbs	Kg	
	in.	mm.	in.	mm.			in.	mm.	in.	mm.	in.	mm.			
Snap Style															
.124	3,1	.81	20,5	.85	21,5	9326	PR 124-807	.91	23,0	.06	1,6	.25	6,4	17,6	8
Push Style															
.137	3,5	.81	20,5	.85	21,5	9327	DR 137-807	.91	23,0	.03	0,8	.20	5,0	17,6	8

UL94V-2 Nylon 6 - both Rivets

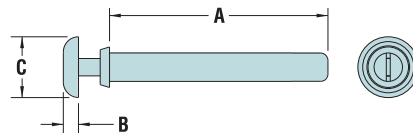

Snap Style

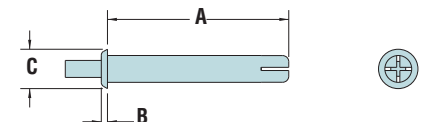

Push Style

Quick Specs

Rivets	
Material	Nylon 6/6
Flammability Rating	94V-2
Temperature Range	-4°F (-18°C) to 185°F (85°C)



Heyco® Fan Mounts

PANEL DIMENSIONS				FAN DIMENSIONS				PART	DESCRIPTION	MAT'L	PART DIMENSIONS						STYLE
Max. Panel Thickness		Mounting Hole Dia.		Mounting Hole Dia.		Thickness					A		B		C		
in.	mm.	in.	mm.	in.	mm.	in.	mm.	in.	mm.	in.	mm.	in.	mm.				
FMS - Standard																	
.055	1,4	.197	5,0	.20	5,0	.08	2,0	0345	FMS-1	EPDM 30	.06	1,5	.07	1,9	1,27	32,3	1
								0346	FMS-2	EPDM 40							
						.12	3,1	0348	FMS-3	EPDM 30	.06	1,5	.12	3,0	.87	22,2	2
								0349	FMS-4	EPDM 40							
.031	0,8	.138	3,5	.14	3,5	.79	20,0	0354	FMS-5	Silicone Rubber 40	.06	1,5	.73	18,5	2,20	56,0	3
.118	3,0	.169	4,3	.17	4,3	.59	15,0	0355	FMS-6	Silicone Rubber 40	.08	2,0	.55	14,0	2,12	53,8	
.031	0,8	.138	3,5	.14	3,5	.98-1.10	25,0-28,0	0356	FMS-7	Silicone Rubber 40	.06	1,5	.94	24,0	2,87	73,0	
FMM - Multi																	
.039-.059	1,0-1,5	.177-.189	4,5-4,8	.13-.18	3,2-4,5	.39-2,00	10,0-51,0	0357	FMM-1	Silicone Rubber 40	see schematic drawing					4	
FMB - Break-Away																	
.031-.063	0,8-1,6	.177-.197	4,5-5,0	.16-.18	4,0-4,5	.98-2,01	25,0-51,0	0359	FMB-1	Silicone Rubber 40	see schematic drawing					5	
				.13-.14	3,2-3,5	up to .40	up to 10,0				0363	FMB-2	Silicone Rubber 40	see schematic drawing			
				.16-.18	4,0-4,5	up to .98	up to 25,0										

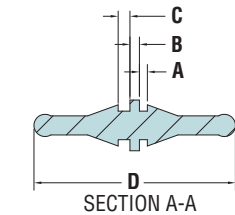

Style 1

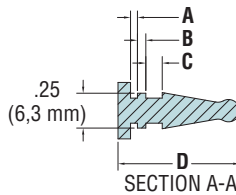

Style 2

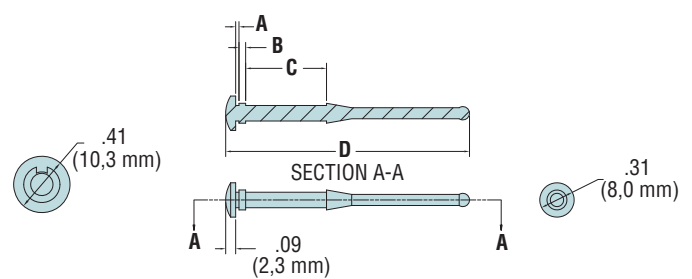

Style 3

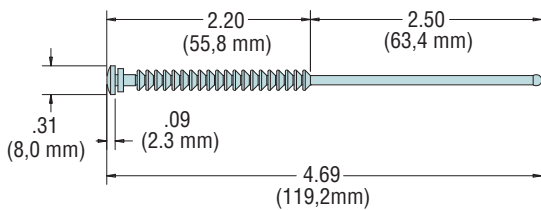

Style 4

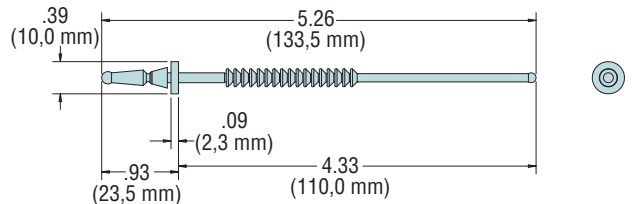

Style 5

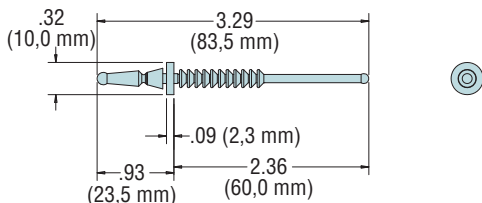

Style 6

HEYCO®
Bushings,
Grommets,
HEYCaps and
Plugs



6-1 HEYConnect Terminal Bushings

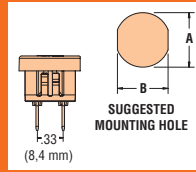

6-2 HEYConnect Terminal Bushings Schematics



6-3 Snap Bushings to .875 Diameter



6-4 Snap Bushings to 6.0 Diameter



6-5 Pry Out Bushings



6-5 UL Recognized Thermoplastic Rubber Grommets



6-6 Thick Panel & Knock-Out Snap Bushings



6-7 Thin Panel Bushings



6-8 Shorty Bushings



6-9 Metric Snap Bushings



6-9 UL Listed Thermoplastic Rubber Grommets



6-10 Snub Bushings



6-10 Sealing Washers



6-11 Universal Bushings



6-12 Shorty Universal Bushings



6-12 Thick Panel Universal Bushings



6-13 Open/Closed Universal Bushings



6-14 Open/Closed Bushings & Open/Closed Shorty Bushings



6-15 Armor Bushings



6-15 Threaded Insulating Bushing



6-16 Threaded Smooth Bore Bushings



6-16 Snap-in Smooth Bore Bushings



6-17 HEYCo-molded Liquid Tight Break-Thru (Bushings) Plugs



6-18 EPDM Snap-In Liquid Tight Bushings - Pg



6-18 EPDM Snap-In Liquid Tight Bushings - Metric



6-19 Rubber Grommets for .063 Thick Panels



6-20 Rubber Grommets for .063 to .125 Thick Panels



6-21 Rubber Grommets for .125 to .188 Thick Panels



6-22 Thick Panel Rubber Grommets for .250 & .375 Thick Panels



6-23 Continuous Grommet Rolls - Polyethylene & Nylon



6-24 Grommet Channels - TPE "DS" & Polystyrene



6-25 Dome Plugs



6-26 Large Dome Plugs & Thick Panel Dome Plugs



6-27 Shorty Plugs



6-28 Thin Panel Dome Plugs



6-29 Halogen & Phosphorus-Free 94V-0 Hole Plugs



6-30 Extra Dome Plugs



6-30 Snap-In Metric Dome Plugs



6-31 Glossy Plugs & Thick Panel Glossy Plugs



6-32 Pry Out Plugs - Standard Finger Design



6-32 Pry Out Plugs - Prong Finger Design



6-33 Metric Ergonomic Plugs



6-33 Insulation Plug



6-34 Double D & Blanking Plugs



6-35 Window "View Port" Plugs



6-35 Diffuser Plugs



6-36 Shorty & Oval "View Port" Window Plug



6-37 Knock-Out & V-0 Knock-Out Seals



6-38 Heyco V-0 Liquid Tight Hole Plugs



6-39 Nylon Liquid Tight Threaded Plugs



6-40 HEYCo-molded Liquid Tight Break-Thru Plugs



6-41 D-Subminiature HEYCaps



6-41 EMC HEYCaps



6-42 Nylon D-Subminiature Mounting Hole Plugs



6-42 IEC-14 Plug



6-43 USB and RJ HEYCaps and Plugs



6-44 Pg & Metric Threaded Plugs



6-45 Plugs for Threaded Ports - NPT, NPS, SAE & ISO



6-46 Push-In Threaded Plugs



6-46 TEMPlugs for NPT Threaded Ports



6-47 HEYCap Tapered Caps & Plugs - NPT



6-48 HEYCap Tapered Caps & Plugs - SAE



6-49 LDPE Sheet Metal Plugs - Recessed Head



6-49 Sheet Metal Plugs - Flush Head



6-50 HEYCaps for Round Tubing - CRT & PRT



6-51 Plugs for Square Tubing - PST

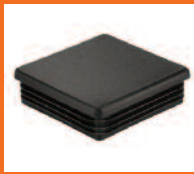

6-51 Plugs for Square Tubing - PSTR



6-52 Ergonomic Plugs for Square Tubing - PSTE



6-52 Plugs for Rectangular Tubing - PZT



6-53 Custom Engraved Tops Capability



6-53 Stock & Custom Colors Availability



Heyco® Bushings LabKit #2 Part Number 2999



Heyco® Grommets LabKit #7 Part Number 2995



Heyco® Hole Plugs #3 Part Number 2997



HEYConnect™ Terminal Bushings

Bushings with Double Male Terminals

- Small, snap-in nylon receptacles for low cost, insulated, quick connection or disconnection of your wires, through panels, housings or detachable shrouds.
- Typical uses are data processing and vending machines, motors, power supplies, and controls.
- Non-polarized HEYConnects feature 1/4" (6,4 mm) internal brass male terminals, to mate with standard 1/4" (6,4 mm) female Quick-Connects.
- Polarized HEYConnects feature 1/4" (6,4 mm) and 3/16" (4,7 mm) internal brass male terminals, to mate with standard 1/4" and 3/16" female Quick-Connects.
- Two-terminal HEYConnect bodies feature markings that correlate the terminals, front to back.
- Available in double-male and male-solder configurations.
- Rated for 300 Vac/Vdc @ 8.2 Amps.
- See schematics on page 6-2.

TERMINALS		PANEL DIMENSIONS								PART NO.	DESCRIPTION	PART DIM. D	
No. of Poles	Width	A		B		C		Black	Overall Length			in.	mm.
	in.	mm.	Mounting Hole Diameter	To Prevent Rotation	Maximum Panel Thickness	in.	mm.			in.	mm.		
Non-polarized													
1	.25	6,4	.500	12,7	.465	11,8	.125	3,2	4240	DC 50-1-M/M	.94	23,9	
									4250	DC 50-1-M/M Tinned			
1	.25	6,4	.687	17,4	.640	16,3	.125	3,2	4380	DC 68-1-M/M			
2	.25	6,4	.687	17,4	.640	16,3	.125	3,2	4440	DC 68-2-M/M			
Polarized													
1	.19	4,8	.687	17,4	.640	16,3	.125	3,2	4428	DC 68-2-M/M Polarized	.94	23,9	
1	.25	6,4											

Bushings with Tinned Male to Solder Terminals

TERMINALS		PANEL DIMENSIONS								PART NO.	DESCRIPTION	PART DIM. D	
No. of Poles	Width	A		B		C		Black	Overall Length			in.	mm.
	in.	mm.	Mounting Hole Diameter	To Prevent Rotation	Maximum Panel Thickness	in.	mm.			in.	mm.		
Non-polarized													
1	.25	6,4	.500	12,7	.465	11,8	.125	3,2	4270	DC 50-1-M/S-Tinned	.92	23,4	
1	.25	6,4	.687	17,4	.640	16,3	.125	3,2	4410	DC 68-1-M/S-Tinned			
2	.25	6,4	.687	17,4	.640	16,3	.125	3,2	4470	DC 68-2-M/S-Tinned			
Polarized													
1	.19	4,8	.687	17,4	.640	16,3	.125	3,2	4468	DC 68-2-M/S-Pol Tinned	.92	23,4	
1	.25	6,4											

Standard color black. Consult Heyco for white and other colors.



Quick Specs

Material	Polycarbonate
Certifications	Recognized under the Component Program of Underwriters' Laboratories' Laboratories File E467283 to both Canadian and US Requirements
Flammability Rating	94V-0
Temperature Range	32°F (0°C) to 266°F (130°C)

HEYConnect™ Terminal Bushings - Schematics

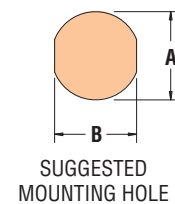
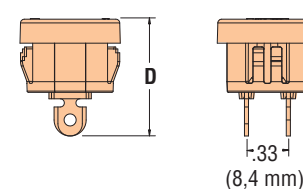
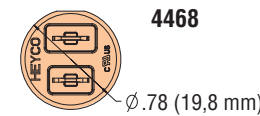
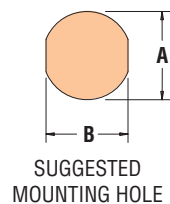
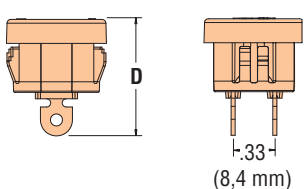
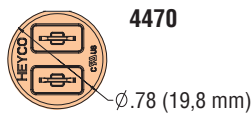
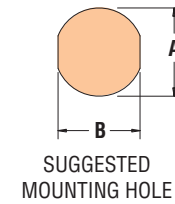
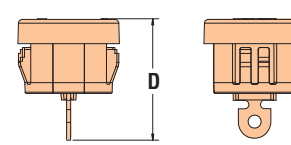
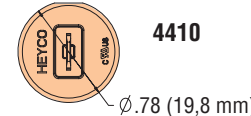
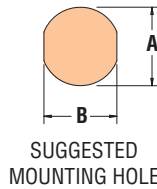
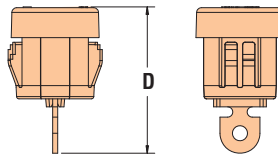
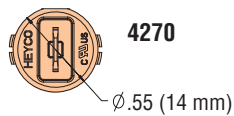
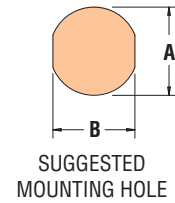
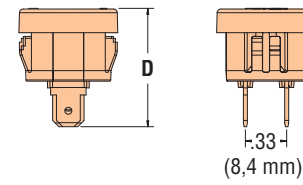
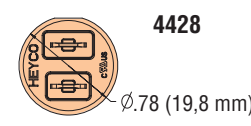
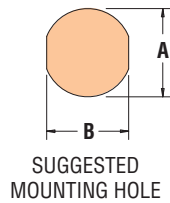
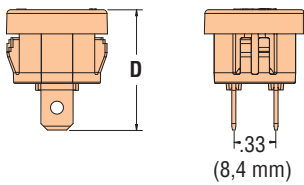
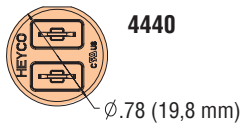
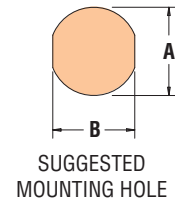
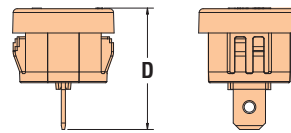
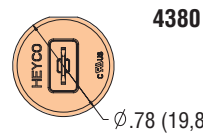
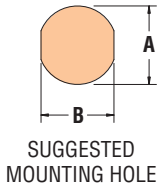
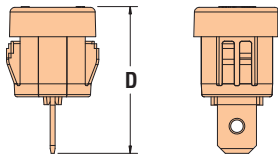
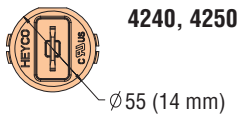



- Convert raw-edged holes to smooth, neat, insulated holes.
- Insulate and mechanically protect electrical and telecommunications cables, tubing, hose, rope, and utility lines.
- Locking fingers snap into holes with fingertip pressure.
- Locking fingers in fractional increments up to the maximum panel thickness.
- Withstand a push back force of 35 pounds.
- Available in multiple sizes for use in .250” (6,4 mm) to 6.00” (152,4 mm) diameter holes.
- We offer the following brass-colored parts for lamp and lighting applications:
Part No. 2012, SB 312-3 Brass
Part No. 2033, SB 375-4 Brass
Part No. 2041, SB 437-4 Brass

Heyco® Snap Bushings

Mounting Hole Diameter Range: .250” (6,4 mm) to .875” (22,2 mm)

MOUNTING HOLE DIAMETER		PART NO.		DESCRIPTION	PART DIMENSIONS					
in.	mm.	Black	White		A Inside Diameter		B Head Diameter		C Overall Height	
					in.	mm.	in.	mm.	in.	mm.
Single Locking Step for Panel Thickness up to .040” (1,0 mm)										
.250	6,4	2003	2004	SB 250-040	.13	3,2	.31	7,9	.31	7,9
Single Locking Step for Panel Thickness up to .062” (1,6 mm)										
.250	6,4	2000	2001	SB 250-2	.14	3,6	.31	7,9	.31	7,9
.312	7,9	2010	2011	SB 312-3	.19	4,8	.38	9,5	.31	7,9
Multiple Locking Steps for Panel Thickness up to .125” (3,2 mm)										
.375	9,5	2020	2021	SB 375-3	.19	4,8	.47	11,9	.41	10,3
		2030	2031	SB 375-4	.25	6,4				
.437	11,1	2042	2037	SB 437-243	.24	6,2	.53	13,5		
		2038	2039	SB 437-4	.27	6,8				
		2043	2044	SB 437-5	.31	7,9				
.500	12,7	2058	2059	SB 500-4	.25	6,4	.57	14,5		
		2049	2050	SB 500-5	.31	7,9				
		2053	2054	SB 500-6	.39	9,9				
.562	14,3	2060	2061	SB 562-5	.31	7,9	.66	16,7		
		2063	2064	SB 562-6	.39	9,9				
		2066	2067	SB 562-7	.44	11,1				
.625	15,9	2075	2078	SB 625-4	.25	6,4	.72	18,2		
		2070	2071	SB 625-7	.44	11,1				
		2073	2074	SB 625-8	.50	12,7				
.687	17,4	2083	2084	SB 687-8	.50	12,7	.78	19,8		
		2086	2087	SB 687-9	.56	14,3				
.750	19,1	2090	2091	SB 750-6	.39	9,9	.85	21,6		
		2092	2099	SB 750-8	.50	12,7				
		2093	2094	SB 750-9	.56	14,3				
		2096	2097	SB 750-10	.61	15,5				
.812	20,6	2100	2101	SB 812-9	.56	14,3	.89	22,6		
		2103	2104	SB 812-10	.63	15,9				
.875	22,2	2110	2111	SB 875-6	.38	9,5	.95	24,2	.45	11,5
		2113	2114	SB 875-7	.44	11,1				
		2116	2117	SB 875-8	.50	12,7				
		2120	2121	SB 875-9	.56	14,3				
		2123	2124	SB 875-10	.63	15,9				
		2126	2127	SB 875-11	.69	17,5				

Standard colors black and white. Consult Heyco for other colors.

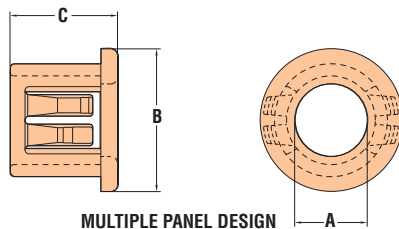
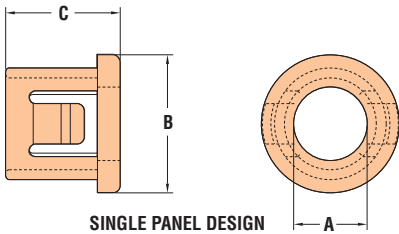

Quick Specs

Material	Nylon 6/6
Certifications	Recognized under the Component Program of Underwriters' Laboratories, File E15331 Certified by Canadian Standards Association, File 8919
Flammability Rating	94V-2
Temperature Range	-4°F (-18°C) to 221°F (105°C)

“Stay Connected” with



Bushings, Grommets, HEYcaps & Plugs

a PennEngineering® Company



Heyco® Snap Bushings

Mounting Hole Diameter Range: 1.000" (25,4 mm) to 2.500" (63,5 mm)

MOUNTING HOLE DIAMETER		PART NO.		DESCRIPTION	PART DIMENSIONS					
in.	mm.	Black	White		A Inside Diameter		B Head Diameter		C Overall Height	
					in.	mm.	in.	mm.	in.	mm.
Multiple Locking Steps for Panel Thickness up to .125" (3,2 mm)										
1.000	25,4	2140	2141	SB 1000-12	.77	19,4	1.13	28,6	.45	11,5
1.093 - 1.125	27,8 - 28,6	2160 2163 2166	2161 2164 2167	SB 1093-13 SB 1093-14 SB 1093-15	.81 .88 .94	20,6 22,2 23,8	1.22	30,9		
1.187	30,2	2182	2183	SB 1187-15	.94	23,8	1.31	33,3		
1.250	31,8	2198	2199	SB 1250-15	.94	23,8	1.36	34,5		
		2201	2202	SB 1250-16	1.00	25,4	1.31	33,3		
1.375	34,9	2207	2208	SB 1375-14	.88	22,2	1.49	37,9		
		2210	2211	SB 1375-16	1.01	25,8				
1.500	38,1	2233	2234	SB 1500-17	1.06	27,0	1.61	40,9		
		2236	2237	SB 1500-18	1.13	28,6				
		2240	2241	SB 1500-21	1.31	33,3				
1.625	41,3	2273	2274	SB 1625-21	1.31	33,3	1.74	44,2		
1.750	44,5	2300	2301	SB 1750-22	1.38	34,9	1.88	47,6		
1.875	47,6	2287	2288	SB 1875-24	1.50	38,1	2.00	50,8		
2.000	50,8	2400	2401	SB 2000-26	1.64	41,6	2.13	54,0		
		2406	2414	SB 2000-28	1.75	44,5				
Multiple Locking Steps for Panel Thickness up to .250" (6,4 mm)										
2.093	53,1	2415	2416	SB 2.093-29	1.81	46,0	2.35	59,7	.72	18,3
2.250	57,2	2417	2418	SB 2.250-29	1.86	47,1	2.48	63,1		
2.500	63,5	2420	2421	SB 2.500-31	1.97	50,0	2.66	67,5		

- Convert raw-edged holes to smooth, neat, insulated holes.
- Insulate and mechanically protect electrical and telecommunications cables, tubing, hose, rope, and utility lines.
- Locking fingers snap into holes with fingertip pressure.
- Locking fingers in fractional increments up to the maximum panel thickness.
- Withstand a push back force of 35 pounds.
- Available in multiple sizes for use in .250" (6,4 mm) to 6.00" (152,4 mm) diameter holes.
- We offer the following brass-colored parts for lamp and lighting applications:
 - Part No. 2012, SB 312-3 Brass
 - Part No. 2033, SB 375-4 Brass
 - Part No. 2041, SB 437-4 Brass

NEW!

NEW!

Standard colors black and white. Consult Heyco for other colors.

Larger 3.000" (76,2 mm) to 6.000" (152,4 mm) Diameter Parts

Small Packs Available

MOUNTING HOLE DIAMETER		PART NO.		DESCRIPTION	PACKAGING		PART DIMENSIONS					
in.	mm.	Black	White		BULK (Std)	SMALL PACK*	A Inside Diameter		B Head Diameter		C Overall Height	
						in.	mm.	in.	mm.	in.	mm.	
Multiple Locking Steps for Panel Thickness up to .250" (6,4 mm)												
3.000	76,2	2461	2462	SB 3.000-39	300	10	2.47	62,7	3.15	80,0	.75	19,1
		2424	2425	SB 3.000-44	300	5	2.75	69,9	3.16	80,2	.72	18,3
3.375	85,7	2407	2408	SB 3.375-45	400	5	2.81	71,4	3.66	93,0	.72	18,3
3.500	88,9	2470	2471	SB 3.500-47	200	5	2.94	74,7				
4.000	101,6	2479	2480	SB 4.000-55	300	5	3.47	88,1	4.15	105,4		
5.000	127,0	2409	2410	SB 5.000-70	150	1	4.38	113,8	5.22	132,6	.74	18,8
6.000	152,4	2484	2485	SB 6.000-86	130	1	5.38	139,2	6.22	157,9		

Standard colors black and white. Consult Heyco for other colors.

*Small Pack available in Black color only. To order, please add the suffix -P to Part No., e.g., 2461-P

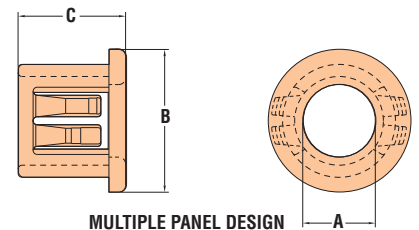

Material	Nylon 6/6
Certifications	Recognized under the Component Program of Underwriters' Laboratories, File E15331 Certified by Canadian Standards Association, File 8919
Flammability Rating	94V-2
Temperature Range	-.4°F (-18°C) to 221°F (105°C)

Quick Specs



ALL NEW PRODUCTS!

Heyco® Pry Out Bushings

Mounting Hole Diameter Range: .375" (9,5 mm) to 1.375" (34,9 mm)

- Retaining fingers without locking steps provide friction fit and allow removal of bushing.
- Insulate and mechanically protect electrical and telecommunications cables, tubing, hose, rope, and utility lines.
- Convert raw-edged holes to smooth, neat, insulated holes.
- Available in polypropylene. Consult Heyco.
- Available in multiple sizes for use in .375" (9,5 mm) to 1.375" (34,9 mm) diameter holes.

MOUNTING HOLE DIAMETER		PART NO.		DESCRIPTION	PART DIMENSIONS			
in.	mm.	Black	White		A Head Diameter		B Overall Height	
					in.	mm.	in.	mm.
Clearance Fit for Panel Thickness up to .172" (4,4 mm)								
.375	9,5	14059	14060	POB 375	.57	14,5		
.500	12,7	14065	14066	POB 500	.67	17,0		
.625	15,9	14071	14072	POB 625	.79	20,1		
.750	19,0	14077	14078	POB 750	.97	24,6	.41	10,4
.875	22,2	14083	14084	POB 875	1.05	26,7		
1.000	25,4	14086	14087	POB 1000	1.20	30,5		
1.093	27,8	14089	14090	POB 1093	1.30	33,0		
1.375	34,9	14098	14099	POB 1375	1.58	40,1	.45	11,4

Standard color black. Consult Heyco for other colors.

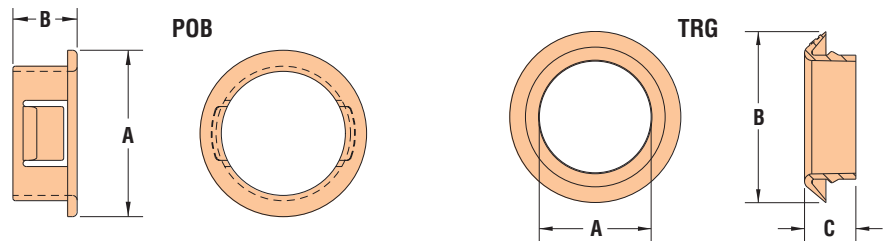

Heyco® UL Recognized Thermoplastic Rubber Grommets

Mounting Hole Diameter Range: .375" (9,5 mm) to 2.000" (50,8 mm)

ALL NEW PRODUCTS!

- Convert raw-edged holes to smooth, neat, insulated holes.
- Retaining bead snaps securely into place.
- Insulate and mechanically protect cable, tubing, hose, rope, rods, and shafts.
- UL approved for applications up to 122° F (50°C).
- Eleven diameters fit panel thickness from .03" (0,8 mm) to .13" (3,2 mm).
- Consult Heyco for custom IDs.
- For Heyco UL Listed Thermoplastic Rubber Grommets, see page 6-9.

MOUNTING HOLE DIAMETER		PART NO.	DESCRIPTION	PART DIMENSIONS					
in.	mm.	Black		A Inside Diameter		B Head Diameter		C Overall Height	
			in.	mm.	in.	mm.	in.	mm.	
For Panel Thickness from .03" (0,8 mm) to .094" (2,4 mm)									
.375	9,5	13804	TRG 375-270	.28	7,1	.70	17,8		
.500	12,7	13808	TRG 500-395	.41	10,4	.83	21,1	.36	9,1
.625	15,9	13813	TRG 625-520	.53	13,5	.95	24,1		
For Panel Thickness from .03" (0,8 mm) to .125" (3,2 mm)									
.750	19,1	13817	TRG 750-645	.66	16,8	1.07	27,2		
.875	22,2	13821	TRG 875-770	.79	20,1	1.20	30,5		
1.000	25,4	13824	TRG 1000-890	.91	23,1	1.33	33,8		
1.093	27,8	13828	TRG 1093-1000	1.01	25,7	1.42	36,1		
1.250	31,8	13831	TRG 1250-1125	1.14	29,0	1.57	39,9	.36	9,1
1.375	34,9	13833	TRG 1375-1250	1.26	32,0	1.70	43,2		
1.500	38,1	13835	TRG 1500-1375	1.39	35,3	1.83	46,5		
2.000	50,8	13840	TRG 2000-1875	1.89	48,0	2.33	59,2		

Standard color black.

Quick Specs

	POB	TRG
Material	Nylon 6/6	Flex Temp (Thermoplastic Rubber)
Certifications		Recognized under the Component Program of Underwriters' Laboratories, File E15331
Flammability Rating	94V-2	94-HB
Temperature Range	-40°F (-40°C) to 221°F (105°C)	32°F (0°C) to 122°F (50°C)



Heyco® Thick Panel Snap Bushings

Mounting Hole Diameter Range: .375" (9,5 mm) to 2.0" (50,8 mm)

MOUNTING HOLE DIAMETER		PART NO.		DESCRIPTION	PART DIMENSIONS					
in.	mm.	Black	White		A Inside Diameter		B Head Diameter		C Overall Height	
Single Locking Step for Panel Thickness up to .170" (4,3 mm)										
.375	9,5	2017	2018	SB 375-281	.28	7,1	.47	11,9	.41	10,3
1.000	25,4	3085	3088	SBT 1000-790*	.80	20,3	1.13	28,8	.45	11,4
Multiple Locking Steps for Panel Thickness up to .250" (6,4 mm)										
.500	12,7	3126	3127	SBT 500-6	.39	9,9	.58	14,7	.56	14,3
.625	15,9	2830	2831	SB 625-500**	.50	12,7	.70	17,9	.53	13,5
.750	19,1	2840	2841	SB 750-625**	.63	15,9	.83	21,0		
.875	22,2	3104	3105	SBT 875-11	.69	17,5	.95	24,2	.56	14,3
1.000	25,4	3108	3109	SBT 1000-12	.77	19,4	1.13	28,6		
1.093-1.125	27,8-28,6	3128	3129	SBT 1093-15	.94	23,8	1.22	30,9		
1.187	30,2	3130	3131	SBT 1187-15	.94	23,8	1.31	33,3		
1.250	31,8	3132	3133	SBT 1250-16	1.00	25,4	1.31	33,2		
1.375	34,9	3110	3111	SBT 1375-16	1.00	25,4	1.50	38,1		
1.500	38,1	3112	3113	SBT 1500-21	1.31	33,3	1.62	41,2		
1.750	44,5	3114	3115	SBT 1750-22	1.38	34,9	1.88	47,6		
2.000	50,8	3116	3117	SBT 2000-26	1.63	41,3	2.13	54,0		

Standard colors black and white. Consult Heyco for other colors.
 *Notched head, triple locking finger design.
 **Single Locking Step for Panel Thickness up to .250" (6,4 mm).

- For use in mounting panels up to 1/4" thick.
- Convert raw-edged holes to smooth, neat, insulated holes.
- Insulate and mechanically protect electrical and telecommunications cables, tubing, hose, rope, and utility lines.
- Locking fingers snap into holes with fingertip pressure.
- Locking fingers in fractional increments up to the maximum panel thickness.
- Withstand a push back force of >35 pounds.
- Available in multiple sizes for use in .375" (9,5 mm) to 2.000" (50,8 mm) diameter holes.

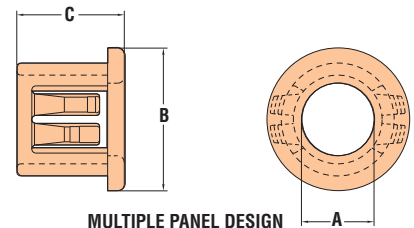

Heyco® Knock-Out Snap Bushings

For use in electrical boxes and enclosures up to thicknesses shown.

BOX HOLE DIAMETER		TRADE SIZE	PART NO. Black	DESCRIPTION	PART DIMENSIONS					
in.	mm.				A Inside Diameter		B Head Diameter		C Overall Height	
Multiple Locking Steps for Box Thickness up to .125" (3,2 mm)										
.875	22,2	1/2	2126	SB 875-11	.69	17,5	.95	24,2	.45	11,5
1.093-1.125	27,8-28,6	3/4	2166	SB 1093-15	.94	23,8	1.22	30,9		
1.375	34,9	1	2210	SB 1375-16	1.01	25,8	1.49	37,3		
1.750	44,5	1-1/4	2300	SB 1750-22	1.38	34,9	1.88	47,6		
2.000	50,8	1-1/2	2406	SB 2000-28	1.75	44,5	2.13	54,0		
Multiple Locking Steps for Box Thickness up to .250" (6,4 mm)										
2.500	63,5	2	2420	SB 2.500-31	1.97	50,0	2.66	67,5	.72	8,3

Standard color black. Consult Heyco for white and other colors. For thicker boxes, see below.

Material	Nylon 6/6
Certifications	Recognized under the Component Program of Underwriters' Laboratories, File E15331 Certified by Canadian Standards Association, File 8919
Flammability Rating	94V-2
Temperature Range	-4°F (-18°C) to 221°F (105°C)

Quick Specs



Heyco® Thin Panel Bushings

Multiple Locking Steps for Panels as Thin as .020" (0,5 mm)
 Mounting Hole Diameter Range: .218" (5,5 mm) to .875" (22,2 mm)*

- For use in panels as thin as .020" (0,5 mm).
- Convert raw-edged holes to smooth, neat, insulated holes.
- Insulate and mechanically protect electrical and telecommunications cables, tubing, hose, rope, and utility lines.
- Locking fingers snap into holes with fingertip pressure.
- Locking fingers in fractional increments up to the maximum panel thickness.
- Withstand a push back force of greater than 35 pounds.
- Available in multiple sizes for use in .218" (5,5 mm) to .875" (22,2 mm) diameter holes.

PANEL DIMENSIONS				PART NO.		DESCRIPTION	PART DIMENSIONS					
Thickness at Locking Finger Steps		Mounting Hole Diameter*		Black	White		A Inside Diameter		B Head Diameter		C Overall Height	
in.	mm.	in.	mm.				in.	mm.	in.	mm.	in.	mm.
Three Steps to .048" (1,2 mm) Thick												
.020 .032 .048	0,5	.218	5,5	2859N	2860N	B 218-125N	.13	3,2	.28	7,1	.24	6,0
		.250	6,4	2003N	2004N	B 250-187N	.19	4,7	.31	7,9		
	.281	7,1	2853N	2854N	B 281-218N	.22	5,6	.34	8,7			
	.312	7,9	2810N	2811N	B 312-250N	.25	6,3	.38	9,5			
	.343	8,7	2856N	2857N	B 343-218N	.22	5,6	.41	10,3			
.048	1,2	.375	9,5	2803N	2804N	B 375-250N	.25	6,3	.44	11,1	.25	6,4
		Five Steps to .064" (1,6 mm) Thick										
.020 .032 .040 .064	0,5	.500	12,7	2820N	2821N	B 500-375N	.38	9,5	.56	14,3	.25	6,4
		.625	15,9	2827N	2828N	B 625-500N	.50	12,7	.70	17,9		
	.750	19,1	2836N	2837N	B 750-625N	.63	15,9	.94	23,8			
	.875	22,2	2850N	2851N	B 875-750N	.75	19,0	.95	24,0			
	Standard colors black and white. Consult Heyco for other colors. *Consult Heyco for other mounting hole diameters. Our Xcell Rapid Response Team is ready to meet your requirements.											

Heyco® Thin Panel versus Shorty Bushings

Choose from Multiple Locking Steps, for the Fit and Finish Your Application Requires

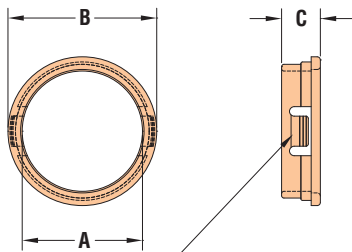

MULTIPLE FINGER STEPS FOR TIGHT, FINISHED PANEL FIT.

Mounting Hole Diameter	PANEL DIMENSIONS					PART NO.		DESCRIPTION	
	Maximum Thickness Locking Steps					Black	White		
	inches/millimeters								
in.	mm.	.020 0,5	.032 0,8	.040 1,0	.048 1,2	.064 1,6			
.218	5,5	x	x		x		2859N	2860N	B 218-125N
						x	2859	2860	B 218-125
.250	6,4	x	x		x		2003N	2004N	B 250-187N
					x		2853N	2854N	B 281-218N
.281	7,1	x	x				2853	2854	B 281-218
					x		2810N	2811N	B 312-250N
.312	7,9	x	x		x		2810	2811	B 312-250
						x	2856N	2857N	B 343-218N
.343	8,7	x	x		x		2856	2857	B 343-218
						x	2803N	2804N	B 375-250N
.375	9,5	x	x		x		2803	2804	B 375-250
						x	2820N	2821N	B 500-375N
.500	12,7	x	x	x	x		2820	2821	B 500-375
						x	2827N	2828N	B 625-500N
.625	12,7	x	x	x	x		2827	2828	B 625-500
						x	2836N	2837N	B 750-625N
.750	19,1	x	x	x	x		2836	2837	B 750-625
						x	2850N	2851N	B 875-750N
.875	22,2	x	x	x	x		2850	2851	B 875-750
						x			

Material: Nylon 6/6
 Certifications: Recognized under the Component Program of Underwriters' Laboratories, File E15331
 Certified by Canadian Standards Association, File 8919
 Flammability Rating: 94V-2
 Temperature Range: -4°F (-18°C) to 221°F (105°C)

Quick Specs

“Stay Connected” with



Bushings, Grommets, HEYcaps & Plugs

a PennEngineering® Company



Heyco® Shorty Bushings

Single Locking Step for Panel Thickness up to .062" (1,6 mm)
Mounting Hole Diameter Range: .187" (4,7 mm) to 1.093" (27,8 mm)

MOUNTING HOLE DIAMETER		PART NO.		DESCRIPTION	PART DIMENSIONS				C Overall Height	
in.	mm.	Black	White		A Inside Diameter		B Head Diameter		in.	mm.
.187	4,7	2800	2801	B 187-125	.13	3,2	.25	6,4	.24	6,0
.218	5,5	2859	2860	B 218-125	.13	3,2	.28	7,1		
.281	7,1	2853	2854	B 281-218	.22	5,5	.34	8,7		
NEW! .307	7,8	2808	2809	B 307-244	.24	6,2	.38	9,7		
.312	7,9	2810	2811	B 312-250	.25	6,3	.38	9,7		
.343	8,7	2856	2857	B 343-218	.22	5,5	.41	10,3	.25	6,4
.375	9,5	2803	2804	B 375-250	.25	6,3	.44	11,1		
NEW! .390	9,9	2815	2816	B 390-265	.27	6,7	.43	10,9		
.406	10,3	2806	2807	B 406-281	.28	7,1	.47	11,9		
.437	11,1	2813	2814	B 437-312	.31	7,9	.50	12,7		
.468	11,9	2817	2818	B 468-343	.34	8,6	.53	13,5	.26	6,5
.500	12,7	2820	2821	B 500-375	.38	9,5	.56	14,3		
NEW! .512	13,0	2822	2823	B 512-375	.38	9,5	.56	14,3		
.531	13,5	2824	2825	B 531-406	.41	10,3	.59	15,1		
.593	15,1	2833	2834	B 593-468	.47	11,9	.66	16,7		
.625	15,9	2827	2828	B 625-500	.50	12,7	.70	17,9	NEW!	
.687	17,4	2832	2835	B 687-562	.57	14,4	.76	19,3		
.750	19,1	2836	2837	B 750-625	.63	15,9	.83	21,0		
.781	19,8	2844	2845	B 781-625	.63	15,9	.86	21,8		
.875	22,2	2850	2851	B 875-750	.75	19,0	.95	24,0		
1.000	25,4	2847	2848	B 1000-875	.88	22,3	1.06	27,0		
1.093	27,8	2838	2839	B 1093-969	.97	24,6	1.16	29,4		

Standard colors black and white. Consult Heyco for other colors.

- For use in panels .062" (1,6 mm) and thinner.
- Lower overall height protrudes less through thin mounting panels; thus Shorty Bushings occupy less “real estate” inside your application.
- Insulating feed-thru bushings for limited internal clearance (minimum .125" (3,2 mm) applications).
- Insulate and isolate electric or telecommunications cables as well as low RPM shafts and push-pull rods.
- Locking fingers hold securely after only fingertip pressure snap-in installation.
- Locking fingers in fractional increments up to the maximum panel thickness.
- Available in multiple sizes for use in mounting holes from .187" (4,7 mm) to 1.093" (27,8 mm).

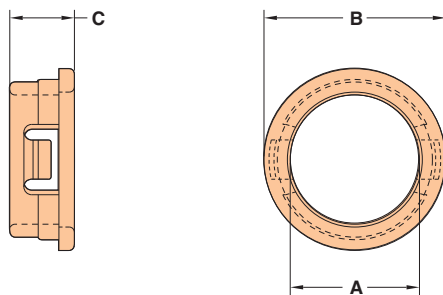

SINGLE PANEL DESIGN
(PANEL MAY BE THINNER)

Material: Nylon 6/6
 Certifications: Recognized under the Component Program of Underwriters' Laboratories, File E15331
 Flammability Rating: 94V-2
 Temperature Range: -4°F (-18°C) to 221°F (105°C)
 Also Certified by Canadian Standards Association, File 8919

Quick
Specs



Heyco® Metric Snap Bushings

Multiple Locking Steps for Panel Thickness up to 2,5 mm (.098")
Mounting Hole Diameter Range: 16,0 mm (.630") to 34,2 mm (1.347")

- Same design as Heyco Snap Bushings but **designed for metric sized mounting holes**.
- Convert raw-edged holes to smooth, neat insulated holes.
- Locking fingers snap into holes with fingertip pressure.
- Withstand a push back force of 35 pounds.
- Lock firmly into panel up to 2,5 mm (.098") thick.
- Multiple sizes for use in 16,0 mm (.630") to 32,0 mm (1.260") diameter holes. For other metric sizes, consult Heyco.
- For our complete range of Snap Bushings, see pages 6-3 thru 6-8.

MOUNTING HOLE DIAMETER		PART NO.	DESCRIPTION	PART DIMENSIONS						
mm.	in.			Black	A Inside Diameter		B Head Diameter		C Overall Height	
				mm.	in.	mm.	in.	mm.	in.	
NEW!	13,0	.512	2150	MSB 13-10	10,0	.39	13,7	.54	10,3	.41
	16,0	.630	2142	MSB 16-12	12,0	.47	18,5	.73		
	20,0	.787	2144	MSB 20-16	16,0	.63	22,6	.89		
NEW!	22,0	.866	2168	MSB 22-18	18,2	.71	24,1	.95	11,5	.45
	25,0	.984	2146	MSB 25-19	19,0	.75	27,8	1.09		
NEW!	28,0	1.102	2188	MSB 28-24	24,0	.95	31,3	1.24		
	32,0	1.260	2148	MSB 32-26	26,0	1.02	34,9	1.38		
NEW!	34,2	1.347	2190	MSB 34-26	26,2	1.03	36,8	1.45		

Standard color black. Consult Heyco for white and other colors.

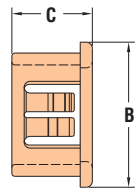

Metric Snap Bushing

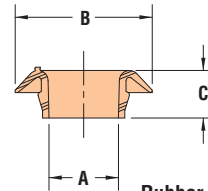
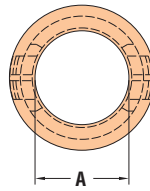

Rubber Grommets

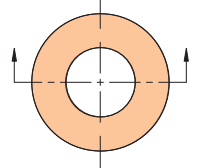

Heyco® UL Listed Thermoplastic Rubber Grommets

For Panel Thickness from .03" (0,8 mm) to .08" (2,0 mm)
Mounting Hole Diameter Range: .500" (12,7 mm) to 1.250" (31,8 mm)

- Convert raw-edged holes to smooth, neat, insulated holes.
- Retaining bead snaps securely into place.
- Insulate and mechanically protect cable, tubing, hose, rope, rods, and shafts.
- UL approved for applications up to 122° F (50°C).
- Six diameters fit panel thickness from .03" (0,8 mm) to .08" (2,0 mm).
- For Heyco UL Recognized Thermoplastic Rubber Grommets, see page 6-5.

MOUNTING HOLE DIAMETER		PART NO.	DESCRIPTION	PART DIMENSIONS					
in.	mm.			Black	A Inside Diameter		B Head Diameter		C Overall Height
				in.	mm.	in.	mm.	in.	mm.
.500	12,7	G1505	TG 500	.41	10,4	.81	20,6	.28	7,1
.625	15,9	G1506	TG 625	.52	13,2	.93	23,6	.31	7,9
.750	19,1	G1507	TG 750	.65	16,5	1.06	26,9	.35	8,9
.875	22,2	G1508	TG 875	.77	19,6	1.19	30,2		
1.000	25,4	G1509	TG 1000	.89	22,6	1.32	33,5		
1.250	31,8	G1510	TG 1250	1.12	28,4	1.60	40,6		

Molded from Thermoplastic Rubber.

Material	MSB	6/6 Nylon
Certifications		Recognized under the Component Program of Underwriters' Laboratories File E15331 Certified by the Canadian Standards Association File 8919
Flammability Rating		94V-2
Temperature Range		-4°F (-18°C) to 221°F (105°C)
Material	TG	Flex Temp (Thermoplastic Rubber)
Certifications		Listed under Underwriters' Laboratories File E15331
Temperature Range		32°F (0°C) to 122°F (50°C)

Quick Specs

Heyco® Snub Bushings

Multiple Locking Steps for Panel Thickness up to .125" (3,2 mm)
Mounting Hole Diameter Range: .375" (9,5 mm) to .875" (22,2 mm)

MOUNTING HOLE DIAMETER		APPROXIMATE CABLE DIAMETER* ACCOMMODATED		PART NO. Black	DESCRIPTION	PART DIMENSIONS			
in.	mm.	in.	mm.			A Head Diameter		B Overall Height	
.375	9,5	1/8	3,2	2034	K 375-125	.46	11,7	.42	10,7
.437	11,1	3/16	4,8	2047	K 437-187	.47	11,9	.44	11,2
.500	12,7	1/4	6,4	2057	K 500-250	.56	14,2		
.625	15,9	3/8	9,5	2068	K 625-375	.73	18,5		
.750	19,1	1/2	12,7	2088	K 750-500	.91	23,0		
.875	22,2	5/8	15,9	2109	K 875-625	1.02	25,8	.48	12,3

Standard color black. Consult Heyco for white and other colors.

*Consult Heyco for other Mounting Hole and Inside Diameter configurations. Our Axcell Rapid Response Team is ready to meet your requirements.

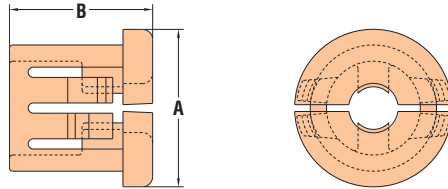

Heyco® Sealing Washers

WILL FIT THESE ELECTRICAL FITTING NPT TRADE SIZES	PART NO. Black	DESCRIPTION	PART DIMENSIONS					
			A Inside Diameter		B Outside Diameter		C Thickness	
			in.	mm.	in.	mm.	in.	mm.
1/4	3258	SW 1/4	.54	13,7	.80	20,2	.13	3,2
3/8	3259	SW 3/8	.67	17,0	1.01	25,5		
1/2	3260	SW 1/2	.85	21,6	1.24	31,5		
3/4	3261	SW 3/4	1.03	26,2	1.50	38,1	.14	3,4
1	3262	SW 1	1.28	32,5	1.77	45,0	.18	4,4
1-1/4	3264	SW 1-1/4	1.66	42,2	2.16	54,8	.16	4,1
1-1/2	3265	SW 1-1/2	1.86	47,2	2.44	62,0		
2	3257	SW 2	2.32	58,9	2.93	74,4	.18	4,6

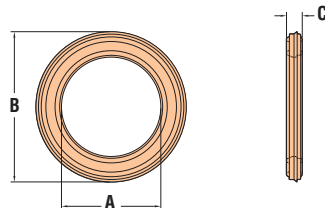

	Snub Bushing	Sealing Washers
Material	Nylon 6/6	Thermoplastic Elastomer
Certifications	Recognized under the Component Program of Underwriters' Laboratories, File E15331 (Snub Bushings only) Certified by Canadian Standards Association, File 8919 (Snub Bushings only)	
Flammability Rating	94V-2	94-V0
Temperature Range	-4°F (-18°C) to 221°F (105°C)	



- The ID opens to accept the cable then closes firmly when installed into the mounting hole.
- Provide insulation plus light strain relief.
- Suitable for 1/8" (3,2 mm) to 5/8" (15,9 mm) diameter cable, tubing or hose.



- Make fittings and connectors liquid tight, dust tight, and oil tight at enclosure.
- Suitable for wet locations requiring a separate gasket between the box and fitting.
- Also suitable for other panel sealing applications.
- Easy to install since washers seal off on the perimeter, not on the connector threads.
- Special double sealing ridges compensate for minor unevenness at enclosure.
- Quick Specs below do not apply.

Quick Specs

“Stay Connected” with



Bushings, Grommets, HEYcaps & Plugs

a PennEngineering® Company



- Flexible shutters adjust to accommodate and support any shape from .125" (3,2 mm) to a maximum inside diameter of 2.470" (62,7 mm).
- Absorb vibration and cushion and insulate cables, tubing, hoses or shafts.
- Locking fingers in fractional increments up to the maximum panel thickness.
- Fingertip pressure snap-locks the bushing into its mounting hole.

Heyco® Universal Bushings

Mounting Hole Diameter Range: .500" (12,7 mm) to 3.000" (76,2 mm)

MOUNTING HOLE DIAMETER		PART NO.		DESCRIPTION	PART DIMENSIONS					
in.	mm.	Black	White		Maximum Inside Diameter		A Head Diameter		B Overall Height	
					in.	mm.	in.	mm.	in.	mm.
Multiple Locking Steps for Panel Thickness up to .125" (3,2 mm)										
.500	12,7	2055	2056	UB 500	.31	7,6	.60	15,2	.39	9,8
.625	15,9	2077	2076	UB 625	.44	11,1	.73	18,5	.41	10,3
.750	19,1	2089	2085	UB 750	.50	12,7	.84	21,4		
.812	20,6	2106	2107	UB 812	.50	12,7	.89	22,6	.39	9,9
.875	22,2	2119	2129	UB 875	.56	14,3	.94	23,8	.45	11,5
		2118	-	UB 875-112*						
1.000	25,4	2137	2138	UB 1000	.75	19,1	1.06	27,0	.44	11,2
1.093	27,8	2157	2162	UB 1093	.81	20,6	1.16	29,5		
1.187	30,2	2153	2154	UB 1187	.95	24,1	1.25	31,8		
1.250	31,8	2155	2156	UB 1250	1.02	25,8	1.31	33,4	.45	11,5
1.375	34,9	2184	2185	UB 1375	1.00	25,4	1.49	37,8		
		2187	-	UB 1375-1750	1.00	25,4	1.75	44,5		
1.500	38,1	2213	2214	UB 1500	1.06	26,9	1.61	40,9		
1.750	44,5	2298	2299	UB 1750	1.38	34,9	1.87	47,5	.47	11,8
2.000	50,8	2422	2423	UB 2000	1.64	41,6	2.13	54,0	.49	12,4
Multiple Locking Steps for Panel Thickness up to .250" (6,4 mm)										
2.500	63,5	2440	2441	UB 2.500	1.97	50,0	2.63	66,8	.75	19,05
3.000	76,2	2460	2463	UB 3.000	2.47	62,7	3.15	80,0		

Standard colors black and white. Consult Heyco for other colors.

*UB 875-112 inside diameter adjusts for 1/8" to 5/8" cables; UB 875 adjusts for 3/16" to 9/16" cables.

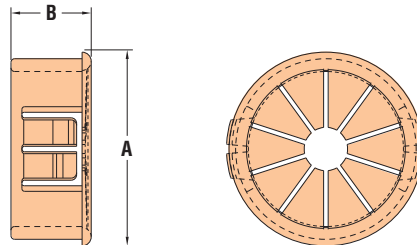

Quick Specs

Material	Nylon 6/6
Certifications	Recognized under the Component Program of Underwriters' Laboratories, File E15331 Certified by Canadian Standards Association, File 8919
Flammability Rating	94V-2
Temperature Range	-4°F (-18°C) to 221°F (105°C)

“Stay Connected” with



Bushings, Grommets, HEYcaps & Plugs

a PennEngineering® Company



Heyco® Shorty Universal Bushings

Single Locking Step for Panel Thickness up to .062" (1,6 mm)
Mounting Hole Diameter Range: .500" (12,7 mm) to 1.093" (27,8 mm)

MOUNTING HOLE DIAMETER		PART NO.	DESCRIPTION	PART DIMENSIONS					
in.	mm.			Black	Maximum Inside Diameter		A Head Diameter		B Overall Height
				in.	mm.	in.	mm.	in.	mm.
.500	12,7	2858	SUB 500	.31	7,6	.60	15,2	.25	6,4
.625	15,9	2861	SUB 625	.44	11,1	.73	18,5		
.750	19,1	2862	SUB 750	.50	12,7	.86	21,8		
.875	22,2	2863	SUB 875	.56	14,3	.94	23,8		
1.000	25,4	2864	SUB 1000	.75	19,0	1.06	27,0		
1.093	27,8	2158	SUB 1093	.81	20,6	1.16	29,4		

Standard color black. Consult Heyco for white and other colors.

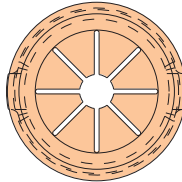
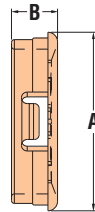

- For use in mounting panels **.062" (1,6 mm) and thinner.**
- Absorb vibration and cushion and insulate cables, tubing, hoses or shafts with limited internal clearance.
- Flexible shutters adjust to accommodate and support any shape from .125" (3,2 mm) to a maximum inside diameter of .812" (20,6 mm).
- Fingertip pressure snap-locks the bushing into its mounting hole.
- **See Quick Specs on 6-11.**

Heyco® Thick Panel Universal Bushings

Multiple Locking Steps for Panel Thickness up to .250" (6,4 mm)
Mounting Hole Diameter Range: .500" (12,7 mm) to 1.500" (38,1 mm)

MOUNTING HOLE DIAMETER		PART NO.	DESCRIPTION	PART DIMENSIONS					
in.	mm.			Black	Maximum Inside Diameter		A Head Diameter		B Overall Height
				in.	mm.	in.	mm.	in.	mm.
.500	12,7	3001	UBT 500	.31	7,6	.60	15,2	.55	13,8
.625	15,9	3118	UBT 625*	.44	11,1	.73	18,5	.51	13,0
.750	19,1	3119	UBT 750*	.50	12,7	.84	21,4	.55	13,8
.875	22,2	3120	UBT 875	.56	14,3	.94	23,8		
1.000	25,4	3121	UBT 1000	.75	19,1	1.06	27,0		
1.093	27,8	3002	UBT 1093	.81	20,6	1.16	29,5		
1.375	34,9	3003	UBT 1375	1.00	25,4	1.49	37,8	.56	14,2
1.500	38,1	3122	UBT 1500	1.06	26,9	1.61	40,9		

Standard color black. Consult Heyco for white and other colors.
*Single Locking Step for Panel Thickness up to .250" (6,4 mm).

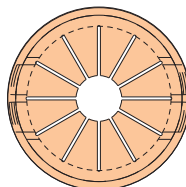
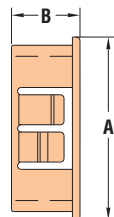

- For use in mounting panels up to **.250" thick.**
- Flexible shutters to absorb vibration on the inside diameter.
- Insulate and mechanically protect electrical and telecommunications cables, tubing, hose, rope, and utility lines.
- Withstand a push back force of 35 pounds.
- Locking fingers snap into holes with fingertip pressure.
- Locking fingers in fractional increments up to the maximum panel thickness.
- Available in multiple sizes for use in .500" (12,7 mm) to 1.500" (38,1 mm) diameter holes.
- **See Quick Specs on 6-11.**



- **Split design allows side entry** and encirclement of preassembled harnesses, power cords, capillary tubes or other assemblies that have segments larger than the bushing's ID.
- Parts can be assembled into holes that already contain cables or tubing.
- Only fingertip pressure required to snap-lock the bushing into its mounting hole.
- Locking fingers in fractional increments up to the maximum panel thickness.
- Flexible shutters adjust to accommodate and support any shape from .125" (3,2 mm) to a maximum inside diameter of 1.970" (43,2 mm).
- Absorb vibration, cushion and insulate cables, tubing, hoses or shafts.
- Available in multiple sizes for use in .500" (12,7 mm) to 2.500" (63,5 mm) diameter holes.

Heyco® Open/Closed Universal Bushings

Mounting Hole Diameter Range: .500" (12,7 mm) to 2.500" (63,5 mm)

MOUNTING HOLE DIAMETER		PART NO. Black	DESCRIPTION	Maximum Inside Diameter		PART DIMENSIONS A Head Diameter		B Overall Height	
in.	mm.			in.	mm.	in.	mm.	in.	mm.
Multiple Locking Steps for Panel Thickness up to .125" (3,2 mm)									
.500	12,7	2055SP	OCUB 500	.31	7,6	.56	14,2	.39	9,8
.625	15,9	2077SP	OCUB 625	.44	11,1	.69	17,5		
.750	19,1	2089SP	OCUB 750	.50	12,7	.50	20,3		
.875	22,2	2119SP	OCUB 875	.56	14,3	.92	23,4		
1.000	25,4	2137SP	OCUB 1000	.75	19,1	1.05	26,7	.41	10,3
1.093	27,8	2157SP	OCUB 1093	.81	20,6	1.16	29,5		
1.250	31,8	2196SP	OCUB 1250	.94	23,8	1.44	36,6		
1.375	34,9	2184SP	OCUB 1375	1.00	25,4	1.44	36,6		
1.500	38,1	2213SP	OCUB 1500	1.06	26,9	1.56	39,6	.42	10,7
2.000	50,8	2422SP	OCUB 2000	1.64	41,7	2.12	53,9		

Multiple Locking Steps for Panel Thickness up to .250" (6,4 mm)

2.500	63,5	2440SP	OCUB 2.5	1.97	43,2	2.60	66,0	.72	18,3
-------	------	---------------	----------	------	------	------	------	-----	------

Standard color black. Consult Heyco for white and other colors.

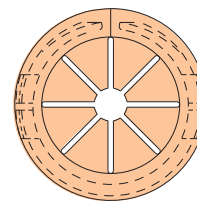
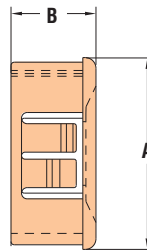

Quick
Specs

Material
Certifications

Nylon 6/6

Recognized under the Component Program of Underwriters' Laboratories, File E15331

Certified by the Canadian Standards Association, File 8919

Flammability Rating
Temperature Range

94V-2

-4°F (-18°C) to 221°F (105°C)

“Stay Connected” with



Bushings, Grommets, HEYcaps & Plugs

a PennEngineering® Company



Heyco® Open/Closed Bushings

Mounting Hole Diameter Range: .375" (9,5 mm) to 2.500" (63,5 mm)

Small Packs Available

MOUNTING HOLE DIAMETER		PART NO.	DESCRIPTION	PACKAGING		PART DIMENSIONS					
in.	mm.			BULK (Std)	SMALL PACK* NEW	A Inside Diameter		B Head Diameter		C Overall Height	
Multiple Locking Steps for Panel Thickness up to .125" (3,2 mm)											
.375	9,5	2865	OCB 375	20000	100	.27	6,7	.42	10,7	.39	9,9
.437	11,1	2867	OCB 437	15000	100	.33	8,4	.50	12,7		
.500	12,7	2871	OCB 500	20000	100	.31	7,9	.56	14,3		
NEW! .512	13,0	2875	OCB 512	20000	100	.35	9,0	.59	14,9		
.562	14,3	2869	OCB 562	15000	100	.39	9,9	.64	16,3		
.625	15,9	2872	OCB 625	8500	100	.45	11,1	.69	17,5		
NEW! .650	16,5	2914	OCB 650	8500	100	.48	12,3	.73	18,6		
.750	19,1	2873	OCB 750	10000	100	.55	12,7	.78	19,8	.41	10,3
NEW! .866	22,0	2917	OCB 866	7500	100	.68	17,3	.98	24,8		
.875	22,2	2874	OCB 875	7500	100	.67	17,0	.92	23,4		
NEW! .984	25,0	2920	OCB 984	4000	100	.80	20,4	1.04	26,4		
1.000	25,4	2878	OCB 1000	4000	50	.81	19,1	1.05	26,6		
1.093	27,8	2879	OCB 1093	4000	50	.88	20,6	1.16	29,4		
1.250	31,8	2881	OCB 1250	5000	50	1.05	25,8	1.34	34,1		
1.375	34,9	2882	OCB 1375	2500	50	1.17	25,4	1.47	37,3		
1.500	38,1	2883	OCB 1500	2500	25	1.25	26,9	1.58	40,1	.42	10,7
2.000	50,8	2900	OCB 2000	2000	25	1.73	43,9	2.12	53,9		
Multiple Locking Steps for Panel Thickness up to .250" (6,4 mm)											
2.500	63,5	2909	OCB 2.5	500	10	2.00	50,8	2.60	66,0	.72	18,3

Standard color black. Consult Heyco for white and other colors.

*To order Small Packs, please add the suffix -P to Part No., e.g., 2865-P

Heyco® Open/Closed Shorty Bushings

Single Locking Step for Panel Thickness up to .062" (1,6 mm)

Mounting Hole Diameter Range: 7,0 mm (.276") 27,0 mm (1.063")

MOUNTING HOLE DIAMETER		PART NO.	DESCRIPTION	PART DIMENSIONS					
in.	mm.			A Inside Diameter	B Head Diameter		C Overall Height		
.276	7,0	2934	SOCB 07M	.22	5,6	.35	8,9	.24	6,0
.512	13,0	2938	SOCB 13M	.38	9,7	.56	14,2		
.630	16,0	2941	SOCB 16M	.52	13,2	.71	18,0		
.748	19,0	2943	SOCB 19M	.63	16,0	.83	21,1	.25	6,4
.866	22,0	2945	SOCB 22M	.75	19,1	.98	24,9		
.945	24,0	2947	SOCB 24M	.82	20,8	1.06	26,9		
1.063	27,0	2950	SOCB 27M	.95	24,8	1.13	28,7	.26	6,5

Standard color black. Consult Heyco for white and other colors.

Material	Nylon 6/6
Certifications	Recognized under the Component Program of Underwriters' Laboratories File E15331 Certified by the Canadian Standards Association File 8919
Flammability Rating	94V-2
Temperature Range	-4°F (-18°C) to 221°F (105°C)

- Split design allows side entry and encirclement of preassembled harnesses, capillary tubes, computer cables, power cords, or other assemblies that have segments larger than the bushing's I.D.

- May also be assembled into holes that already contain cable, wire or other filaments.

- Fingertip pressure snap-locks the bushing into its mounting hole.

- Locking fingers in fractional increments up to the maximum panel thickness.

- Multiple sizes for use in mounting holes from .375" (9,5 mm) to 2.500" (63,5 mm).

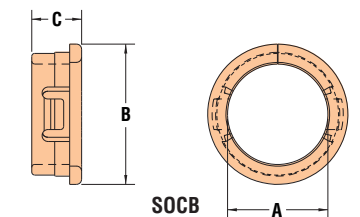
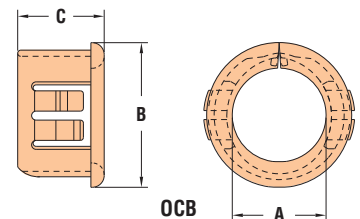

- For use in panels .062" (1,6 mm) and thinner.

- Lower overall height protrudes less through thin mounting panels; thus Shorty Open/Closed Bushings occupy less "real estate" inside your application.

- Split design allows side entry and encirclement of preassembled harnesses, power cords, capillary tubes or other assemblies that have segments larger than the bushing's ID.

- May also be assembled into holes that already contain cable, wire or other filaments.

- Fingertip pressure snap-locks the bushing into its mounting hole.



- Use with Flexible Armored Cable (BX) and Flexible Metallic Conduit (FMC), to insulate rough cut conduit ends.
- Chamfered lead-in allows for fast installation.
- Suitable for installation at temperatures up to 194°F (90°C) and as low as -40°F (-40°C).
- Size-marked for easy identification.

Heyco® Armor Bushings

WILL FIT THESE ARMORED CABLES (AWG/CONDUCTORS)	PART NO. Red	DESCRIPTION	PART DIMENSIONS					
			A Inside Diameter		B Head Diameter		C Overall Height	
			in.	mm.	in.	mm.	in.	mm.
14/2, 14/3, 12/2, 12/3	2264	AB 0	.37	9,4	.68	17,3	.58	14,7
14/4, 6/1, 4/1	2265	AB 1	.44	11,2	.70	17,8	.63	16,0
12/4, 10/2, 10/3, 2/1	2266	AB 2	.57	14,0	.85	21,6	.61	15,5
	2281	AB Orange*	.58	14,7	.90	22,9	.50	12,7
10/4, 8/2, 8/3, 1/1	2267	AB 3	.73	18,5	1.02	25,9	.70	17,8

Standard color red except as noted.
*This part is not UL or CSA certified.

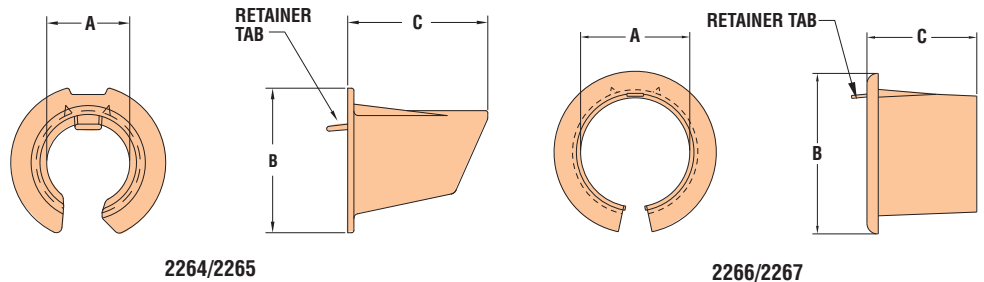

- Converts raw-edged pipe ends with NPT threads to smooth insulated ends.
- Insulates and mechanically protects lamp cords, other electrical and communications cables, tubing, hose, rope, and utility lines.
- Molded of type Nylon 6/6.
- Quick Specs below do not apply.

Heyco® Threaded Insulating Bushing

TRADE SIZE NPT	PART NO.	DESCRIPTION	PART DIMENSIONS					
			A Inside Diameter		B Head Diameter		C Overall Height	
			in.	mm.	in.	mm.	in.	mm.
1/8	2282	IB 1/8 NPT BLACK	.27	6,8	.53	13,4	.30	7,6

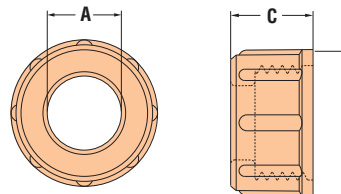

Quick
Specs

Material
Certifications
Temperature Range

High Dielectric Polyethylene
 Listed under Underwriters' Laboratories' File E51579
 Certified by the Canadian Standards Association File 213253
 -40°F (-40°C) to 194°F (90°C)

“Stay Connected” with



Bushings, Grommets, HEYcaps & Plugs

a PennEngineering® Company



Heyco® Threaded Smooth Bore Bushings

WILL FIT THESE INTERNALLY THREADED NPT PIPE ENDS OR PORTS	PART NO.		DESCRIPTION	PART DIMENSIONS					
	Black	Gray		A Inside Diameter		B Wrenching Flats		C Overall Height	
				in.	mm.	in.	mm.	in.	mm.
1/4	3621B	3621	TSB 1/4	.31	7,9	.63	16,0	.66	16,8
3/8	3622B	3622	TSB 3/8	.43	10,9	.83	21,0	.69	17,5
1/2	3623B	3623	TSB 1/2	.58	14,7	.98	24,9	.81	20,6
3/4	3624B	3624	TSB 3/4	.74	18,8	1.30	33,0	.86	21,8

Standard colors black and gray.

- Convert raw-edged threaded holes to smooth insulated through holes.
- Used to protect threaded holes. Eliminate sharp edges so wires are protected.
- Insulate and mechanically protect electrical and communication cables, tubing, rope, and utility lines.
- Molded from electrically non-conductive Nylon 6/6.

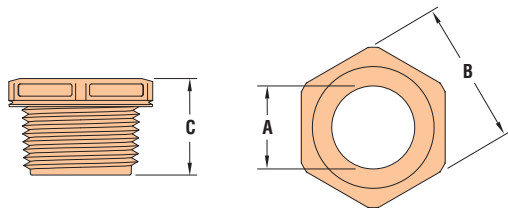

Threaded Smooth Bore Bushing

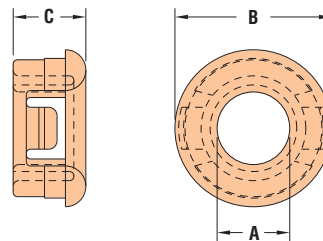

Snap-In Smooth Bore Bushing

Heyco® Snap-In Smooth Bore Bushings

Mounting Hole Diameter Range: .500" (12,7 mm) to 1.093" (27,8 mm)

MOUNTING HOLE DIAMETER	PART NO.		DESCRIPTION	PART DIMENSIONS					
	Black			A Inside Diameter*		B Head Diameter		C Overall Height	
in.	mm.			in.	mm.	in.	mm.	in.	mm.
Single Locking Step for Panel Thickness up to .062" (1,6 mm)									
.500	12,7	2514	S 50	.25	6,4	.56	14,2	.27	6,9
.875	22,3	2540	S 87	.52	13,2	.98	24,9	.32	8,1
Multiple Locking Steps for Panel Thickness up to .125" (3,2 mm)									
.625	15,9	2516	S 625-4	.25	6,4	.72	18,3		
.750	19,1	2535	S 750-5	.36	9,1	.91	23,1	.44	11,2
.875	22,3	2552	S 875-9	.56	14,2	.97	24,6		
1.000	25,4	2554	S 1000-9	.60	15,2	1.19	30,2	.52	13,1
1.093	27,8	2555	S 1093-10	.63	16,0	1.21	30,7		

Standard color black. Consult Heyco for white and other colors.

*Consult Heyco for other Mounting Hole and Inside Diameter configurations. Our Axcell Rapid Response Team is ready to meet your requirements.



- Extra internal insulating sleeve creates a smooth bore and prevents locking fingers from protruding into the ID of the Bushing.
- Large radius exit hole.
- Used to protect through-holes. Eliminate sharp edges so wires are protected.
- Absorb vibration, and cushion and insulate wires.
- Can be used as bushing for rotating shafts.
- Bushing inserts into mounting hole with fingertip pressure.

Material	Nylon 6/6
Certifications (Snap-In only)	Recognized under the Component Program of Underwriters' Laboratories File E15331 Certified by the Canadian Standards Association File 8919
Flammability Rating	94V-2
Temperature Range	-4°F (-18°C) to 221°F (105°C)

Quick Specs

“Stay Connected” with



Bushings, Grommets, HEYcaps & Plugs

a PennEngineering® Company

Consult Heyco
for Colors Other
Than Black



HEYCo-molded™ Liquid Tight Break-Thru Plugs

Mounting Hole Diameter Range: .500" (12,7 mm) to 1.500" (38,1 mm)

Small Packs Available

PANEL DIMENSIONS				CABLE DIAMETER RANGE		PART NO. Black	PACKAGING		DESCRIPTION	PART DIMENSIONS			
Thickness at Locking Finger Steps		Mounting Hole Diameter*		in.	mm.		BULK (Std)	SMALL PACK**		A Head Diameter		B Overall Height	
in.	mm.	in.	mm.	in.	mm.			in.	mm.	in.	mm.		
With Five Locking Finger Steps for Panels up to .063" (1,6 mm) Thick													
.020	0,5	.500	12,7	.080 - .200	2,0 - 5,1	C2008	1000	10	LTBP 500-063	.92	23,4		
.032	0,8	.625	15,9	.130 - .375	3,3 - 9,5	C2012	1000	10	LTBP 625-063	1.03	26,2		
.040	1,0	.750	19,1	.175 - .400	4,4 - 10,2	C2016	1000	10	LTBP 750-063	1.15	29,2	.32	8,1
.048	1,2	.875	22,2	.130 - .450	3,3 - 11,4	C2020	1000	10	LTBP 875-063	1.28	32,5		
.063	1,6	1.000	25,4	.200 - .715	5,1 - 18,2	C2022	1000	10	LTBP 1000-063	1.43	36,3		
		1.093	27,8	.250 - .765	6,4 - 19,4	C2024	1000	10	LTBP 1093-063	1.53	38,9		

With Seven Locking Finger Steps for Panels from .063" (1,6 mm) to .250" (6,4 mm) Thick													
in.	mm.	in.	mm.	in.	mm.	Part No.	Bulk (Std)	Small Pack**	Description	A Head Diameter (in.)	A Head Diameter (mm.)	B Overall Height (in.)	B Overall Height (mm.)
.063	1,6	.500	12,7	.080 - .200	2,0 - 5,1	C2058	1000	10	LTBP 500-250	.92	23,4		
.080	2,0	.625	15,9	.130 - .375	3,3 - 9,5	C2062	1000	10	LTBP 625-250	1.03	26,2		
.094	2,4	.750	19,1	.175 - .400	4,4 - 10,2	C2066	1000	10	LTBP 750-250	1.15	29,2	.63	15,9
.125	3,2	.875	22,2	.130 - .450	3,3 - 11,4	C2070	1000	10	LTBP 875-250	1.28	32,5		
.157	4,0	1.000	25,4	.200 - .715	5,1 - 18,2	C2072	1000	10	LTBP 1000-250	1.43	36,3		
.200	5,1	1.093	27,8	.250 - .765	6,4 - 19,4	C2074	1000	10	LTBP 1093-250	1.53	38,9		
.250	6,4	1.375	34,9	.300 - .950	7,6 - 24,1	C2080	1000	10	LTBP 1375-250	1.80	45,7	.67	17,0
		1.500	38,1	.375 - 1.060	9,5 - 26,9	C2082	1000	10	LTBP 1500-250	1.93	49,0		

Standard color black. Consult Heyco for other colors.

*Consult Heyco for other Mounting Hole Diameters. Our Axcell Rapid Response Team is ready to meet your requirements.

**To order Small Packs, please add the suffix -P to Part No., e.g., C2008-P

- These **co-molded** nylon and elastomer parts function as **Liquid Tight Plugs** with an IP 67/68 rating, yet can be pierced by **round wire, cable or tubing** to function as **Liquid Tight Bushings** with the same resulting IP 67/68 rating.
- **Certified by UL under UL 635**
- For use in panels as thin as .020" (0,5 mm) and as thick as .250" (6,4 mm).
- Provide liquid tight closure when used as a plug. When pierced, function as a liquid tight bushing that convert raw edged holes to smooth, neat, insulated holes.
- Used as a liquid tight bushing, HEYCo-molded Liquid Tight Break-Thru Plugs insulate and mechanically protect electrical and telecommunications cable, tubing, hose, rope, and utility lines.
- Locking fingers snap into holes with fingertip pressure.
- Locking fingers in fractional increments up to the maximum panel thickness.
- Withstand a push back force of greater than 35 pounds.
- Available in multiple sizes for use in .500" (12,7 mm) to 1.500" (38,1 mm) diameter holes.

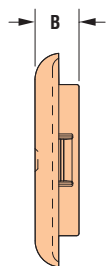
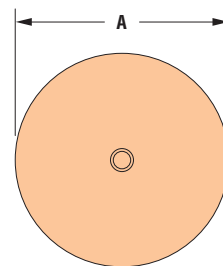

Materials	Nylon 6/6 and TPE
Certifications	Recognized under the Component Program of Underwriters' Laboratories File E15331
Flammability Rating	HB
Temperature Range	-40°F (-40°C) to 212°F (100°C)
IP Rating	IP 67/68

“Stay Connected” with



Bushings, Grommets, HEYcaps & Plugs

a PennEngineering® Company



Heyco® EPDM Snap-In Liquid Tight Bushings

Mounting Hole Diameter Range: .492" (12,5 mm) to 1.988" (50,2 mm)

MOUNTING HOLE DIAMETER		CABLE DIAMETER RANGE		PART NO.		DESCRIPTION	Hole Size	PART DIMENSIONS					
				Black	Gray			D Head Diameter	L Overall Length	H Head Thickness			
in.	mm.	in.	mm.				in.	mm.	in.	mm.	in.	mm.	
PG Sizes for Panel Thickness from .04" (1,0 mm) to .16" (4,0 mm)													
.519	13,2	.12-.20	3,0-5,0	4014B	4014	LTB 30-50/PG7	PG7	.77	19,5	.53	13,5		
.630	16,0	.20-.28	5,0-7,0	4015B	4015	LTB 50-70/PG9	PG9	.81	20,5	.77	19,5	.28	7,0
.750	19,0	.28-.39	7,0-10,0	4016B	4016	LTB 70-100/PG11	PG11	.98	25,0	.83	21,0		
.906	23,0	.31-.55	8,0-14,0	4017B	4017	LTB 80-140/PG16	PG16	1.10	28,0	.89	22,5	.26	6,5
1.142	29,0	.55-.79	14,0-20,0	4018B	4018	LTB 140-200/PG21	PG21	1.37	34,7	1.04	26,5	.30	7,5
1.500	38,0	.79-1.02	20,0-26,0	4019B	4019	LTB 200-260/PG29	PG29	1.80	45,7	1.10	28,0	.28	7,0
1.890	48,0	1.02-1.38	26,0-35,0	4020B	4020	LTB 260-350/PG36	PG36	2.26	57,5	1.44	36,5	.30	7,7
Metric Sizes for Panel Thickness from 1,3 mm (.05") to 5,1 mm (.20")													
.492	12,5	.16-.28	4,0-7,0	4007B	4007	LTB 30-50/M12*	M12	.79	20,0	.50	12,7		
.650	16,5	.20-.35	5,0-9,0	4008B	4008	LTB 50-70/M16	M16	.83	21,0	.71	18,0		
.807	20,5	.32-.51	8,0-13,0	4009B	4009	LTB 70-100/M20	M20	1.00	25,5	.79	19,5	.26	6,5
1.004	25,4	.43-.67	11,0-17,0	4010B	4010	LTB 100-140/M25	M25	1.20	30,5	.85	21,5		
1.280	32,5	.59-.79	15,0-20,0	4011B	4011	LTB 140-200/M32	M32	1.52	38,5	.98	24,8		
1.594	40,5	.75-1.10	19,0-28,0	4012B	4012	LTB 200-260/M40	M40	1.91	48,5	1.18	30,0	.32	8,1
1.988	50,2	1.06-1.38	27,0-35,0	4013B	4013	LTB 260-350/M50	M50	2.38	60,5	1.38	35,0		

*Panel thickness from 0,5 mm (.02") to 2,0 mm (.08").

- **Simple to install**—snap LTB into place, cut cable end at a 45° angle, pierce thin LTB membrane then insert and pull back cable to form a liquid tight seal.
- Available in Black and Gray color.
- Provide light strain relief to the cable.
- Can be used as a liquid tight plug. Offers protection to IP 67.
- Ozone and weather resistant.
- For outdoor and indoor applications.
- Sizes available to fit cable diameters ranging from .12" (3,0 mm) up to 1.38" (35,0 mm).



1. A sharpened dowel pin is selected—slightly smaller than the wire diameter

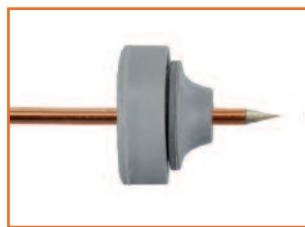

2. The dowel pin is inserted into the opening on the front of the LTB and pushed through the membrane

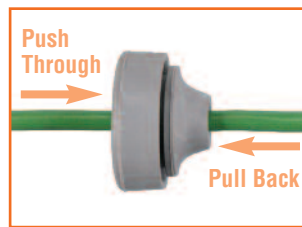

3. Wire is inserted through the LTB and then pulled back to create a seal

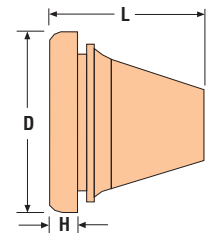

Material	EPDM
Temperature Range	-40°F (-40°C) to 200°F (93°C)
IP Rating	IP 67

Quick Specs



Heyco® Rubber Grommets

For Panels .063" (1,6 mm) Thick

- **Used to protect through holes.** Help eliminate sharp edges so your wires are protected and add aesthetic value to your application.
- 115 sizes available that will accommodate mounting holes ranging from .250" (6,4 mm) to holes as large as 2.375" (60,3 mm) diameter and panel thicknesses from .063" (1,6 mm) to .188" (4,8 mm).
- Rubber grommets are constructed of SBR (unless otherwise noted) with an operating temperature range of -40°F (-40°C) to 221°F (105°C).
- SBR grommets have good water resistant characteristics and are suitable for most moderate chemicals and wet or dry organic acids.
- Provide vibration dampening.

MOUNTING HOLE DIAMETER	PART NO.	DESCRIPTION	MATERIAL	PART DIMENSIONS					
				A Inside Diameter		B Head Diameter		C Overall Height	
in. mm.	Black			in. mm.	in. mm.	in. mm.	in. mm.	in. mm.	

For .063" (1,6 mm) Thick Panels

.250	6,4	G1004	RG 250-4-2	SBR	.13	3,2	.34	8,7	.19	4,8
		G1005	RG 250-5-2	SBR	.16	4,0	.38	9,5		
		G1006	RG 250-5-2A	SBR	.16	4,0	.44	11,1	.38	9,5
.312	7,9	G1017	RG 312-6-2	SBR	.19	4,8	.41	10,3	.22	5,6
		G1018	RG 312-6-2A	Nitrile	.19	4,8	.44	11,1	.19	4,8
		G1019	RG 312-6-2B	SBR	.19	4,8	.50	12,7	.25	6,4
		G1026	RG 312-7-2	SBR	.22	5,6	.44	11,1	.19	4,8
.375	9,5	G1037	RG 375-8-2	EPDM	.25	6,4	.56	14,3	.25	6,4
		G1042	RG 375-9-2	SBR	.28	7,1				
.437	11,1	G1052	RG 437-8-2	SBR	.25	6,4	.63	15,9	.19	4,8
		G1053	RG 437-8-2A	Isoprene	.25	6,4	.63	15,9	.31	8,0
		G1061	RG 437-10-2	SBR	.31	8,0	.63	15,9	.28	7,1
.500	12,7	G1089	RG 500-12-2	SBR	.38	9,5	.63	15,9	.25	6,4
		G1090	RG 500-12-2A	SBR	.38	9,5	.69	17,5	.28	7,1
.562	14,3	G1112	RG 562-10-2	SBR	.31	8,0	.81	20,7	.31	8,0
		G1123	RG 562-14-2	SBR	.44	11,1	.75	19,1	.25	6,4
.625	15,9	G1130	RG 625-12-2	SBR	.38	9,5	.88	22,2	.31	8,0
		G1137	RG 625-16-2	SBR	.50	12,7	.81	20,7	.28	7,1
.687	17,5	G1150	RG 687-14-2	SBR	.44	11,1	.94	23,8	.31	8,0
		G1151	RG 687-14-2A	SBR	.44	11,1	.94	23,8	.35	8,8
		G1155	RG 687-16-2	SBR	.50	12,7	.88	22,2	.25	6,4
.750	19,1	G1174	RG 750-12-2	SBR	.38	9,5	1.00	25,4	.38	9,5
		G1176	RG 750-16-2	SBR	.50	12,7	.88	22,2		
		G1177	RG 750-16-2A	SBR	.50	12,7	1.00	25,4	.25	6,4
.812	20,6	G1192	RG 812-16-2	SBR	.50	12,7				
		G1197	RG 812-18-2	SBR	.56	14,3	1.06	27,0	.31	8,0
.875	22,2	G1208	RG 875-10-2	SBR	.31	8,0	1.38	34,9	.25	6,4
		G1215	RG 875-20-2	SBR	.63	15,9	1.13	28,6	.31	8,0
1.000	25,4	G1242	RG 1000-12-2	SBR	.38	9,5	1.25	31,8	.25	6,4
		G1246	RG 1000-16-2	SBR	.50	12,7				
		G1252	RG 1000-22-2	SBR	.69	17,5	1.31	33,4	.38	9,5
1.062	27,0	G1258	RG 1000-24-2	SBR	.75	19,1	1.25	31,8	.30	7,5
		G1269	RG 1062-24-2	SBR	.75	19,1	1.38	34,9	.38	9,5
1.250	31,8	G1290	RG 1250-16-2	SBR	.50	12,7				
		G1294	RG 1250-20-2	SBR	.63	15,9	1.50	38,1	.25	6,4
		G1298	RG 1250-24-2	SBR	.75	19,1	1.63	41,3		
		G1303	RG 1250-28-2	SBR	.88	22,2	1.63	41,3	.44	11,1
1.375	34,9	G1311	RG 1250-32-2	SBR	1.00	25,4	1.56	39,7	.31	8,0
		G1320	RG 1375-32-2	SBR	1.00	25,4	1.75	44,5	.44	11,1
1.500	38,1	G1347	RG 1500-36-2	SBR	1.13	28,6	1.88	47,6	.38	9,5
		G1349	RG 1500-40-2	Nitrile	1.25	31,8	1.88	47,6	.34	8,7

Standard color black.

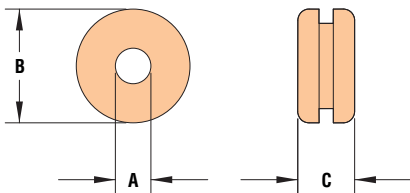

Quick Specs

Material
Temperature Range

SBR, Nitrile, EPDM, or Isoprene
-40°F (-40°C) to 221°F (105°C)

“Stay Connected” with



Bushings, Grommets, HEYcaps & Plugs

a PennEngineering® Company



Heyco® Rubber Grommets

For Panels from .063" (1,6 mm) to .125" (3,2 mm) Thick

MOUNTING HOLE DIAMETER		PART NO.	DESCRIPTION	MATERIAL	PART DIMENSIONS					
in.	mm.				A Inside Diameter		B Head Diameter		C Overall Height	
		Black			in.	mm.	in.	mm.	in.	mm.
For .063" (1,6 mm) Thick Panels (continued)										
1.750	44,5	G1369	RG 1750-48-2	SBR	1.50	38,1	2.13	54,0	.44	11,1
2.375	60,3	G1409	RG 2.375-40-2	Nitrile	1.25	31,8	2.75	69,9		
2.500	63,5	G1418 G1422	RG 2.5-40-2 RG 2.5-68-2	Nitrile SBR	1.25 2.13	31,8 54,0	2.88	73,0		
For .078" (2,0 mm) Thick Panels										
1.000	25,4	G1253	RG 1000-22-3	SBR	.69	17,5	1.31	33,4	.38	9,5
For .094" (2,4 mm) Thick Panels										
.281	7,1	G1010	RG 281-6-3	SBR	.19	4,8	.44	11,1	.22	5,6
.312	7,9	G1014	RG 312-6-3	SBR	.19	4,8	.50	12,7	.28	7,1
.375	9,5	G1033	RG 375-4-3	SBR	.13	3,2	.50	12,7	.31	8,0
		G1038	RG 375-8-3	SBR	.25	6,4	.50	12,7	.25	6,4
		G1039	RG 375-8-3A	SBR	.25	6,4	.56	14,3	.28	7,1
.437	11,1	G1062	RG 437-10-3	SBR	.31	8,0	.63	15,9	.31	8,0
.750	19,1	G1178	RG 750-16-3	SBR	.50	12,7	.88	22,2	.34	8,7
		G1179	RG 750-16-3A	SBR	.50	12,7	.97	24,6	.28	7,1
1.125	28,6	G1281	RG 1125-28-3	SBR	.88	22,2	1.50	38,1	.34	8,7
2.000	50,8	G1387	RG 2000-48-3	SBR	1.50	38,1	2.38	60,3	.38	9,5
For .110" (2,8 mm) Thick Panels										
.630	16,0	G1140	RG 630-16-3	SBR	.50	12,7	.81	20,6	.30	7,6
For .125" (3,2 mm) Thick Panels										
.312	7,9	G1020	RG 312-6-4	SBR	.19	4,8	.44	11,8	.25	6,4
.406	10,3	G1047	RG 406-9-4	SBR	.28	7,1	.63	15,9	.38	9,5
.437	11,1	G1056	RG 437-8-4	SBR	.25	6,4	.63	15,9	.25	6,4
.500	12,7	G1092	RG 500-12-4	SBR	.38	9,5	.63	15,9	.31	8,0
		G1093	RG 500-12-4A	SBR	.38	9,5	.63	15,9	.41	10,3
.562	14,3	G1114	RG 562-10-4	SBR	.31	8,0	.81	20,7	.38	9,5
.625	15,9	G1127	RG 625-6-4	Nitrile	.19	4,8	.88	22,2	.25	6,4
		G1132	RG 625-12-4	SBR	.38	9,5	.88	22,2	.38	9,5
.687	17,5	G1152	RG 687-14-4	SBR	.44	11,1	.94	23,8	.38	9,5
.812	20,6	G1188	RG 812-12-4	SBR	.38	9,5	1.06	27,0		
		G1193	RG 812-16-4	SBR	.50	12,7	1.06	27,0		
		G1198	RG 812-18-4	SBR	.56	14,3	1.06	27,0		
.875	22,2	G1218	RG 875-20-4	SBR	.63	15,9	1.13	28,6	.31	8,0
1.000	25,4	G1244	RG 1000-12-4	SBR	.38	9,5	1.25	31,8		
		G1247	RG 1000-16-4	SBR	.50	12,7	1.25	31,8		
		G1255	RG 1000-22-4	SBR	.69	17,5	1.31	33,4		
1.250	31,8	G1259	RG 1000-24-4	EPDM	.75	19,1	1.19	30,2	.44	11,1
		G1260	RG 1000-24-4A	SBR	.75	19,1	1.25	31,8	.38	9,5
1.250	31,8	G1291	RG 1250-16-4	SBR	.50	12,7	1.50	38,1	.31	8,0
		G1299	RG 1250-24-4	SBR	.75	19,1	1.63	41,3	.31	8,0
		G1304	RG 1250-28-4	SBR	.88	22,2	1.63	41,3	.50	12,7

Standard color black.

- **Used to protect through holes.** Help eliminate sharp edges so your wires are protected and add aesthetic value to your application.
- 115 sizes available that will accommodate mounting holes ranging from .250" (6,4 mm) to holes as large as 2.375" (60,3 mm) diameter and panel thicknesses from .063" (1,6 mm) to .188" (4,8 mm).
- Rubber grommets are constructed of SBR (unless otherwise noted) with an operating temperature range of -40°F (-40°C) to 221°F (105°C).
- SBR grommets have good water resistant characteristics and are suitable for most moderate chemicals and wet or dry organic acids.
- Provide vibration dampening.

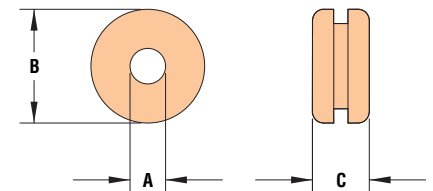

Material
Temperature Range

SBR, Nitrile or EPDM
-40°F (-40°C) to 221°F (105°C)

Quick
Specs



Heyco® Rubber Grommets

For Panels .125" (3,2 mm) to .188" (4,8 mm) Thick

- **Used to protect through holes.** Help eliminate sharp edges so your wires are protected and add aesthetic value to your application.
- 115 sizes available that will accommodate mounting holes ranging from .250" (6,4 mm) to holes as large as 2.375" (60,3 mm) diameter and panel thicknesses from .063" (1,6 mm) to .188" (4,8 mm).
- Rubber grommets are constructed of SBR (unless otherwise noted) with an operating temperature range of -40°F (-40°C) to 221°F (105°C).
- SBR grommets have good water resistant characteristics and are suitable for most moderate chemicals and wet or dry organic acids.
- Provide vibration dampening.

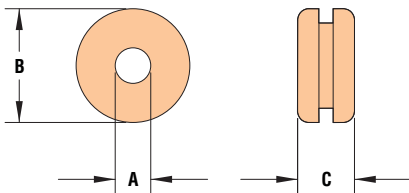

MOUNTING HOLE DIAMETER		PART NO. Black	DESCRIPTION	MATERIAL	PART DIMENSIONS					
in.	mm.				A Inside Diameter		B Head Diameter		C Overall Height	
					in.	mm.	in.	mm.	in.	mm.

For .125" (3,2 mm) Thick Panels (continued)

1.375	34,9	G1322	RG 1375-32-4	SBR	1.00	25,4	1.75	44,5	.50	12,7
1.500	38,1	G1350	RG 1500-40-4	SBR	1.25	31,8	1.88	47,6	.41	10,3
1.625	41,3	G1363	RG 1625-42-4	SBR	1.31	33,4	2.00	50,8	.44	11,1
		G1364	RG 1625-44-4	SBR	1.38	34,9	1.88	47,6	.41	10,3
1.750	44,5	G1371	RG 1750-48-4	SBR	1.50	38,1	2.13	54,0	.50	12,7
2.000	50,8	G1392	RG 2000-56-4	SBR	1.75	44,5	2.38	60,3	.38	9,5
2.500	63,5	G1423	RG 2.5-68-4	SBR	2.13	54,0	2.88	73,0	.44	11,1

For .156" (4,0 mm) Thick Panels

.500	12,7	G1094	RG 500-12-5	SBR	.38	9,5	.69	17,5	.31	8,0
.750	19,1	G1181	RG 750-16-5	SBR	.50	12,7	.94	23,8	.41	10,3
1.500	38,1	G1348	RG 1500-38-5	SBR	1.19	30,2	1.75	44,5		

For .188" (4,8 mm) Thick Panels

.312	7,9	G1022	RG 312-6-6	SBR	.19	4,8	.44	11,8	.31	8,0
.375	9,5	G1034	RG 375-6-6	SBR	.19	4,8	.63	15,9	.38	9,5
.437	11,1	G1057	RG 437-8-6	SBR	.25	6,4	.63	15,9	.31	8,0
.562	14,3	G1110	RG 562-6-6	Nitrile	.19	4,8	.75	19,1	.31	8,0
		G1115	RG 562-10-6	SBR	.31	8,0	.81	20,7	.38	9,5
		G1116	RG 562-10-6A	SBR	.31	8,0	.81	20,7	.44	11,1
		G1120	RG 562-12-6	SBR	.38	9,5	.81	20,7	.38	9,5
.625	15,9	G1133	RG 625-12-6	SBR	.38	9,5	.88	22,2	.44	11,1
		G1135	RG 625-13-6	Nitrile	.40	10,2	1.10	27,9		
.687	17,5	G1153	RG 687-14-6	SBR	.44	11,1	.94	23,8	.44	11,1
.750	19,1	G1172	RG 750-10-6	SBR	.31	8,0	1.00	25,4		
		G1194	RG 812-16-6	SBR	.50	12,7	1.06	27,0		
.812	20,6	G1199	RG 812-18-6	SBR	.56	14,3	1.06	27,0		
		G1213	RG 875-18-6	SBR	.56	14,3	1.06	27,0		
.875	22,2	G1219	RG 875-20-6	SBR	.63	15,9	1.13	28,6	.50	12,7
		G1256	RG 1000-22-6	SBR	.69	17,5	1.31	33,4		
1.000	25,4	G1261	RG 1000-24-6	SBR	.75	19,1	1.25	31,8	.56	14,3
1.062	27,0	G1272	RG 1062-24-6	SBR	.75	19,1	1.38	34,9	.50	12,7
1.250	31,8	G1306	RG 1250-28-6	SBR	.88	22,2	1.63	41,3	.56	14,3
		G1312	RG 1250-32-6	SBR	1.00	25,4	1.50	38,1	.44	11,1
1.375	34,9	G1323	RG 1375-32-6	SBR	1.00	25,4	1.75	44,5	.56	14,3
		G1329	RG 1375-36-6	SBR	1.13	28,6	1.88	47,6	.50	12,7
1.500	38,1	G1351	RG 1500-40-6	EPDM	1.25	31,8	2.00	50,8	.63	15,9
1.750	44,5	G1372	RG 1750-48-6	SBR	1.50	38,1	2.13	54,0	.56	14,3
2.000	50,8	G1390	RG 2000-52-6	SBR	1.63	41,3	2.25	57,2	.75	19,1
2.200	55,9	G1404	RG 2.200-64-6	SBR	2.00	50,8	2.75	69,9	.56	14,2
2.375	60,3	G1414	RG 2.375-64-6	PVC	2.00	50,8	2.75	69,9		

Standard color black.

Quick
Specs

Material
Temperature Range

SBR, Nitrile, EPDM, or PVC
-40°F (-40°C) to 221°F (105°C)



Heyco® Thick Panel Rubber Grommets

For Panels .250" (6,4 mm) to .375" (9,5 mm) Thick

MOUNTING HOLE DIAMETER		PART NO.	DESCRIPTION	MATERIAL	PART DIMENSIONS					
in.	mm.				A Inside Diameter		B Head Diameter		C Overall Height	
For .250" (6,4 mm) Thick Panels										
.312	7,9	G1023	RG 312-6-8	SBR	.19	4,8	.44	11,1	.38	9,5
.437	11,1	G1058	RG 437-8-8	Nitrile	.25	6,4	.63	15,9		
.500	12,7	G1086	RG 500-10-8	Nitrile	.31	8,0	.63	15,9	.63	15,9
		G1095	RG 500-12-8	SBR	.38	9,5	.75	19,1		
.562	14,3	G1117	RG 562-10-8	Nitrile	.31	8,0	.81	20,6	.50	12,7
.625	15,9	G1134	RG 625-12-8	SBR	.38	9,5	.88	22,2		
.687	17,5	G1154	RG 687-14-8	SBR	.44	11,1	.94	23,8		
.812	20,6	G1195	RG 812-16-8	SBR	.50	12,7	1.06	27,0		
		G1200	RG 812-18-8	SBR	.56	14,3				
.875	22,2	G1220	RG 875-20-8	SBR	.63	15,9	1.13	28,6		
		G1257	RG 1000-22-8	SBR	.69	17,5	1.31	33,3	.56	14,3
1.000	25,4	G1264	RG 1000-28-8	SBR	.88	22,2	1.25	31,8		
1.062	27,0	G1273	RG 1062-24-8	SBR	.75	19,1	1.38	34,9	.56	14,3
1.125	28,6	G1279*	RG 1125-26-8	SBR	.80	20,4	1.38	34,9	.51	12,9
1.250	31,8	G1301	RG 1250-24-8	SBR	.75	19,1	1.63	41,3	.44	11,1
		G1307	RG 1250-28-8	SBR	.88	22,2	1.63	41,3		
1.375	34,9	G1324	RG 1375-32-8	SBR	1.00	25,4	1.75	44,5	.63	15,9
		G1353	RG 1500-40-8	SBR	1.25	31,8	1.75	44,5		
1.500	38,1	G1354	RG 1500-40-8A	SBR	1.25	31,8	2.00	50,8	.52	13,1
		G1373	RG 1750-48-8	SBR	1.50	38,1	2.00	50,8	.50	12,7
1.750	44,5	G1374	RG 1750-48-8A	SBR	1.50	38,1	2.13	54,0		
		2.000	50,8	G1393	RG 2000-56-8	SBR	1.75	44,5	2.50	63,5
G1394	RG 2000-56-8A			Nitrile	1.75	44,5	2.50	63,5		
2.500	63,5	G1421	RG 2.5-64-8	SBR	2.00	50,8	3.00	76,2	.56	14,3
		G1425	RG 2.5-72-8	SBR	2.25	57,2	3.00	76,2		

For .375" (9,5 mm) Thick Panels

.375	9,5	G1043	RG 375-10-12	SBR	.31	8,0	.56	14,3	.50	12,7
.500	12,7	G1096	RG 500-12-12	SBR	.38	9,5	.63	15,9		
.562	14,3	G1121	RG 562-12-12	SBR	.38	9,5	.75	19,1	.75	19,1
.625	15,9	G1136	RG 625-13-12	SBR	.41	10,3	.81	20,6	.63	15,9
.750	19,1	G1182	RG 750-16-12	SBR	.50	12,7	1.00	25,4		
.875	22,2	G1214	RG 875-18-12	SBR	.56	14,3	1.06	27,0		
.968	24,6	G1232	RG 968-22-12	SBR	.69	17,4	1.31	33,3		
1.000	25,4	G1249	RG 1000-18-12	SBR	.56	14,3	1.25	31,8		
1.125	28,6	G1278	RG 1125-24-12	SBR	.75	19,1	1.63	41,3	1.13	28,6
1.250	31,8	G1308	RG 1250-28-12	Neoprene	.88	22,2	1.75	44,5	.75	19,1
		G1314	RG 1250-32-12	SBR	1.00	25,4	1.50	38,1		
1.375	34,9	G1326	RG 1375-32-12	SBR	1.00	25,4	1.75	44,5	.75	19,1
1.750	44,5	G1375	RG 1750-48-12	SBR	1.50	38,1	2.13	54,0		
2.000	50,8	G1395	RG 2000-56-12	SBR	1.75	44,5	2.50	63,5	.63	15,9
2.500	63,5	G1427	RG 2.5-72-12	SBR	2.25	57,2	3.00	76,2	.75	19,1

Standard color black. *G1279 Panel Thickness is .257" (6,5 mm)

- **Used to protect through holes.** Help eliminate sharp edges so your wires are protected and add aesthetic value to your application.
- 40 sizes available that accommodate mounting holes ranging from .312" (7,9 mm) to holes as large as 2.50" (63,5 mm) in diameter and panel thicknesses of .250" (6,4 mm) and .375" (9,5 mm).
- Rubber grommets are constructed of SBR (unless otherwise noted) with an operating temperature range of -40°F (-40°C) to 221°F (105°C).
- SBR grommets have good water resistant characteristics and are suitable for most moderate chemicals and wet or dry organic acids.
- Provide vibration dampening.

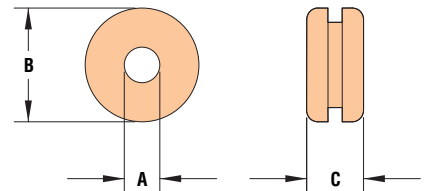

Material: SBR, Nitrile or Neoprene
 Temperature Range: -40°F (-40°C) to 221°F (105°C)

Quick Specs



- Grommet Strips protect against damage from sharp panel edges.
- Ideal for tight radii or irregular panel holes and cut-outs.



Unserrated



Serrated



Heyco® Continuous Grommet Rolls Polyethylene 100' (30.5 M) Roll

FIT PANEL THICKNESS RANGE				PART NO.		DESCRIPTION	PART DIMENSIONS					
Minimum		Maximum		Natural	Black		A Overall Height		B Bottom Thickness		C Bottom Width	
in.	mm.	in.	mm.			in.	mm.	in.	mm.	in.	mm.	
Unserrated												
.037	0,9	.071	1,8	12391	12391B	PGS-071-100'	.172	4,4	.031	0,8	.109	2,8
.072	1,8	.105	2,7	12392	12392B	PGS-105-100'						
.106	2,7	.164	4,2	12393	12393B	PGS-164-100'	.188	4,8	.047	1,2	.156	4,0
Unserrated, with Adhesive												
.037	0,9	.071	1,8	12395	12395B	PGSG-071-1-100'	.160	4,1	.025	0,6	.060	1,5
				12396	12396B	PGSG-071-2-100'	.172	4,4	.031	0,8	.109	2,8
.072	1,8	.105	2,7	12397	12397B	PGSG-105-100'	.172	4,4	.031	0,8	.109	2,8
.106	2,7	.164	4,2	12398	12398B	PGSG-164-100'	.188	4,8	.047	1,2	.156	4,0
Serrated												
.026	0,7	.036	0,9	12399	12399B	SPGS-036-100'	.125	3,2	.031	0,8	.031	0,8
.037	0,9	.071	1,8	12400	12400B	SPGS-071-100'	.172	4,4	.031	0,8	.109	2,8
.072	1,8	.105	2,7	12401	12401B	SPGS-105-100'						
.106	2,7	.164	4,2	12402	12402B	SPGS-164-100'	.188	4,8	.047	1,2	.156	4,0
Serrated, with Adhesive												
.037	0,9	.071	1,8	12405	12405B	SPGSG-071-1-100'	.160	4,1	.025	0,6	.060	1,5
				12406	12406B	SPGSG-071-2-100'	.172	4,4	.031	0,8	.109	2,8
.072	1,8	.105	2,7	12407	12407B	SPGSG-105-1-100'	.172	4,4	.031	0,8	.109	2,8

Nylon 100' (30.5 M) Roll



UNSERRATED

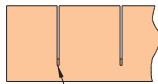

SERRATED

FIT PANEL THICKNESS RANGE				PART NO.		DESCRIPTION	PART DIMENSIONS					
Minimum		Maximum		Natural	Black		A Overall Height		B Bottom Thickness		C Bottom Width	
in.	mm.	in.	mm.			in.	mm.	in.	mm.	in.	mm.	
Unserrated												
.026	0,7	.036	0,9	12411	12411B	NGS-036-100'	.13	3,2	.03	0,8	.03	0,8
.037	0,9	.071	1,8	12412	12412B	NGS-071-100'	.17	4,4	.03	0,8	.11	2,8
Unserrated, with Adhesive												
.037	0,9	.071	1,8	12416	12416B	NGSG-071-100'	.17	4,4	.03	0,8	.11	2,8
.072	1,8	.105	2,7	12417	12417B	NGSG-105-100'						
.106	2,7	.164	4,2	12418	12418B	NGSG-164-100'	.19	4,8	.05	1,2	.16	4,0
Serrated												
.026	0,7	.036	0,9	12419	12419B	SNGS-036-100'	.13	3,2	.03	0,8	.01	0,8
.037	0,9	.071	1,8	12420	12420B	SNGS-071-100'	.17	4,4	.03	0,8	.11	2,8
.072	1,8	.105	2,7	12421	12421B	SNGS-105-100'						
.106	2,7	.164	4,2	12422	12422B	SNGS-164-100'	.19	4,8	.05	1,2	.16	4,0
Serrated, with Adhesive												
.037	0,9	.071	1,8	12426	12426B	SNGSG-071-100'	.17	4,4	.03	0,8	.11	2,8
.072	1,8	.105	2,7	12427	12427B	SNGSG-105-100'						

Standard color natural. Black available by special order only.

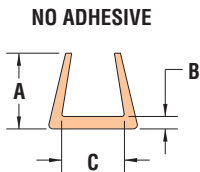

NO ADHESIVE

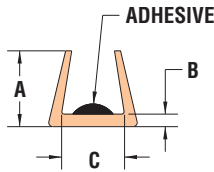

ADHESIVE

Quick Specs

Material	Polyethylene or Nylon
Flammability Rating	94HB
Temperature Range	-40°F (-40°C) to 149°F (65°C) (Polyethylene) -40°F (-40°C) to 185°F (85°C) (Nylon)

Heyco® Grommet Channels

TPE "DS" Channel - Unserrated, MDS* Filled



FIT PANEL THICKNESS RANGE				PART NO.	DESCRIPTION	PART DIMENSIONS					
Minimum		Maximum				A Overall Height	B Length				
in.	mm.	in.	mm.				in.	M.			
48" (122 cm) Strip				Gray							
.031	0,8	.062	1,6	12430	DS-062-48"	.30	7,6				
.020	0,5	.125	3,2	12431	DS-125-48"	.38	9,5				
.031	0,8	.188	4,8	12432	DS-188-48"	.50	12,7	48		1.22	
.045	1,1	.250	6,4	12433	DS-250-48"	.63	15,9				
100' (30.5 M) Roll											
.031	0,8	.062	1,6	12430R	DS-062-1200"	.30	7,6				
.020	0,5	.125	3,2	12431R	DS-125-1200"	.38	9,5	1200		30.5	

- This flexible Grommet Channel is ideal for protecting panel edges from being damaged.
- For use as wear strips, non-abrasive edging, noise-reducing conveyor strips, framing, or to protect from sharp edges.
- Good durability; MDS glue filling adheres to rubber, most plastics, wood and metal.
- Features built-in lubricant for reduced friction and longer part life.

Standard color gray.

*Cyanoacrylate adhesive, also known as "super glue", features rapid setup time.

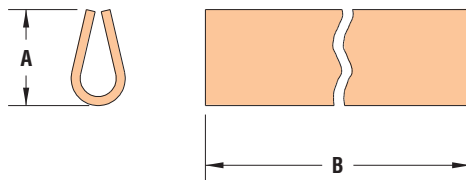

Polystyrene Channel - 4' (122 cm) Lengths

FIT PANEL THICKNESS	PART NO.	DESCRIPTION	PART DIMENSIONS								STYLE
			A Overall Height		B Top Width		C Bottom Width		D Length		
in.	mm.	White	in.	mm.	in.	mm.	in.	mm.	in.	cm.	
.050	12443	PCH-015X050-48"	.44	11,1	.02	0,4	.05	1,3			
.141	12444	PCH-020X141-48"	.56	14,3	.02	0,5	.14	3,6	48	122	
.250	12445	PCH-200X250-48"	.38	9,5	.20	5,1	.25	6,4			

- Binds and frames sharp edges.
- May be cut to desired lengths.
- Available by special order only, consult Heyco.

Standard color white.

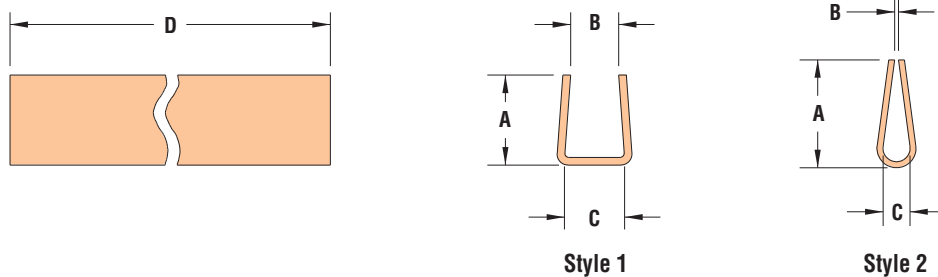

Material	PA66/6 MDS Filled Nylon or High Impact Polystyrene
Flammability Rating	94HB
Temperature Range	-40°F (-40°C) to 149°F (65°C) (DS Series) -4°F (-20°C) to 122°F (50°C) (PCH Series)

Quick Specs



Heyco® Dome Plugs

Mounting Hole Diameter Range: .187" (4,7 mm) to 2.500" (63,5 mm)

- Close unneeded panel holes and electrical knockouts.
- Quick and easy installation.
- Convex, matte finish head tapers to thin edge (Except DP-187).
- Multiple sizes for use in .187" (4,7 mm) to 6.000" (152,4 mm) diameter holes.
- Lock firmly into panel up to .250" (6,4 mm) thick.
- Locking fingers in fractional increments up to the maximum panel thickness.
- Approximate Head Thickness: .062" (1,6 mm). Thickness may vary.
- For Snap-In Metric Dome Plugs see page 6-30.

MOUNTING HOLE DIAMETER		PART NO.			DESCRIPTION	PART DIMENSIONS			
in.	mm.	Black	White	Colors xx**		A Head Diameter		B Overall Height	
					in.	mm.	in.	mm.	
Single Locking Step for Panel Thickness up to .062" (1,6 mm)									
.187	4,7	2590	2591	2592xx	DP 187*	.25	6,4	.23	5,9
.250	6,4	2607	2608	2609xx	DP 250-040†	.31	7,9	.31	7,9
		2603	2604	2605xx	DP 250				
.312	7,9	2613	2614	2615xx	DP 312	.38	9,5		
Multiple Locking Steps for Panel Thickness up to .125" (3,2 mm)									
.375	9,5	2617	2618	2619xx	DP 375	.47	11,9	.41	10,3
.437	11,1	2633	2634	2635xx	DP 437	.53	13,5		
.500	12,7	2643	2644	2645xx	DP 500	.56	14,2		
.562	14,3	2653	2654	2655xx	DP 562	.66	16,7		
.625	15,9	2663	2664	2665xx	DP 625	.72	18,2		
.687	17,4	2673	2674	2675xx	DP 687	.78	19,8		
.750	19,1	2683	2684	2685xx	DP 750	.92	23,4		
.812	20,6	2693	2694	2695xx	DP 812	.99	25,1		
.875	22,2	2703	2704	2705xx	DP 875	1.02	25,8	.45	11,5
1.000	25,4	2713	2714	2715xx	DP 1000	1.20	30,6		
1.093 - 1.125	27,8 - 28,6	2723	2724	2725xx	DP 1093	1.22	30,9		
1.187	30,1	2733	2734	2735xx	DP 1187	1.33	33,8	.47	11,9
1.250	31,7	2740	2741	2742xx	DP 1250	1.38	34,9		
1.375	34,9	2753	2754	2755xx	DP 1375	1.50	38,1		
1.500	38,1	2763	2764	2765xx	DP 1500	1.67	42,4		
1.625	41,3	2276	2277	2278xx	DP 1625	1.80	45,7		
1.750	44,5	2773	2774	2775xx	DP 1750	1.92	48,7		
1.875	47,6	2291	2292	2293xx	DP 1875	2.05	52,1	.47	11,9
2.000	50,8	2783	2784	2785xx	DP 2000	2.17	55,1		
Multiple Locking Steps for Panel Thickness up to .250" (6,4 mm)									
2.093 - 2.125	53,2 - 54,0	2403	2404	***	DP 2.093	2.34	59,9	.75	19,1
2.250	57,2	2411	2412	2413xx	DP 2.25	2.48	63,0	.75	19,1
2.500	63,5	2790	2791	2792xx	DP 2.5	2.71	68,8		

NEW!

NEW!

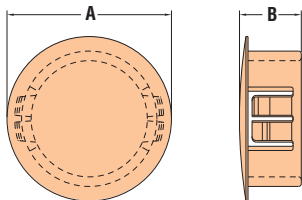

Standard colors black and white. Consult Heyco for other colors (see below)

*Convex, glossy finish head.

** xx indicates that, following the color match process, Heyco adds a two letter suffix to the Root Part No. shown. This suffix will identify your particular CUSTOM Color selection. Consult Heyco for molded nylon color chips for accurate matching. For details as well as information regarding our Stock Colors, see page 6-53.

***Consult Heyco for root Part No.

† Max panel thickness is .040" (1,0 mm)

Quick Specs

Material
Certifications



Recognized under the Component Program of Underwriters' Laboratories File E51579



Certified by the Canadian Standards Association File 8919

Flammability Rating
Temperature Range

94V-2
-40°F (-40°C) to 221°F (105°C)

“Stay Connected” with



Bushings, Grommets, HEYcaps & Plugs

a PennEngineering® Company

Heyco® Large Dome Plugs

Mounting Hole Diameter Range from 3.000" (76,2 mm) to 6.000" (152,4 mm)

Small Packs Available

MOUNTING HOLE DIAMETER		PART NO.		DESCRIPTION	PACKAGING		PART DIMENSIONS			
in.	mm.	Black	White		BULK	SMALL PACK*	A		B	
						Head Diameter	Overall Height			
						in.	mm.	in.	mm.	
Multiple Locking Steps for Panel Thickness up to .250" (6,4 mm)										
3.000	76,2	2455	2456	DP 3.0	300	10†	3.16	80,3	.74	18,8
3.375	85,7	2482	2483	DP 3.375	400	5†	3.66	92,9	.75	19,1
3.500	88,9	2464	2465	DP 3.5	200	5†	3.66	92,9		
4.000	101,6	2473	2474	DP 4.0	300	5†	4.17	105,8	.71	18,0
5.000	127,0	2451	2452	DP 5.0	150	1	5.24	133,0	.75	19,1
6.000	152,4	2453	2454	DP 6.0	130	1	6.22	157,9	.78	19,8

Standard colors black and white. Consult Heyco for other colors.

*To order Small Packs, please add the suffix -P to Part No., e.g., 2455-P

† White Small Pack quantity is 1 piece.



Heyco® Thick Panel Dome Plugs

Mounting Hole Diameter Range: .375" (9,5 mm) to 2.000" (50,8 mm)

MOUNTING HOLE DIAMETER		PART NO.		DESCRIPTION	PART DIMENSIONS			
in.	mm.	Black	White		A		B	
					Head Diameter	Overall Height		
					in.	mm.	in.	mm.
Single Locking Step for Panel Thickness up to .172" (4,4 mm)								
.375	9,5	2624	2625	DPT 375	.47	11,9	.41	10,3
Multiple Locking Steps for Panel Thickness up to .250" (6,4 mm)								
.500	12,7	3004	3005	DPT 500	.57	14,5	.56	14,3
.625	15,9	3006	3007	DPT 625 *	.73	18,5	.52	13,2
.750	19,1	3008	3009	DPT 750 *	.92	23,4		
.812	19,6	2667	2668	DPT 812-500**	1.02	25,9	.88	22,4
.875	22,2	3044	3045	DPT 875	1.02	25,9		
1.000	25,4	3046	3047	DPT 1000	1.20	30,5		
1.093 - 1.125	27,8 - 28,6	3018	3019	DPT 1093	1.22	31,0		
1.187	30,1	3100	3101	DPT 1187	1.31	33,3	.56	14,3
1.250	31,8	3102	3103	DPT 1250	1.38	35,1		
1.375	34,9	3106	3107	DPT 1375	1.50	38,1		
1.500	38,1	3048	3049	DPT 1500	1.67	42,4		
1.750	44,5	3027	3028	DPT 1750	1.91	48,5		
2.000	50,8	3050	3051	DPT 2000	2.17	55,1	.56	14,2

Standard color black. Consult Heyco for other colors.

*Single locking step for panel thickness up to .250" (6,4 mm).

**For Panel Thickness from .20" (5,1 mm) to .50" (12,7 mm). AKA Whistle-free Plug.



- For use in panels thicker than .125" (3,2 mm).
- Close unneeded panel holes and electrical knock-outs.
- Locking fingers snap into holes with fingertip pressure for quick and easy installation.
- Convex, matte finish head tapers to a thin edge.
- Locking fingers in fractional increments up to the maximum panel thickness.
- Withstand a push back force of 35 pounds.
- Available in multiple sizes for use in .375" (9,5 mm) to 2.000" (50,8 mm) diameter holes for panel thickness up to .250" (6,4 mm).
- Approximate Head Thickness: .062" (1,6 mm). Thickness may vary.

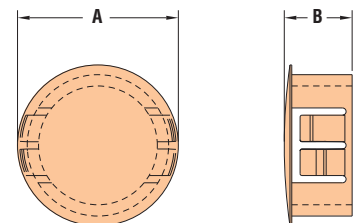

Quick Specs

Material	Nylon 6/6
Certifications	Recognized under the Component Program of Underwriters' Laboratories, File E51579 (Thick Panel Dome Plugs only) Certified by Canadian Standards Association, File 8919
Flammability Rating	94V-2
Temperature Range	-40°F (-40°C) to 221°F (105°C)



Heyco® Shorty Plugs

Single Locking Step for Panel Thickness up to: .062" (1,6 mm)
 Mounting Hole Diameter Range: .187" (4,7 mm) to 1.093" (27,8 mm)

- Limited intrusion .125" (3,2 mm) inside the panel.
- Quick and easy installation.
- Multiple sizes for mounting holes from .187" (4,7 mm) to 1.093" (27,8 mm).
- Approximate Head Thickness: .062" (1,6 mm).
- For Shorty Window Plugs see page 6-36.

MOUNTING HOLE DIAMETER		PART NO.			DESCRIPTION	PART DIMENSIONS			
in.	mm.	Black	White	Colors xx*		A Head Diameter		B Overall Height	
						in.	mm.	in.	mm.
.187	4,7	2590	2591	2592xx	DP 187†	.25	6,4	.23	5,9
.218	5,5	1654	1655	1656xx	SP 218	.28	7,1	.25	6,4
.281	7,1	1660	1661	1662xx	SP 281	.34	8,7		
NEW! .307	7,8	1657	1658	1659xx	SP 307	.37	9,4		
.312	7,9	1678	1679	1680xx	SP 312	.38	9,5		
.343	8,7	1663	1664	1665xx	SP 343	.41	10,3		
NEW! .375	9,5	1681	1682	1683xx	SP 375	.47	11,9		
.390	9,9	1708	1709	1710xx	SP 390				
.406	10,3	1666	1667	1668xx	SP 406				
.437	11,1	1684	1685	1686xx	SP 437	.53	13,5		
.468	11,9	1669	1670	1671xx	SP 468				
.500	12,7	1687	1688	1689xx	SP 500	.56	14,3		
.531	13,5	1672	1673	1674xx	SP 531	.59	15,1		
.593	15,1	1675	1676	1677xx	SP 593	.69	17,5		
.625	15,9	1690	1691	1692xx	SP 625	.72	18,3		
NEW! .687	17,4	1719	1720	1721xx	SP 687	.79	20,1		
.750	19,0	1693	1694	1695xx	SP 750	.84	21,4		
.781	19,8	1696	1697	1698xx	SP 781	.89	22,6		
.875	22,2	1699	1700	1701xx	SP 875	.97	24,6		
1.000	25,4	1702	1703	1704xx	SP 1000	1.20	30,5		
1.093	27,8	1705	1706	1707xx	SP 1093	1.22	31,0		

Standard colors black or white. Consult Heyco for other colors (see below).

† Convex, glossy finish head.

*xx indicates that, following the color match process, Heyco adds a two letter suffix to the Root Part No. shown. This suffix will identify your particular CUSTOM Color selection. Consult Heyco for molded nylon color chips for accurate matching. For details as well as information regarding our Stock Colors, see page 6-53.

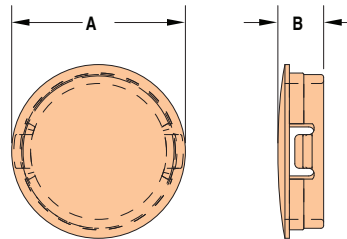

Quick Specs

Material
 Certifications

Nylon 6/6



Recognized under the Component Program of Underwriters' Laboratories File E51579



Certified by the Canadian Standards Association File 8919

Flammability Rating
 Temperature Range

94V-2

-40°F (-40°C) to 221°F (105°C)

“Stay Connected” with



Bushings, Grommets, HEYcaps & Plugs

a PennEngineering® Company



Heyco® Thin Panel Dome Plugs

Multiple Locking Steps for Panels as Thin as .020" (0,5 mm)
Mounting Hole Diameter Range: .218" (5,5 mm) to .875" (22,2 mm)*

PANEL DIMENSIONS				PART NO.		DESCRIPTION	PART DIMENSIONS			
Thickness at Locking		Mounting Hole Diameter*		Black	White		A		B	
Finger Steps							Head Diameter		Overall Height	
in.	mm.	in.	mm.			in.	mm.	in.	mm.	

Three Steps to .048" (1,2 mm) thick

.020 .032 .048	0,5 0,8 1,2	.218	5,5	1654N	1655N	SP 218N	.28	7,1	.25	6,4
		.250	6,4	2607N	2608N	SP 250N	.31	7,9		
		.281	7,1	1660N	1661N	SP 281N	.34	8,7		
		.312	7,9	1678N	1679N	SP 312N	.38	9,5		
		.343	8,7	1663N	1664N	SP 343N	.41	10,3		
		.375	9,5	1681N	1682N	SP 375N	.47	11,9		

Five Steps to .064" (1,6 mm) thick

.020 .032 .040 .048 .064	0,5 0,8 1,0 1,2 1,6	.500	12,7	1687N	1688N	SP 500N	.56	14,3	.25	6,4
		.512	13,0	1716N	1717N	SP 512N				
		.625	15,9	1690N	1691N	SP 625N				
		.750	19,1	1693N	1694N	SP 750N				
		.875	22,2	1699N	1700N	SP 875N				

Standard color black. Consult Heyco for other colors.

*Consult Heyco for other Mounting Hole Diameters. Our Axcell Rapid Response Team is ready to meet your requirements.

- Provide a flush, finished fit in panels as thin as .020" (0,5 mm).
- Quick and easy installation.
- Multiple sizes for mounting holes from .218" (5,5 mm) to .875" (22,2 mm).
- Consult Heyco for other Thin Panel Mounting Hole Diameters.
- Lock firmly in panels up to .064" (1,6 mm) thick.

NEW!

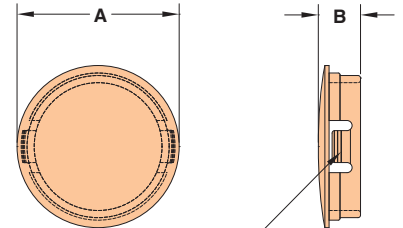

MULTIPLE FINGER STEPS FOR TIGHT PANEL FIT

Heyco® Thin Panel versus Shorty Plugs

Choose from Multiple Locking Steps, for the Fit and Finish Your Application Requires

Mounting Hole Diameter	PANEL DIMENSIONS					PART NO.		DESCRIPTION	
	Maximum Thickness Locking Steps					Black	White		
	inches/millimeters								
in.	mm.	.020 0,5	.032 0,8	.040 1,0	.048 1,2	.064 1,6			
.218	5,5	x	x		x		1654N	1655N	SP 218N
						x		1654	1655
.250	6,4	x	x		x		2607N	2608N	SP 250N
							x	1660N	1661N
.281	7,1						1660	1661	SP 281
		x	x		x			1666N	1667N
.312	7,9						1678N	1679N	SP 312N
							x	1678	1679
.343	8,7	x	x		x		1663N	1664N	SP 343N
							x	1663	1664
.375	9,5	x	x		x		1681N	1682N	SP 375N
							x	1681	1682
.500	12,7	x	x	x	x	x	1687N	1688N	SP 500N
								1687	1688
.625	12,7	x	x	x	x	x	1690N	1691N	SP 625N
								1690	1691
.750	19,1	x	x	x	x	x	1693N	1694N	SP 750N
								1693	1694
.875	22,2	x	x	x	x	x	1699N	1700N	SP 875N
								1699	1700

Material Certifications



Nylon 6/6
Recognized under the Component Program of Underwriters' Laboratories, File E51579



Certified by Canadian Standards Association, File 8919

Flammability Rating
Temperature Range

94V-2
-40°F (-40°C) to 221°F (105°C)

Quick Specs

“Stay Connected” with



Bushings, Grommets, HEYcaps & Plugs

a PennEngineering® Company



- **Molded from a nylon material which, in the event of a fire, will not burn and will not produce toxic gases.** Also formulated for sunlight resistance. Other Heyco products are available in this material—please consult Heyco.
- Close unneeded panel holes.
- Quick and easy installation.
- Convex, matte finish head tapers to a thin edge (Except HFP-187 glossy finish).
- Lock firmly into panel up to .125" (3,2 mm) thick.
- Locking fingers in fractional increments up to the maximum panel thickness.
- Approximate Head Thickness: .062" (1,6 mm). Thickness may vary.
- Multiple sizes for use in .187" (4,7 mm) to 2.000" (50,8 mm) diameter holes. Consult Heyco for larger sizes.

Heyco® Halogen and Phosphorus-Free 94V-0 Hole Plugs

Heat Stabilized • Self Extinguishing • Nontoxic • UV Resistant

Mounting Hole Diameter Range: .187" (4,7 mm) to 2.000" (50,8 mm)

MOUNTING HOLE DIAMETER		PART NO. Black	DESCRIPTION	PART DIMENSIONS			
in.	mm.			A Head Diameter		B Overall Height	
				in.	mm.	in.	mm.

Single Locking Step for Panel Thickness up to .062" (1,6 mm)

.187	4,7	2593	HFP 187*	.25	6,4	.24	6,1
.250	6,4	2606	HFP 250	.31	7,9		
.312	7,9	2616	HFP 312	.38	9,5	.31	7,9

Multiple Locking Steps for Panel Thickness up to .125" (3,2 mm)

.375	9,5	2623	HFP 375	.47	11,9	.41	10,3
.437	11,1	2636	HFP 437	.53	13,5		
.500	12,7	2646	HFP 500	.58	14,7		
.625	15,9	2666	HFP 625	.72	18,2		
.750	19,1	2686	HFP 750	.92	23,4	.45	11,5
.875	22,2	2706	HFP 875	1.02	25,8		
1.000	25,4	2716	HFP 1000	1.20	30,6		
1.093 - 1.125	27,8 - 28,6	2729	HFP 1093	1.22	30,9		
1.250	31,7	2749	HFP 1250	1.38	34,9	.47	11,9
1.375	34,9	2759	HFP 1375	1.50	38,1		
1.500	38,1	2769	HFP 1500	1.69	42,8		
1.750	44,5	2779	HFP 1750	1.92	48,7		
2.000	50,8	2789	HFP 2000	2.17	55,1		

Multiple Locking Steps for Panel Thickness up to .250" (6,4 mm)

ALL NEW PRODUCTS

.500	12,7	3004F	HFPT 500	.58	14,7	.56	14,3
.625	15,9	3006F	HFPT 625 *	.73	18,5	.52	13,2
.750	19,1	3008F	HFPT 750 *	.91	23,1	.56	14,3
.875	22,2	3044F	HFPT 875	1.02	25,8		
1.000	25,4	3046F	HFPT 1000	1.20	30,6		
1.093- 1.125	27,8- 28,6	3018F	HFPT 1093	1.22	30,9		
1.250	31,7	3102F	HFPT 1250	1.38	34,9	.58	14,7
1.375	34,9	3106F	HFPT 1375	1.50	38,1		
1.500	38,1	3048F	HFPT 1500	1.67	42,4		
1.750	44,5	3027F	HFPT 1750	1.91	48,4		
2.000	50,8	3050F	HFPT 2000	2.17	55,1		

Standard color black.
*Convex, glossy finish head.

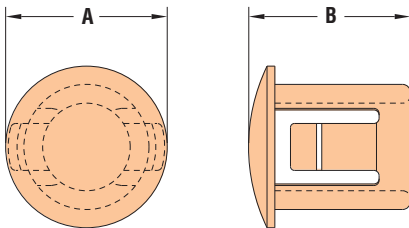

SINGLE PANEL THICKNESS DESIGN

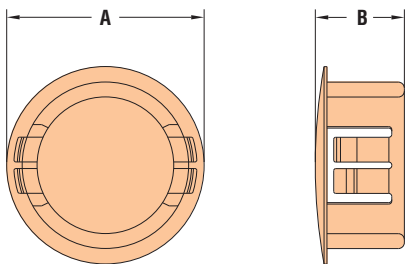

MULTIPLE PANEL THICKNESS DESIGN

Quick Specs

Material
Certifications

Nylon 6/6
 Recognized under the Component Program of Underwriters' Laboratories File E51579

Flammability Rating
Temperature Range

Certified by the Canadian Standards Association File 8919
 94V-0
 -40°F (-40°C) to 221°F (105°C)

“Stay Connected” with



Bushings, Grommets, HEYcaps & Plugs

a PennEngineering® Company



Heyco® Extra Dome Plugs

Multiple Locking Steps for Panel Thickness up to .250" (6,4 mm)

MOUNTING HOLE DIAMETER		PART NO.		DESCRIPTION	PART DIMENSIONS					
		Black	White		A Head Diameter		B Overall Height		C Inside Height	
in.	mm.				in.	mm.	in.	mm.	in.	mm.
3.0	76,2	2442	2443	EDP 3.0	3.22	81,8	1.37	34,8	1.26	32,0
5.0	127,0	2444	2445	EDP 5.0	5.22	132,6	1.41	35,8	1.31	33,3

Standard colors black. Consult Heyco for other colors.

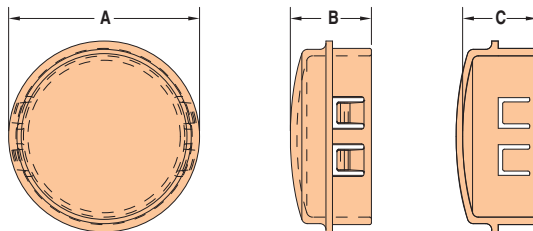

- Extra dome height for additional clearance under the top.
- Consult Heyco for additional sizes.
- Lock firmly into panels up to .250" (6,4 mm) thick.
- Locking fingers in fractional increments up to the maximum panel thickness.
- Not UL Recognized.



Heyco® Snap-In Metric Dome Plugs

Multiple Locking Steps for Panel Thickness up to 4,1 mm (.162")

Mounting Hole Diameter Range: 13,0 mm (.512") to 34,2 mm (1.347")

	MOUNTING HOLE DIAMETER		PART NO.		DESCRIPTION	PART DIMENSIONS			
	mm.	in.	Black	White		A Head Diameter		B Overall Height	
						mm.	in.	mm.	in.
NEW!	13,0	.512	2203	2204	MDP 13	14,2	.56		
	16,0	.630	2128	2130	MDP 16	18,5	.73	10,3	.406
	20,0	.787	2131	2132	MDP 20	22,6	.89		
NEW!	22,0	.866	2205	2206	MDP 22	25,9	1.02		
	25,0	.984	2133	2134	MDP 25	29,8	1.17		
NEW!	28,0	1.102	2215	2216	MDP 28	31,2	1.23	11,5	.453
	32,0	1.260	2135	2136	MDP 32	35,3	1.38		
NEW!	34,2	1.347	2218	2219	MDP 34	38,1	1.50		

Standard color black. Consult Heyco for other colors.

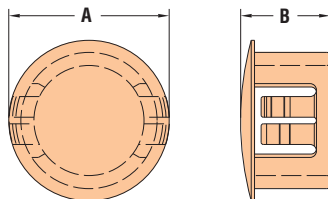

- Multiple sizes for use in **13,0 mm (.512") to 34,2 mm (1.347") diameter holes**. For other metric sizes, consult Heyco.
- Close unneeded panel holes.
- Quick and easy installation.
- Convex, matte finish head tapers to a thin edge.
- Lock firmly into panel up to 4,1 mm (.162") thick.
- Approximate Head Thickness: 1,6 mm (.062").
- For **Threaded Metric Plugs**, see page 6-44.
- For our complete range of Dome Plugs, see pages 6-25 and 6-26.

Material Certifications



Nylon 6/6
Recognized under the Component Program of Underwriters' Laboratories, File E51579 (MDP's only)



Certified by Canadian Standards Association, File 8919 (MDP's only)

Flammability Rating
Temperature Range

94V-2
-40°F (-40°C) to 221°F (105°C)

Quick Specs



- **Smooth, glossy head** provides easy glide and shiny finish.
- Close unneeded panel openings.
- Locking fingers snap into holes with fingertip pressure for quick and easy installation.
- Locking fingers in fractional increments up to the maximum panel thickness.
- Multiple sizes for use in .187” (4,7 mm) to 2.000” (50,8 mm) diameter holes.
- Lock firmly in panel up to .125” (3,2 mm) thick. (G parts)
- For use in panels thicker than .125” (3,2 mm). (GPT parts)
- Withstand a push back force of 35 pounds.

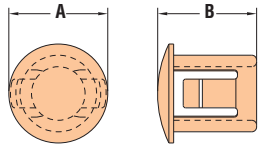

SINGLE PANEL THICKNESS DESIGN

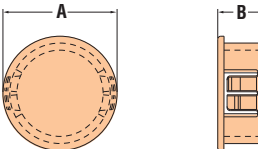

MULTIPLE PANEL THICKNESS DESIGN

Heyco® Glossy and Thick Panel Glossy Plugs

Mounting Hole Diameter Range: .187” (4,7 mm) to 2.000” (50,8 mm)

MOUNTING HOLE DIAMETER in. mm.	PART NO.		DESCRIPTION	PART DIMENSIONS				
	Black	White		A Head Diameter in. mm.		B Overall Height in. mm.		
Single Locking Step for Panel Thickness up to .062” (1,6 mm)								
.187	4,7	2590	2591	DP 187*	.25	6,4	.23	5,9
.250	6,4	2600	2601	G 250	.31	7,9	.31	7,9
.312	7,9	2610	2611	G 312	.38	9,5		
Multiple Locking Steps for Panel Thickness up to .125” (3,2 mm)								
.375	9,5	2620	2621	G 375	.47	11,9	.41	10,3
.437	11,1	2630	2631	G 437	.53	13,5		
.500	12,7	2640	2641	G 500	.56	14,3		
.562	14,3	2650	2651	G 562	.66	16,7		
.625	15,9	2660	2661	G 625	.73	18,6		
.750	19,1	2680	2681	G 750	.86	21,8	.45	11,5
.875	22,2	2700	2701	G 875	.95	24,2		
1.000	25,4	2710	2711	G 1000	1.13	28,6		
1.093 - 1.125	27,8 - 28,6	2720	2721	G 1093	1.22	30,9		
1.187	30,1	2730	2731	G 1187	1.31	33,3		
1.375	34,9	2760	2761	G 1375	1.49	37,7	.56	14,3
1.500	38,1	2770	2771	G 1500	1.61	40,8		
1.750	44,4	2780	2781	G 1750	1.88	47,6		
2.000	50,8	2795	2796	G 2000	2.13	54,8		
Multiple Locking Steps for Panel Thickness up to .250” (6,4 mm)								
.500	12,7	2430	2431	GPT 500	.56	14,3	.56	14,3
.625	15,9	3134	3135	GPT 625**	.72	18,3	.52	13,1
.750	19,1	3136	3137	GPT 750**	.85	21,6		
.875	22,2	3138	3139	GPT 875	.95	24,2	.56	14,3
1.000	25,4	3140	3141	GPT 1000	1.13	28,6		
1.093 - 1.125	27,8 - 28,6	3142	3143	GPT 1093	1.22	30,9		
1.187	30,1	3144	3145	GPT 1187	1.31	33,3		
1.375	34,9	2432	2433	GPT 1375	1.49	37,7		
1.500	38,1	2428	2429	GPT 1500	1.61	40,8	.52	13,1
1.750	44,4	2436	2437	GPT 1750	1.88	47,6		
2.000	50,8	2438	2439	GPT 2000	2.16	54,8		

Standard color black. Consult Heyco for other colors.

*Convex, glossy finished head tapers to a thin edge.

** Single locking steps for Panel Thickness up to .250” (6,4 mm)

Quick Specs

Material Certifications



Nylon 6/6
Recognized under the Component Program of Underwriters' Laboratories, File E51579



Certified by Canadian Standards Association, File 8919

Flammability Rating
Temperature Range

94V-2
-40°F (-40°C) to 221°F (105°C)

“Stay Connected” with



Bushings, Grommets, HEYcaps & Plugs

a PennEngineering® Company



Heyco® Pry Out Plugs

Standard Finger Design

Mounting Hole Diameter Range: .250" (6,4 mm) to 2.500" (63,5 mm)

MOUNTING HOLE DIAMETER		PART NO.		DESCRIPTION	PART DIMENSIONS				
		Black	White		A Head Diameter		B Overall Height		
in.	mm.				in.	mm.	in.	mm.	
Clearance Fit for Panel Thickness up to .156" (4,0 mm)									
.250	6,4	3053	3054	POP 250	.42	10,7	.33	8,3	
Clearance Fit for Panel Thickness up to .172" (4,4 mm)									
.312	7,9	3056	3057	POP 312	.51	12,9			
.375	9,5	3059	3060	POP 375	.58	14,7			
.437	11,1	3062	3063	POP 437	.61	15,5			
.500	12,7	3065	3066	POP 500	.67	17,0			
.562	14,3	3068	3069	POP 562	.73	18,6			
.625	15,9	3071	3072	POP 625	.80	20,2			
.687	17,4	3074	3075	POP 687	.89	22,6	.41	10,4	
.750	19,0	3077	3078	POP 750	.97	24,6			
.812	20,6	3080	3081	POP 812	1.03	26,2			
.875	22,2	3083	3084	POP 875	1.08	27,4			
1.000	25,4	3086	3087	POP 1000	1.22	30,9			
1.093	27,8	3089	3090	POP 1093	1.30	32,9			
1.187	30,1	3092	3093	POP 1187	1.41	35,7			
1.250	31,8	3095	3096	POP 1250	1.45	36,9			
1.375	34,9	3098	3099	POP 1375	1.58	40,1	.45	11,5	
Clearance Fit for Panel Thickness up to .250" (6,4 mm)									
1.500	38,1	3124	3125	POP 1500	1.72	43,6	.45	11,5	
1.750	44,5	2973	2974	POP 1750	1.98	50,3	.48	12,2	
2.000	50,8	2798	2799	POP 2000	2.22	56,4	.48	12,2	
2.500	63,5	2975	2976	POP 2.5	2.69	68,4	.74	18,8	

Standard color black. Consult Heyco for other colors.

Prong Finger Design

Mounting Hole Diameter Range: .187" (4,7 mm) to .375" (9,5 mm)



WILL FIT THESE PANELS						PART NO.		DESCRIPTION	HEAD STYLE	PART DIMENSIONS					
MOUNTING HOLE DIAMETER		THICKNESS RANGE		Black	Natural	A Head Diameter				B Overall Height					
Minimum	Maximum	Minimum	Maximum			in.	mm.	in.	mm.						
.187	4,7	.192	4,9	.031	0,8	.062	1,6	12170	12171	PPL 187	Glossy	.35	8,9	.18	4,6
.313	8,0	.318	8,1	.047	1,2	.156	4,0	12178	12179	PPL 313	Dome	.58	14,7	.41	10,4
.375	9,5	.380	9,7	.093	2,4	.312	7,9	12182	12183	PPL 375	Glossy	.19	12,4	.53	13,5

Standard color black and natural.

Material	Nylon 6/6
Certifications	Recognized under the Component Program of Underwriters' Laboratories, File E51579 (POP Plugs only) Certified by the Canadian Standards Association, File 8919 (POP Plugs only)
Flammability Rating	94V-2
Temperature Range	-40°F (-40°C) to 221°F (105°C) (POP Plugs only) 32°F (0°C) to 185°F (85°C) (PPL Plugs only)

- POP in closures for pipe and tubing ends.
- Retaining fingers without locking steps provide friction fit and allow removal of plug.
- Bumper protection.
- Flat, matte finish head.
- Multiple sizes for use in .250" (6,4 mm) to 2.500" (63,5 mm) diameter holes for panel thickness up to .250" (6,4 mm).
- Approximate Head Thickness: .062" (1,6 mm).

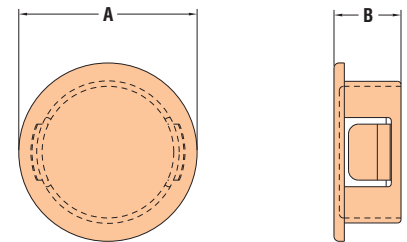

- Flexible and tapered prongs on plug will snugly lock in place with fingertip pressure, but can be removed & reused.
- Durable and non-conductive.
- Excellent dust protection for electronic equipment.
- Abrasion and vibration resistant.
- May be used as temporary or permanent hole plugs.
- Function as feet on small appliances.
- May be used to close tube ends.

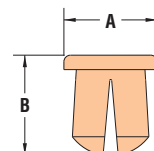



- Close unneeded sheet metal panel holes, *ergonomically*.
- Flush button head style.
- Quick, easy installation; quick, easy removal, too.
- Heyco Metric Ergonomic Plugs offer greater versatility because their pliable nature allows one plug size to fit a variety of different sized holes.
- UV resistant material allows plugs to be suitable for outdoor exposure (sunlight resistant).
- Available in multiple sizes from 14,5 mm (.57”) through 34,0 mm (1.34”) diameter holes.

Heyco® Metric Ergonomic Plugs

For Panel Thickness from 0,8 mm (.03”) to 2,0 mm (.08”)
 Mounting Hole Diameter Range: 14,5 mm (.57”) to 34,0 mm (1.34”)

MOUNTING HOLE DIAMETER NOMINAL	DIAMETER RANGE		PART NO.	DESCRIPTION	PART DIMENSIONS				C	
	mm.	mm.			in.	A Head Diameter		B Bottom Diameter		mm.
15	14,5 - 16,0	.57 - .63	9690	SMP E-M15	25,0	.98	18,0	.71	7,8	.31
17	15,2 - 18,0	.65 - .71	9691	SMP E-M17	28,0	1.10	20,3	.80		
19	18,5 - 20,0	.73 - .79	9692	SMP E-M19	30,2	1.19	22,5	.89		
21	20,5 - 22,0	.81 - .87	9693	SMP E-M21	32,0	1.26	24,3	.96		
23	22,5 - 24,0	.87 - .95	9694	SMP E-M23	34,0	1.34	26,4	1.04		
25	24,5 - 26,0	.97 - 1.02	9695	SMP E-M25	35,0	1.38	28,0	1.10		
27	26,5 - 28,0	1.04 - 1.10	9696	SMP E-M27	38,0	1.50	30,3	1.19		
29	28,5 - 30,0	1.12 - 1.18	9697	SMP E-M29	40,0	1.58	32,3	1.27		
31	30,5 - 32,0	1.20 - 1.26	9698	SMP E-M31	42,0	1.65	34,3	1.35		
33	32,5 - 34,0	1.28 - 1.34	9699	SMP E-M33	44,0	1.73	36,3	1.43		

Standard color black.

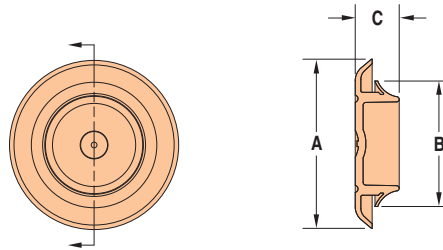

- Closes cavity-fill insulation holes in wood and other type siding.
- Fills holes in surfaces of unspecified thickness including cabinetry, furniture, display cases—even masonry.
- Convex, matte finish head blends with various surfaces.
- Quick and easy installation with fingertip pressure (no tool required).
- Holds securely in hole.

Heyco® Insulation Plug

No Maximum Panel Thickness

MOUNTING HOLE DIAMETER		PART NO.		DESCRIPTION	PART DIMENSIONS			
in.	mm.	Black	White		A Head Diameter		B Overall Height	
1.000	25,4	3149	3150	IPW 1	1.23	31,3	.69	17,5

Standard color black. Consult Heyco for other colors.

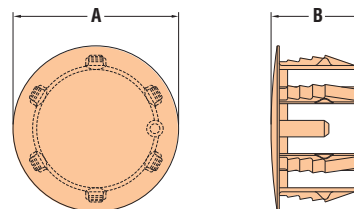

Quick Specs

Material	SMP E Flex Temp (Thermoplastic Rubber)
Material	IPW Nylon 6/6
Flammability Rating	94V-2
Temperature Range	(Both) -40°F (-40°C) to 221°F (105°C)

“Stay Connected” with



Bushings, Grommets, HEYcaps & Plugs

a PennEngineering® Company



Heyco® Double D Hole Plugs

For Mounting Holes with Flats

Multiple Locking Steps for Panel Thickness up to .125" (3,2 mm)

PANEL DIMENSIONS				PART NO.		DESCRIPTION	PART DIMENSIONS			
D		C		Black	White		A		B	
Mounting Hole Dia.		To Prevent Rotation						Head Diameter		Overall Height
in.	mm.	in.	mm.			in.	mm.	in.	mm.	
.375	9,5	.345	8,8	2617	2618	DP 375*	.47	11,9		
.437	11,1	.390	9,9	2488	2489	DD 437-390	.53	13,5		
.500	12,7	.445	11,3	2491	2492	DD 500-445	.55	14,7	.41	10,3
.562	14,3	.530	13,5	2494	2495	DD 562-530	.66	16,7		
.625	15,9	.550	14,0	2497	2498	DD 625-550	.73	18,5		
.750	19,1	.625	15,9	2503	2504	DD 750-625	.92	23,4		
.875	22,2	.770	19,5	2509	2510	DD 875-770	1.02	25,8		
				2511	-	DD 875-770-9**	.94	23,8	.45	11,5
1.109	28,2	1.000	25,4	2717	2718	DD 1109-1000	1.22	30,9		
2.000	50,8	1.875	47,6	2959	2963	DD 2000-1875	2.17	55,1	.48	12,1

Standard colors black and white. Consult Heyco for other colors.

*On installation, DP 375 Locking Fingers must be aligned with Mounting Hole Flats.

**Smaller than standard Head Diameter, for clearance situations.

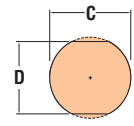
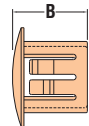
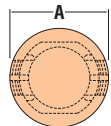

MOUNTING HOLE

DD Series

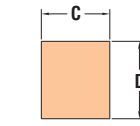
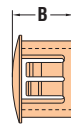
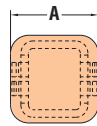

MOUNTING HOLE

RP Series

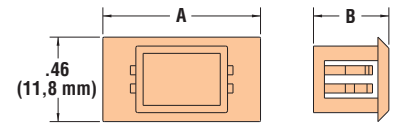

3299, 3388, 3389

Heyco® Rectangular Blanking & Connector Port Plugs

Multiple Locking Steps for Various Panel Thicknesses

Maximum Thickness	PANEL DIMENSIONS				PART NO.	DESCRIPTION	PART DIMENSIONS				
	Mounting Hole		C Length	D Width			Black	A Head Dimensions		B Overall Height	
in.	mm.	in.			mm.	in.		mm.	in.	mm.	in.
Rectangular Blanking Plugs											
.025	0,64	.964	24,5	.964	24,5	13910	RP 245-245	1.06 x 1.06	26,9 x 26,9		
						13911	RB 245-245*	1.05 x 1.05	26,7 x 26,7	.30	7,6
.04	1,0	.27	6,9	.29	7,4	2512	RP 69-74	.37 x .37	9,4 x 9,4	.33	8,4
.10	2,5	.45	11,5	.51	13,9	1890	RP 115-130	.58 x .58	14,7 x 14,7	.40	10,2
.16	4,0	.69	17,5	.69	17,5	1892	RP 175-175	.83 x .83	21,1 x 21,1	.47	11,9

Connector Port Plugs

.14	3,5	.37	9,5	.51	13,0	3299	RP 95-130-1	.63	16,0	.41	10,5
						3388	RP 95-130	.87	22,0		
				1.02	26,0	3389	RP 95-260	1.38	35,0		

Standard color black.

*Bushing version of the above plug.

Material
Certifications

Nylon 6/6
 Recognized under the Component Program of Underwriter Laboratories File E51579 (DD only)

Flammability Rating
Temperature Range

94V-2
-40°F (-40°C) to 221°F (105°C)

- Blank unused rectangular panel holes.
- **PN 1890** - UR Recognized under the Component Program of Underwriters' Laboratories File E15331.
- **PN 1892** - UR Recognized under the Component Program of Underwriters' Laboratories File E51579 and CSA Certified by the Canadian Standards Association File 8919.

NEW!
NEW!

NEW!

Quick
Specs

“Stay Connected” with



Bushings, Grommets, HEYcaps & Plugs

a PennEngineering® Company



Consult Heyco for Window Tints Other Than Clear

Heyco® Window “View Port” Plugs

Mounting Hole Diameter Range: .187” (4,7 mm) to 2.000” (50,8 mm)

- Molded of **transparent** polycarbonate for internal viewing or light transmission.
- Snap into mounting holes with fingertip pressure—no tools required.
- Multiple sizes for use in .187” (4,7 mm) to 2.000” (50,8 mm) diameter holes.
- Lock firmly into panel up to .125” (3,2 mm) thick.
- Locking fingers in fractional increments up to the maximum panel thickness.
- Approximate Head Thickness: .062” (1,6 mm). Thickness may vary.
- **Available in a variety of tints –consult Heyco.**

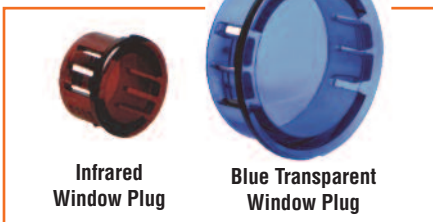

Infrared Window Plug

Blue Transparent Window Plug

MOUNTING HOLE DIAMETER		PART NO. Clear*	DESCRIPTION	PART DIMENSIONS			
in.	mm.			A Head Diameter		B Overall Height	
Single Locking Step for Panel Thickness up to .062” (1,6 mm)							
.187	4,7	1300	WP 187	.25	6,4	.23	5,9
.250	6,4	1301	WP 250	.31	7,9	.31	7,9
.312	7,9	1302	WP 312	.38	9,5		
Multiple Locking Steps for Panel Thickness up to .125” (3,2 mm)							
.375	9,5	1303	WP 375	.47	11,9	.41	10,3
.437	11,1	1304	WP 437	.53	13,5		
.500	12,7	1305	WP 500	.56	14,3		
.625	15,9	1307	WP 625	.73	18,6		
.760	19,3	1309	WP 750	.86	21,8	.45	11,5
.875	22,2	1311	WP 875	.95	24,2		
1.000	25,4	1312	WP 1000	1.13	28,6		
1.093 - 1.125	27,8 - 28,6	1313	WP 1093	1.22	30,9		
1.375	34,9	1314	WP 1375	1.50	38,1		
1.500	38,1	1316	WP 1500	1.62	41,2		
1.750	44,5	1318	WP 1750	1.88	47,6		
2.000	50,8	1319	WP 2000	2.16	54,8		

*Consult Heyco for Window Plugs in tinted colors.

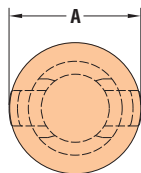

SINGLE PANEL THICKNESS DESIGN

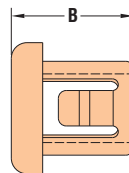

MULTIPLE PANEL THICKNESS DESIGN

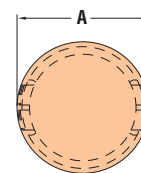

- Matte Finish diffuses light from source behind plug.

ALL NEW PRODUCTS!

Heyco® Diffuser Plugs

MOUNTING HOLE DIAMETER*		PART NO. Matte	DESCRIPTION	PART DIMENSIONS			
in.	mm.			A Head Diameter		B Overall Height	
Multiple Locking Steps for Panel Thickness up to .125” (3,2 mm)							
.760	19,3	1309D	DWP 750	.86	21,8	.41	10,3
1.000	25,4	1312D	DWP 1000	1.13	28,6	.45	11,5
2.000	50,8	1319D	DWP 2000	2.16	54,8		

*Consult Heyco for other mounting hole diameters.

Material	Polycarbonate
Flammability Rating	94V-2
Temperature Range	-40°F (-40°C) to 239°F (115°C)

Quick Specs

Heyco® Shorty Window “View Port” Plugs

Single Locking Step for Panel Thickness up to .062” (1,6 mm)
 Mounting Hole Diameter Range: .510” (13,0 mm) to 1.010” (25,7 mm)

MOUNTING HOLE DIAMETER		PART NO.	DESCRIPTION	PART DIMENSIONS			
in.	mm.			Clear*	A Head Diameter		B Overall Height
.510	13,0	1292	SWP 510	.56	14,3	.25	6,4
.635	16,1	1293	SWP 635	.73	18,6		
.760	19,3	1294	SWP 760	.86	21,8		
.885	22,5	1295	SWP 885	.95	24,2		
1.010	25,7	1296	SWP 1010	1.13	28,6		

*Consult Heyco for Shorty Window Plugs in tinted colors.

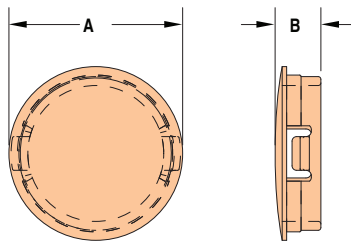

Heyco® Oval Window “View Port” Plug

Multiple Locking Steps for Panel Thickness up to .125” (3,2 mm)

MOUNTING HOLE DIAMETER		PART NO.	DESCRIPTION	PART DIMENSIONS			
in.	mm.			Clear*	Head Diameter		Overall Height
see schematic		1299	OWP 875-2000	2.13 - 1.01	54,4 - 26,6	.46	11,7

*Consult Heyco for Oval Window Plugs in tinted colors.

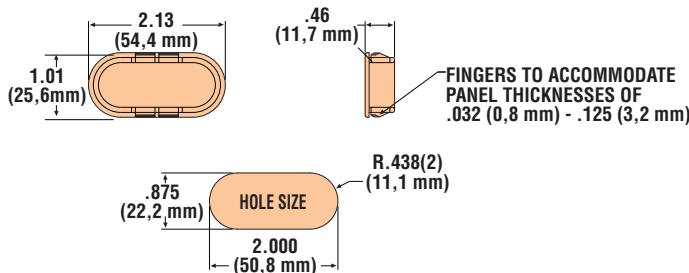

- Lock firmly into panels up to .062” (1,6 mm) thick, with **limited intrusion** inside the panel.
- Molded of transparent polycarbonate for internal viewing or light transmission.
- Snap into mounting holes with fingertip pressure—no tools required.
- Locking fingers in fractional increments up to the maximum panel thickness.
- Multiple sizes for use in .510” (13,0 mm) to 1.010” (25,7 mm) diameter holes.
- Flammability Rating 94V-2.
- **Available in a variety of tints—consult Heyco.**



- **Large viewing window** for internal components.
- Locking fingers in fractional increments up to the maximum panel thickness.

Consult Heyco for Window Tints Other Than Clear

Material	Polycarbonate
Flammability Rating	94V-2
Temperature Range	-40°F (-40°C) to 239°F (115°C)

Quick Specs



Heyco® Nylon Knock Out Seals and Thick Panel Knock Out Seals

Consult Heyco for our Complete Line of Dome Plugs

Mounting Hole Diameter Range: 1/2" to 2" Electrical Knock-outs (.875" to 2.500" nominal)

- **Plug electrical knock-outs.**
- Molded in silver gray color to resemble galvanized steel.
- Install quickly with fingertip pressure (no tool required).
- Economical.
- Multiple trade sizes fit 1/2" to 2" knock-out holes.
- Lock firmly in boxes up to 1/8" thick, except for Part Number 4002 (KOS 2) and Thick Panel Knock-Out Seals (KOST's) which lock firmly in boxes up to 1/4" thick.
- Locking fingers in fractional increments up to the maximum panel thickness.
- Approximate Head Thickness: .06" (1,6 mm). Thickness may vary.
- To adapt a Knock-Out to accept a Heyco Strain Relief, see page 4-37 for Knock-Out Adapters in the Heyco Catalog .

MOUNTING HOLE DIAMETER		TRADE SIZE	PART NO. Silver Gray	DESCRIPTION	PART DIMENSIONS			
in.	mm.				A Head Diameter		B Overall Height	
					in.	mm.	in.	mm.

Multiple Locking Steps for Panel Thickness up to .125" (3,2 mm)

.875	22,2	1/2	3997	KOS 1/2	1.02	25,8		
1.093	27,8	3/4	3998	KOS 3/4	1.22	31,0	.45	11,5
1.375	34,9	1	3999	KOS 1	1.50	38,1		
1.750	44,5	1-1/4	4000	KOS 1-1/4	1.91	48,4	.47	12,0
2.000	50,8	1-1/2	4001	KOS 1-1/2	2.16	54,9	.45	11,5

Multiple Locking Steps for Panel Thickness up to .250" (6,4 mm)

.875	22,2	1/2	3991	KOST 1/2	1.02	25,8		
1.093	27,8	3/4	3992	KOST 3/4	1.22	31,0	.56	14,3
1.375	34,9	1	3993	KOST 1	1.50	38,1		
1.750	44,5	1-1/4	3994	KOST 1-1/4	1.91	48,4		
2.000	50,8	1-1/2	3995	KOST 1-1/2	2.16	54,9	.58	14,7
2.500	63,5	2	4002	KOS 2	2.73	69,3	.75	19,1

Standard color silver gray.

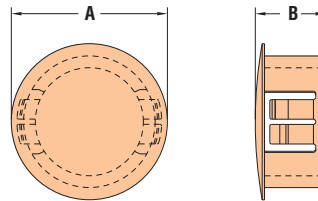

Heyco® Nylon V-0 Knock Out Seals

Multiple Locking Steps for Panel Thickness up to .13" (3,2 mm)
Mounting Hole Diameter Range: 1/2" to 1-1/2" Electrical Knock-outs (.875" to 2.000" nominal)

- **Molded from a nylon material which, in the event of a fire, will not burn and will not produce toxic gases.** Also formulated for sunlight resistance.

MOUNTING HOLE DIAMETER		TRADE SIZE	PART NO. Black	DESCRIPTION	PART DIMENSIONS			
in.	mm.				A Head Diameter		B Overall Height	
					in.	mm.	in.	mm.

Standard color black.

Material	Nylon 6/6
Certifications	Recognized under the Component Program of Underwriters' Laboratories, File E51579 Certified by Canadian Standards Association, File 8919
Flammability Rating	KOS: 94V-2, HFP 94V-0
Temperature Range	-40°F (-40°C) to 221°F (105°C)

Quick Specs

“Stay Connected” with



Bushings, Grommets, HEYcaps & Plugs

a PennEngineering® Company



Heyco® V-0 Liquid Tight Hole Plugs Standard 85 Durometer Plugs

Maximum Panel Thickness .125" (3,2 mm)

Mounting Hole Diameter Range: .500" (12,7 mm) to 1.375" (34,9 mm)

MOUNTING HOLE DIAMETER		PART NO.	DESCRIPTION	UL or RUL	PART DIMENSIONS					
in.	mm.				A Head Diameter		B Overall Height		C Head Thickness	
.500	12,7	3830	KOS LT 500	RUL	.91	23,1	.45	11,4	.29	7,4
.625	15,9	3834	KOS LT 625	RUL	1.03	26,2	.47	11,9	.31	7,9
.750	19,1	3831	KOS LT 750	RUL	1.15	29,2	.51	13,0	.35	8,9
.875	22,2	3833	KOS LT 1/2	UL	1.23	32,5	.50	13,5	.36	9,1
1.000	25,4	3832	KOS LT 1000	RUL	1.41	35,8	.56	14,2	.40	10,2
1.093	27,8	3835	KOS LT 3/4	UL	1.53	38,6	.55	14,0	.40	10,2
1.375	34,9	3837	KOS LT 1	UL	1.78	45,2	.57	14,5	.42	10,7

Available in black only.

- Oil tight, rain tight, submersible.
- UL certified for outdoor applications.
- V0 Flammability rating.
- Install with fingertip pressure (no tool required).
- Multiple nominal sizes fit .500" (12,7 mm) to 1.000" (25,4 mm) true size mounting holes.
- Three trade sizes fit 1/2" to 1" knock-out holes.
- Lock firmly in boxes from .030" (0,8 mm) to .125" (3,2 mm) thick.
- True sizes are UL recognized under Underwriters' Laboratories File E51579 and CSA certified by Canadian Standard Association File 8919.
- Trade sizes are UL listed under Underwriters' Laboratories File E51579 and CSA certified by Canadian Standard Association File 081067C. **Now certified for NEMA 4 and 4X applications.**

Low 75 Durometer Plugs

Maximum Panel Thickness .125" (3,2 mm)

Mounting Hole Diameter Range: .875" (22,2 mm) to 1.375" (34,9 mm)

MOUNTING HOLE DIAMETER*		PART NO.		DESCRIPTION	UL or RUL	PART DIMENSIONS*					
in.	mm.	Black	Gray			A Head Diameter		B Overall Height		C Head Thickness	
.875	22,2	3833FN	3833FP	KOS LT 1/2 LD	UL	1.23	32,5	.53	13,5	.36	9,1
1.093	27,8	3835FN	3835FP	KOS LT 3/4 LD	UL	1.53	38,6	.55	14,0	.40	10,2
1.375	34,9	3837FN	3837FP	KOS LT 1 LD	UL	1.80	45,2	.56	14,3	.42	10,7

Standard colors black and gray.

*Consult Heyco for other Liquid Tight Hole Plug sizes in Low Durometer material.

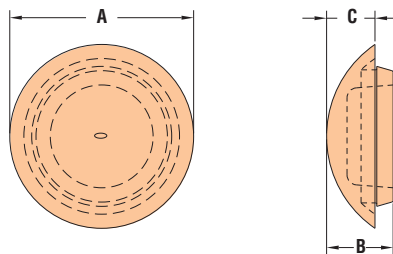

Material	85 Durometer 75 Durometer	TPE-Hardness 85 Shore A TPE-Hardness 75 Shore A
Certifications	Trade Sizes (1/2, 3/4, 1)	UL Listed under Underwriters' Laboratories File E51579 CSA Certified by Canadian Standard Association File 081067C
	True Sizes (all others)	RUL Recognized under Underwriters' Laboratories File E51579 CSA Certified by Canadian Standard Association File 8919
Flammability Rating		94V-0
Temperature Range		-81°F (-60°C) to 275°F (135°C)

Quick Specs

“Stay Connected” with



Bushings, Grommets, HEYcaps & Plugs

a PennEngineering® Company



Heyco® Nylon Liquid Tight Threaded Plugs

Liquid Tight, with Integral Sealing Ring
Hex Head with Slot

**NO O-RING
REQUIRED!**

- **Integral sealing ring** ensures a superior seal at mounting hole location, every time.
- IP 68 Rated.
- Provide a liquid-tight seal up to 70 psi.
- UL Rated for Type NEMA 3R, 4 and 4X applications.
- Threaded plugs for hydraulic and pneumatic applications.
- Seal threaded openings and protect against contamination and moisture.
- Lower cost option over brass or steel plugs.
- Non-corrosive—resist salt water, weak acids, gasoline, alcohol, oil, grease, and common solvents.
- Resist oil and heat up to 221°F (105°C).
- Approximate Head Thickness: .21" (5,3 mm). Thickness may vary.
- Hex shaped head with slot for wrench or screwdriver installation.
- Electrically non-conductive Nylon 6/6.

THREAD TYPE/SIZE	PART NO.			DESCRIPTION	PART DIMENSIONS			
	Black	Gray	V-0 Black NEW		A Wrenching Flats		B Overall Length	
					in.	mm.	in.	mm.

NPT

NPT 1/4	3544B	3544	-	LTTT NPT 1/4	.63	16,0	.66	16,8
NPT 3/8	3545B	3545	-	LTTT NPT 3/8	.83	21,1	.69	17,5
NPT 1/2	3546B	3546	V3546*	LTTT NPT 1/2	.98	24,9	.81	20,6
NPT 3/4	3547B	3547	V3547*	LTTT NPT 3/4	1.29	32,8	.86	21,8
NPT 1*	3548B	3548	V3548	LTTT NPT 1	1.74	44,2	1.05	26,7
NPT 1-1/4*	3549B	3549	V3549	LTTT NPT 1-1/4	2.06	52,3	1.08	27,4

PG - for PG Thread Specifications, see page 3-49

PG 7	3574B	3574	-	LTTT PG 7	.63	16,0	.53	13,5
PG 9	3575B	3575	-	LTTT PG 9	.83	21,0		
PG 13.5	3576B	3576	-	LTTT PG 13.5	.98	24,9	.62	15,8
PG 21	3401B	3401	-	LTTT PG 21	1.29	32,8	.68	17,3
PG 29*	3578B	3578	-	LTTT PG 29	1.74	44,2	.87	22,1
PG 36*	3579B	3579	-	LTTT PG 36	2.06	52,3	.78	19,8

Metric

M12	3582B	3582	-	LTTT M12	.63	16,0	.53	13,5
M16	3583B	3583	-	LTTT M16	.83	21,1		
M20	3584B	3584	-	LTTT M20	.98	24,9	.62	15,8
M32*	3586B	3586	-	LTTT M32	1.74	44,2	.87	22,1
M40*	3587B	3587	-	LTTT M40	2.06	52,3	.78	19,8

Standard colors black and gray. Consult Heyco for other colors, and sizes in V-0 material.
*Not cURus.

NEW

Available in Small Packs

PART NO.	DESCRIPTION	QTY
3546-P	LTTT NTP 1/2 Gray 100PK	100
3547-P	LTTT NTP 3/4 Gray 100PK	100
3548-P	LTTT NTP 1 Gray 100PK	100
3549-P	LTTT NTP 1-1/4 Gray 50PK	50

Standard color gray.

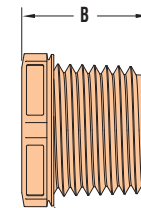
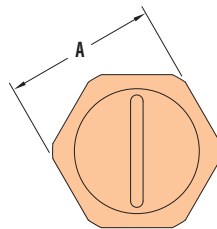

INTEGRAL SEALING RING

*Quick
Specs*

Material	Nylon 6/6
Certifications	cULus Recognized under the Component Program of Underwriters' Laboratories, File E330194 to both Canadian and U.S. Requirements
Flammability Rating	94V-2
Temperature Range	-40°F (-40°C) to 221°F (105°C)
IP Rating	IP 68 (70 PSI, 5 BAR)

“Stay Connected” with



Bushings, Grommets, HEYcaps & Plugs

a PennEngineering® Company



HEYCo-molded™ Liquid Tight Break-Thru Plugs

Mounting Hole Diameter Range: .500" (12,7 mm) to 1.500" (38,1 mm)

Small Packs Available

PANEL DIMENSIONS				CABLE DIAMETER RANGE		PART NO. Black	PACKAGING		DESCRIPTION	PART DIMENSIONS			
Thickness at Locking Finger Steps		Mounting Hole Diameter*		in.	mm.		BULK (Std)	SMALL PACK**		A Head Diameter		B Overall Height	
in.	mm.	in.	mm.	in.	mm.			in.	mm.	in.	mm.		
With Five Locking Finger Steps for Panels up to .063" (1,6 mm) Thick													
.020	0,5	.500	12,7	.080 - .200	2,0 - 5,1	C2008	1000	10	LTBP 500-063	.92	23,4		
.032	0,8	.625	15,9	.130 - .375	3,3 - 9,5	C2012	1000	10	LTBP 625-063	1.03	26,2		
.040	1,0	.750	19,1	.175 - .400	4,4 - 10,2	C2016	1000	10	LTBP 750-063	1.15	29,2	.32	8,1
.048	1,2	.875	22,2	.130 - .450	3,3 - 11,4	C2020	1000	10	LTBP 875-063	1.28	32,5		
.063	1,6	1.000	25,4	.200 - .715	5,1 - 18,2	C2022	1000	10	LTBP 1000-063	1.43	36,3		
		1.093	27,8	.250 - .765	6,4 - 19,4	C2024	1000	10	LTBP 1093-063	1.53	38,9		
With Seven Locking Finger Steps for Panels from .063" (1,6 mm) to .250" (6,4 mm) Thick													
.063	1,6	.500	12,7	.080 - .200	2,0 - 5,1	C2058	1000	10	LTBP 500-250	.92	23,4		
.080	2,0	.625	15,9	.130 - .375	3,3 - 9,5	C2062	1000	10	LTBP 625-250	1.03	26,2		
.094	2,4	.750	19,1	.175 - .400	4,4 - 10,2	C2066	1000	10	LTBP 750-250	1.15	29,2	.63	15,9
.125	3,2	.875	22,2	.130 - .450	3,3 - 11,4	C2070	1000	10	LTBP 875-250	1.28	32,5		
.157	4,0	1.000	25,4	.200 - .715	5,1 - 18,2	C2072	1000	10	LTBP 1000-250	1.43	36,3		
.200	5,1	1.093	27,8	.250 - .765	6,4 - 19,4	C2074	1000	10	LTBP 1093-250	1.53	38,9		
.250	6,4	1.375	34,9	.300 - .950	7,6 - 24,1	C2080	1000	10	LTBP 1375-250	1.80	45,7	.67	17,0
		1.500	38,1	.375 - 1.060	9,5 - 26,9	C2082	1000	10	LTBP 1500-250	1.93	49,0		

Standard color black. Consult Heyco for other colors.

*Consult Heyco for other Mounting Hole Diameters. Our Axcell Rapid Response Team is ready to meet your requirements.

**To order Small Packs, please add the suffix -P to Part No., e.g., C2008-P

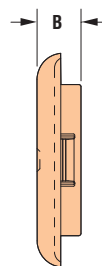
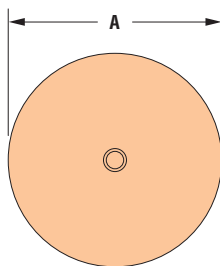

- These **co-molded** nylon and elastomer parts function as **Liquid Tight Plugs** with an IP 67/68 rating, yet can be pierced by **round wire, cable or tubing** to function as **Liquid Tight Bushings** with the same resulting IP 67/68 rating.
- **Certified by UL under UL 635**
- For use in panels as thin as .020" (0,5 mm) and as thick as .250" (6,4 mm).
- Provide liquid tight closure when used as a plug. When pierced, function as a liquid tight bushing that convert raw edged holes to smooth, neat, insulated holes.
- Used as a liquid tight bushing, HEYCO-molded Liquid Tight Break-Thru Plugs insulate and mechanically protect electrical and telecommunications cable, tubing, hose, rope, and utility lines.
- Locking fingers snap into holes with fingertip pressure.
- Locking fingers in fractional increments up to the maximum panel thickness.
- Withstand a push back force of greater than 35 pounds.
- Available in multiple sizes for use in .500" (12,7 mm) to 1.500" (38,1 mm) diameter holes.

Materials	Nylon 6/6 and TPE
Certifications	Recognized under the Component Program of Underwriters' Laboratories File E15331
Flammability Rating	HB
Temperature Range	-40°F (-40°C) to 212°F (100°C)
IP Rating	67/68



HEYCap™ D-Subminiature Protection Caps

- DSC Series Caps are designed to provide **electrostatic discharge protection** for rectangular D-subminiature input/output type connectors.
- Designed with an **integral flange** for easy application and removal.
- Fit over both **Standard Density** and **High Density** D-Sub Shells.
- Molded in pink dissipative ethylene vinyl acetate, which **meets the static decay requirements** of MIL-PRF-81705D: Surface resistivity less than 1×10^{12} ohms/sq.
- For similar schematic drawings see D-Subminiature Mounting Hole Plugs, see page 6-42.

	Shell Designation & Type	SHELL DIMENSIONS				PART NO. Pink*	DESCRIPTION	PART DIMENSIONS							
		A Width		B Length				C Head		D		E Body		F	
		in.	mm.	in.	mm.			in.	mm.	in.	mm.	in.	mm.	in.	mm.
1 or E	9 Socket	.31	7,9	.64	16,3	G5160	DSC 1S	.79	20,1	.45	11,4	.72	18,2	.38	9,5
	9 Pin	.33	8,4	.67	16,9	G5161	DSC 1P	.86	21,8	.51	12,9	.78	19,8	.43	10,9
2 or A	15 Socket	.31	7,9	.97	24,6	G5162	DSC 2S	1.10	27,9	.45	11,4	1.04	26,4	.38	9,5
	15 Pin	.33	8,4	.99	25,2	G5163	DSC 2P	1.19	30,2	.51	12,9	1.12	28,3	.43	10,9
3 or B	25 Socket	.33	7,9	1.51	38,3	G5164	DSC 3S	1.66	42,2	.46	11,7	1.12	28,3	.37	9,4
	25 Pin	.31	8,4	1.53	40,0	G5165	DSC 3P	1.70	43,2	.52	13,2	1.58	40,2	.43	11,0
4 or C	37 Socket	.31	7,9	2.16	54,8	G5166	DSC 4S	2.29	58,2	.45	11,4	1.61	41,0	.37	9,3
	37 Pin	.33	8,4	2.18	55,4	G5167	DSC 4P	2.37	60,2	.52	13,2	1.23	30,5	.45	11,4
5 or D	50 Socket	.42	10,7	2.06	52,4	G5168	DSC 5S	2.21	56,1	.56	14,2	2.15	54,5	.49	12,3
	50 Pin	.44	11,1	2.08	52,8	G5169	DSC 5P	2.27	57,6	.62	15,7	2.20	55,8	.55	14,0
6	104 Socket	.49	12,3	2.19	55,6	G5170	DSC 6S	2.35	59,7	.65	16,5	2.27	57,6	.56	14,3
	104 Pin	.50	12,8	2.21	56,2	G5171	DSC 6P	2.44	62,0	.70	17,8	2.29	58,2	.58	14,8

* Material: Pink Static Dissipative Ethylene Vinyl Acetate (EVA). Black Conductive Polyethylene Copolymer also available, please consult Heyco.



HEYCap™ Electro Miniature Protection Caps

- EMC Series Caps fit 36- and 68-pin Champ 050 series connectors and 50-pin Champ-type connectors.
- Designed with an **integral flange** for easy application and removal.
- Molded in pink dissipative ethylene vinyl acetate, which **meets the static decay requirements** of MIL-PRF-81705D: Surface resistivity less than 1×10^{12} ohms/sq.
- For similar schematic drawings see D-Subminiature Mounting Hole Plugs, see page 6-42.

	Typical Configuration	SHELL DIMENSIONS				PART NO. Pink*	DESCRIPTION	PART DIMENSIONS							
		A Width		B Length				C Head		D		E Body		F	
		in.	mm.	in.	mm.			in.	mm.	in.	mm.	in.	mm.	in.	mm.
	36 Pin	.25	6,4	1.05	26,7	G5172	EMC 36	1.18	30,0	.40	10,2	1.11	27,9	.31	7,9
	50 Pin	.48	12,1	2.51	63,5	G5173	EMC 50	2.63	66,8	.60	15,2	2.57	65,1	.54	13,6
	68 Pin	.26	6,6	1.83	46,5	G5174	EMC 68	1.95	49,5	.38	9,6	1.89	48,0	.32	8,1

* Material: Pink Static Dissipative Ethylene Vinyl Acetate (EVA). Black Conductive Polyethylene Copolymer also available, please consult Heyco.

Quick Specs

Material
Temperature Range

Pink Static Dissipative Ethylene Vinyl Acetate (EVA)
-98°F (-68°C) to 140°F (60°C)

“Stay Connected” with



Bushings, Grommets, HEYcaps & Plugs

a PennEngineering® Company

Heyco® Nylon D-Subminiature Mounting Hole Plugs

Clearance Fit for Panel Thickness up to .170" (4,3 mm)

MOUNTING HOLE SIZE				PART NO.	DESCRIPTION	PART DIMENSIONS							
A		B				C		D		E		F	
in.	mm.	in.	mm.	Black	in.	mm.	in.	mm.	in.	mm.	in.	mm.	
.45	11,4	.81	20,6	2966	POP-DB9	1.25	31,8	.70	17,8	.69	17,5	.41	10,4
		1.13	28,8	2968	POP-DB15	1.57	39,8	.70	17,8	1.05	26,7		
		1.67	42,5	2970	POP-DB25	2.12	51,0	.70	17,8	1.55	39,4		
		2.32	59,1	2972	POP-DB37	2.77	70,4	.70	17,8	2.23	56,6		

Standard color black. Consult Heyco for other colors.

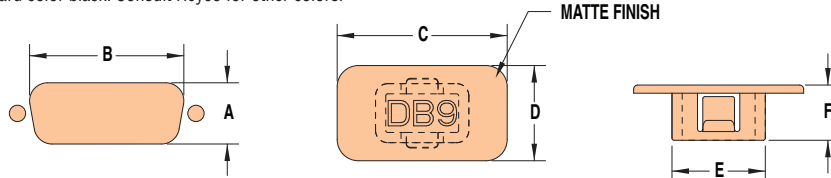

Material	Nylon 6/6
Certifications	Recognized under the Component Program of Underwriters' Laboratories, File E51579 Certified by Canadian Standards Association, File 8919
Flammability Rating	94V-2
Temperature Range	-40°F (-40°C) to 221°F (105°C)

Custom Color Match and Special Engraved Identification Available. Consult Heyco for Details

Quick Specs



Heyco® IEC-14 Plug

For IEC-13 Female Connectors

PART NO.	DESCRIPTION	PART DIMENSIONS					
		A		B		C	
Black		in.	mm.	in.	mm.	in.	mm.
G5365	IECP C14	.96	24,4	.66	16,8	.38	9,7

Standard color black.

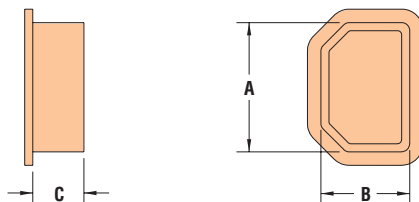

- These non-conductive plugs are used to **protect female IEC-13 connectors** during transit and storage.
- Will keep your connector **free of dust, moisture, and contaminants**.
- The flanged Plug head provides **ease of installation and removal**.
- Consult Heyco for the **IEC-20 Plug** (for IEC-19 female connectors).

Material	LDPE
Temperature Range	-94°F (-70°C) to 150°F (66°C)

Quick Specs



USB-A Cap

- Silicone material for high temperature applications up to 302°F (150°C).
- Protects adapter’s internal components with stress-free installation.

USB-B Cap

- Non-conductive, inexpensive, protects USB-B ports.
- Shields female ports from dust, moisture, and contaminants.
- USB-B plugs have a convenient pull-tab for quick and easy removal.
- Applicable Specs: USB-B MS-90376-Y, MS-25177, NAS-820, NAS-837

Heyco® Connector Caps and Plugs

PART NO. Black	DESCRIPTION	PART DIMENSIONS					
		A		B		C	
		in.	mm.	in.	mm.	in.	mm.
USB Series							
2960	USB-A Cap*	.48	12,2	.18	4,6	.44	11,1
2962	USB-B Plug	.36	9,0	.25	6,4	.25	6,4
CP-RJ Series							
2967	CP-RJ11	.41	10,4	.41	10,4	.33	8,4
2969	CP-RJ45	.49	12,4				

*USB-A Cap color is red.

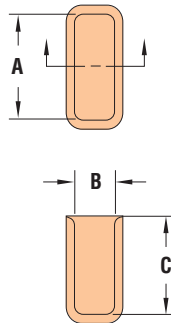

USB-A

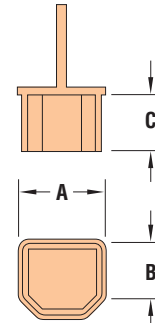

USB-B

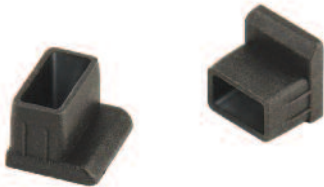

CP-RJ Plugs

- Silicone material for high temperature applications up to 302° F (150° C).
- Protects adapter’s internal components with stress-free installation.
- For Heyco Connector Port Plugs, **Part Nos. 3388 and 3389**, see page 6-34.

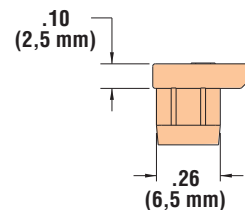
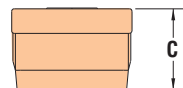
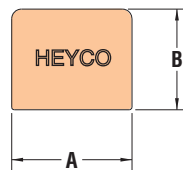

CP-RJ

Quick Specs

	USB-A	USB-B	CP-RJxx
Material	Vinyl	LDPE	Silicone Rubber
Fammability Rate	HB	HB	HB
Temperature Range	-26°F (-32°C) to 200°F (93°C)	0°F (-18°C) to 175°F (79°C)	-26°F (-32°C) to 400°F (204°C)

“Stay Connected” with



Bushings, Grommets, HEYcaps & Plugs

a PennEngineering® Company

Heyco® PG and Metric Threaded Plugs

Round Head with Slot

Plastic

THREAD TYPE/SIZE	PART NO.		DESCRIPTION	PART DIMENSIONS			
	Gray	Black		A Head Diameter		B Overall Height	
				in.	mm.	in.	mm.
PG Threads - Polystyrene							
PG 7	3405	3405B	TP PG 7	.59	15,0	.32	8,0
PG 9	3407	3407B	TP PG 9	.75	19,0	.37	9,5
PG 11	3402	3402B	TP PG 11	.87	22,0		
PG 13	3412	3412B	TP PG 13	.98	25,0	.39	10,0
PG 16	3414	3414B	TP PG 16	1.06	27,0		
PG 21	3416	3416B	TP PG 21	1.30	33,0		
PG 29	3418	3418B	TP PG 29	1.73	44,0	.47	12,0
PG 36	3415	3415B	TP PG 36	2.17	55,0	.55	14,0
NEW! PG 42	3400	3400B	TP PG 42	2.44	62,0		
PG 48	3417	3417B	TP PG 48	2.72	69,0	.63	16,0

Metric Threads - Nylon

M12 x 1,5	3403	3403B	TP M12	.59	15,0		
M16 x 1,5	3404	3404B	TP M16	.79	20,0	.41	10,5
M20 x 1,5	3406	3406B	TP M20	.95	24,0		
M25 x 1,5	3408	3408B	TP M25	1.18	30,0	.51	13,0
M32 x 1,5	3409	3409B	TP M32	1.48	37,0	.53	13,5
M40 x 1,5	3410	3410B	TP M40	1.81	46,0	.55	14,0
M50 x 1,5	3411	3411B	TP M50	2.20	56,0	.63	16,0
M63 x 1,5	3413	3413B	TP M63	2.76	70,0	.71	18,0

Standard color gray and black. Consult Heyco for other colors.

Nickel-Plated Brass

ALL NEW PRODUCTS!

THREAD TYPE/SIZE	PART NO.	DESCRIPTION	PART DIMENSIONS			
			A Head Diameter		B Overall Height	
			in.	mm.	in.	mm.
PG Threads						
PG 7	13405	BRASS TP PG 7	.55	14,0	.31	8,0
PG 9	13407	BRASS TP PG 9	.67	17,0	.35	9,0
PG 11	13402	BRASS TP PG 11	.79	20,0		
PG 13	13412	BRASS TP PG 13	.87	22,0		
PG 16	13414	BRASS TP PG 16	.94	24,0	.37	9,5
PG 21	13416	BRASS TP PG 21	1.18	30,0	.43	11,0
PG 29	13418	BRASS TP PG 29	1.54	39,0	.47	12,0
PG 36	13415	BRASS TP PG 36	1.97	50,0	.59	15,0
PG 42	13400	BRASS TP PG 42	2.36	60,0		
PG 48	13417	BRASS TP PG 48	2.56	65,0	.63	16,0
Metric Threads						
M6 x1.0	13397	BRASS TP M6*	.35	9,0		
M8 x1.25	13398	BRASS TP M8*	.39	10,0		
M10 x1.5	13399	BRASS TP M10*	.47	12,0	.31	8,0
M12 x 1,5	13403	BRASS TP M12	.55	14,0		
M16 x 1,5	13404	BRASS TP M16	.75	19,0		
M20 x 1,5	13406	BRASS TP M20	.94	24,0	.35	9,0
M25 x 1,5	13408	BRASS TP M25	1.10	28,0	.43	11,0
M32 x 1,5	13409	BRASS TP M32	1.38	35,0	.47	12,0
M40 x 1,5	13410	BRASS TP M40	1.77	45,0	.55	14,0
M50 x 1,5	13411	BRASS TP M50	2.17	55,0	.59	15,0
M63 x 1,5	13413	BRASS TP M63	2.76	70,0	.63	16,0

Metric Threads

* Metric course-pitch threads

	Plastic TP Plugs	Brass TP Plugs
Material	Nylon 6/6 or Impact Resistant Polystyrene	Nickel-Plated Brass with an NBR O-ring
Flammability Rating	94V-2	
Temperature Range	-4° F (-20° C) to 176° F (80° C)	-40° F (-40° C) to 212° F (100° C)
IP Rating	IP 50	IP 68



- Used to close unneeded PG and Metric threaded holes when other threaded accessories may be added at a later time.
- Designed with slot for screwdriver installation
- For PG Threaded specifications, see page 3-57
- For Heyco Snap-In Metric Dome Plugs, see page 6-30.
- Nickel-Plated Brass Plugs are ideal where extra durability and strength are needed such as harsh environmental conditions.
- Nickel-Plated Brass Plugs include NBR O-ring

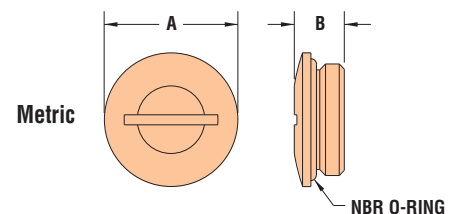
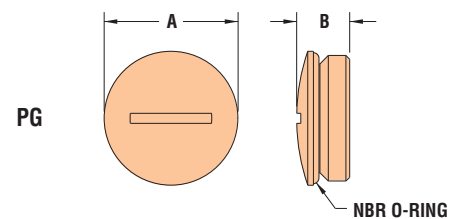
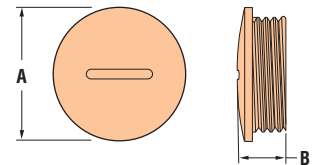

Quick Specs

“Stay Connected” with



Bushings, Grommets, HEYcaps & Plugs

a PennEngineering® Company



Heyco® Plugs for Threaded Ports

For NPT/NPS Threaded Ports

- Provide a positive seal on threaded ports.
- Flange (if applicable) compresses against the mounting hole surface area, keeping contaminants from the spot face.
- **For NPT:** Square Head; Part Nos. G5404 and G5405 have integral Shoulder Washer.
- **For NPS:** Round, 12 point “socket pattern” Head with integral, serrated Shoulder Washer.
- Applicable Specs. MIL-C-52078, MIL-C-5501/5, NAS 840.
- Red color.

THREADED PORT	PART NO.	DESCRIPTION	PART DIMENSIONS							
			A Square or 12-Point Socket Head*		B Depth		C Head Height		D Shoulder Diameter	
			in.	mm.	in.	mm.	in.	mm.	in.	mm.
For NPT Threaded Ports - Square Head - Red Color										
ALL NEW PRODUCTS										
1/8	G5400	PNPT 1/8	.28	.44	11,2	.25	6,4			
1/4	G5401	PNPT 1/4	.37	.48	12,2	.25	6,4	n/a	n/a	
3/8	G5402	PNPT 3/8	.44	.56	14,2	.25	6,4			
1/2	G5403	PNPT 1/2	.56	.59	15,0	.25	6,4			
3/4	G5404	PNPS 3/4-S **	.62	.62	15,7	.25	6,4	1.11	28,3	
1	G5405	PNPS 1-S **	.81	.72	18,3	.31	7,9	1.40	35,6	
1-1/4	G5406	PNPT 1-1/4	1.00	.75	19,1	.35	8,9			
1-1/2	G5407	PNPT 1-1/2	1.25	.94	23,9	.38	9,7			

For NPS Threaded Ports - 12 Point Head - Red Color

1/8	G5410	PNPS 1/8	9/16	.27	6,9	.31	7,9	.56	14,2	
1/4	G5411	PNPS 1/4	9/16	.37	9,4	.31	7,9	.74	18,8	
3/8	G5412	PNPS 3/8	9/16	.33	8,4	.38	9,7	.83	21,1	
1/2	G5413	PNPS 1/2	9/16	.55	14,0	.37	9,4	1.04	26,4	
3/4	G5414	PNPS 3/4	9/16	.63	16,0	.41	10,4	1.31	33,3	

For SAE Threaded Ports - 12 Point Head - Red Color - with Integral Sealing Ring*

7/16-24	G5420	PSAE 7/16-24	3/8	.34	8,6	.26	6,6	.66	16,8	
7/16-20	G5421	PSAE 7/16-20	3/8	.34	8,6	.30	7,6	.73	18,5	
1/2-20	G5422	PSAE 1/2-20	7/16	.34	8,6	.30	7,6	.80	20,3	
9/16-18	G5423	PSAE 9/16-18	1/2	.36	9,1	.30	7,6	1.02	25,9	
3/4-16	G5424	PSAE 3/4-16	11/16	.41	10,4	.31	7,9	1.16	29,5	
7/8-14	G5425	PSAE 7/8-14	13/16	.53	13,5	.31	7,9	1.45	36,8	
1-1/16-12	G5426	PSAE 1-1/16-12	1	.61	15,5	.31	7,9	1.74	44,2	
1-5/16-12	G5427	PSAE 1-5/16-12	1-1/4	.61	15,5	.33	8,4	2.17	55,1	
1-5/8-12	G5428	PSAE 1-5/8-12	1-9/16	.61	15,5	.33	8,4	2.42	61,5	
1-7/8-12	G5429	PSAE 1-7/8-12	1-7/8	.62	15,7	.34	8,6			

For ISO Threaded Ports - Green Color - with Integral Sealing Ring

10 x 1.5	G5431	PISO 10	10	.33	8,4	.33	8,4	.65	16,5	
12 x 1.5	G5432	PISO 12	12	.41	10,4	.34	8,6	.73	18,5	
14 x 1.5	G5433	PISO 14	12	.41	10,4	.38	9,7	.81	20,6	
18 x 1.5	G5434	PISO 18	16	.41	10,4	.44	11,2	.97	24,6	
22 x 1.5	G5435	PISO 22	20	.41	10,4	.44	11,2	1.12	28,4	
27 x 2	G5436	PISO 27	24	.41	10,4	.44	11,2	1.36	34,5	

*SAE Threaded Ports feature a slotted 12 point Socket Head.

**NPS threaded hub with shoulder

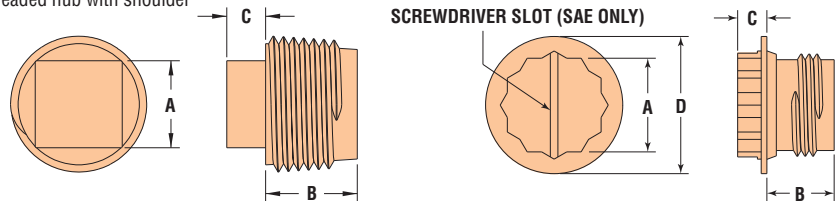

	PNPT, PNPS & PSAE	PISO
Material	HDPE	Polypropylene
Temperature Range	0°F (-18°C) to 165°F (74°C)	-90°F (-70°C) to 250°F (121°C)

Quick
Specs

“Stay Connected” with



Bushings, Grommets, HEYcaps & Plugs

a PennEngineering® Company



Heyco® Push-In Threaded Plugs - For SAE and NPT Threaded Ports

THREAD TYPE/SIZE		PART NO. Black No Tab	PART NO. Black With Tab	DESCRIPTION	PART DIMENSIONS					
SAE in.	NPT in.				A Head Diameter in. mm.		B Overall Height in. mm.		C Bottom Dia. in. mm.	
1/4	-	9680	-	TP PI-250	.40	10,2	.25	6,4	.21	5,3
5/16	-	9681	-	TP PI-312	.52	13,2	.24	6,1	.25	6,4
3/8	1/8	9682	9682T	TP PI-375	.59	15,0	.24	6,1	.32	8,1
7/16	-	9683	9683T	TP PI-437	.64	16,3	.27	6,9	.37	9,4
1/2	1/4	9684	9684T	TP PI-500	.72	18,3	.27	6,9	.44	11,2
9/16	-	9685	-	TP PI-562	.81	20,6	.29	7,4	.50	12,7
5/8	3/8	9686	9686T	TP PI-625	.96	24,4	.29	7,4	.56	14,2
3/4	-	9687	9687T	TP PI-750	.95	24,1	.29	7,4	.68	17,3
7/8	-	9688	9688T	TP PI-875	1.15	29,2	.29	7,4	.80	20,3

Standard color black.

- Offer the convenience of a push-in plug with the plugging quality of a threaded plug.
- Available with or without convenient Pull Tab for easy removal.

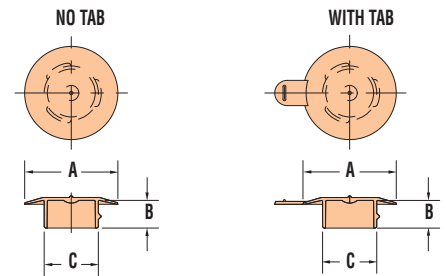

Heyco® TEMPlugs™ - For NPT Threaded Ports

Temporary Threaded Plugs for In-House Pressure Testing, Handling, and Transport

NPT THREADED PORT SIZE	PART NO. Black	DESCRIPTION	PART DIMENSIONS							
			A Wrenching Flats in. mm.		B Threaded Section in. mm.		C Head Height in. mm.		D Flange Diameter in. mm.	

Square Head - with Flange

1/8	G5440	PTNS 1/8-F	.43	10,9	.29	7,4	.19	4,8	.56	14,2
1/4	G5441	PTNS 1/4-F	.44	11,2	.35	9,0	.25	6,4	.69	17,5
3/8	G5442	PTNS 3/8-F	.44	11,2	.41	10,4	.25	6,4	.81	20,6
1/2	G5443	PTNS 1/2-F	.56	14,2	.47	11,9	.25	6,4	1.00	25,4
3/4	G5444	PTNS 3/4-F	.63	16,0	.52	13,2	.25	6,4	1.25	31,8

Square Head - no Flange

3/4	G5449	PTNS 3/4	.62	15,7	.52	13,2	.25	6,4	n/a	n/a
1	G5450	PTNS 1	.81	20,6	.59	15,0	.25	6,4	n/a	n/a
1-1/4	G5451	PTNS 1-1/4	1.00	25,4	.83	21,1	.38	9,7	n/a	n/a
1-1/2	G5452	PTNS 1-1/2	1.25	31,8						

Hex Head

1/4	G5455	PTNH 1/4	.25	6,4	.31	7,9				
3/8	G5456	PTNH 3/8	.31	7,9	.38	9,7				
1/2	G5457	PTNH 1/2	.38	9,7						
3/4	G5458	PTNH 3/4	.56	14,2	.50	12,7				
1	G5459	PTNH 1	.63	16,0	.53	13,5				

Standard color black.

Material	EVA Ethylene Vinyl Acetate (part nos. 9680 & 9681) LDPE Low Density Polyethylene (part nos. 9682 thru 9688T) HDPE High-Density Polyethylene (TEMPlugs)
Temperature Range	EVA -98°F (-68°C) to 140°F (60°C) LDPE -94°F (-70°C) to 150°F (66°C) HDPE 0°F (-18°C) to 165°F (74°C)



- Not intended for permanent applications; commonly used for low-pressure testing and in-plant processing.
- Keep contaminants and moisture from threaded ports.
- Oil and heat resistant up to 250°F.
- Applicable Spec: MIL-C-5501/5, NAS 840.

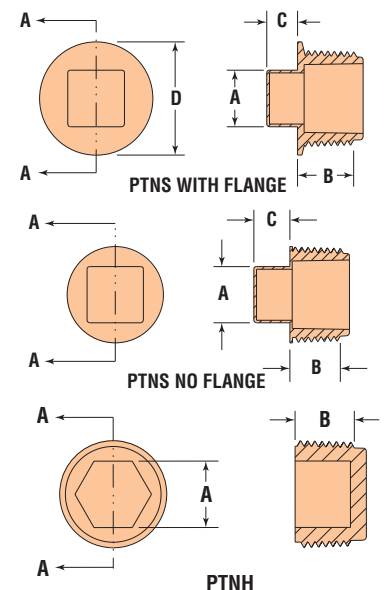



HEYCap™ Tapered Caps and Plugs–NPT

For NPT Fitting Hubs and Threaded Mounting Holes

- HEYCaps can be used as either **caps or plugs**.
- Because they are tapered in design and made from highly flexible polyethylene, they not only **fit snugly** but are readily **removable**.
- Applicable Specs: MIL-C-5501/7 (MIL-C-52078), NAS-835.

CAPS:

- Especially recommended for use on **threaded external NPT fitting hubs**.
- Part dimensions are based on average threaded hub fit. Before ordering in quantity, please sample HEYCaps.
- Recommended Closures: Threaded hubs where Cap dimension B is at least 1% smaller than the hub to be capped. Minimum .020" (0,5 mm).

PLUGS:

- Especially recommended for use on **threaded internal NPT fittings and mounting holes**.
- Part dimensions are based on average tapped hole fit. Before ordering in quantity, please sample HEYCap Tapered Plugs.
- Recommended Closures: Threaded mounting holes where Plug dimension A is at least 1% larger than the hole to be plugged. Minimum .020" (0,5 mm).

Fits this NPT Hub or Mounting Hole	PART NO. Red	DESCRIPTION	PART DIMENSIONS							
			A - Major Body Diameters		B - Minor		C Head Diameter		D Depth	
			in.	mm.	in.	mm.	in.	mm.	in.	mm.

HEYCap Tapered Caps* for NPT Fitting Hubs - Body Diameters reference Inside

1/8	G5014	TCP 49-42†	.42	10,7	.36	9,0	.63	16,0	.38	9,7
1/4	G5020	TCP 61-55	.55	13,8	.47	11,9	.75	19,1	.44	11,2
3/8	G5027	TCP 76-69	.69	17,6	.61	15,6	.88	22,4	.50	12,7
1/2	G5035	TCP 91-85	.85	21,6	.74	18,8	1.06	26,9	.63	16,0
3/4	G5047	TCP 115-108	1.08	27,5	.93	23,7	1.31	33,3	.75	19,1
1	G5057	TCP 136-130	1.30	33,0	1.17	29,8	1.50	38,1	.81	20,6
1-1/4	G5071	TCP 168-162	1.62	41,1	1.50	38,0	1.88	47,8	.75	19,1
1-1/2	G5080	TCP 195-189	1.89	48,0	1.72	43,6	2.13	54,1		
2	G5096	TCP 246-240	2.40	61,0	2.24	56,8	2.63	66,8	1.00	25,4
2-1/2	G5110	TCP 299-295	2.95	74,9	2.69	68,2	3.13	79,5		
3	G5116	TCP 356-349	3.49	88,7	3.20	81,3	3.69	93,7	1.13	28,7

HEYCap Tapered Plugs** for NPT Threaded Mounting Holes - Body Diameters reference Outside

1/8	G5011	TCP 40-33	.40	10,1	.33	8,4	.53	13,5	.38	9,7
1/4	G5014	TCP 49-42†	.49	12,4	.42	10,7	.63	16,0		
3/8	G5022	TCP 63-57	.63	16,0	.55	14,0	.75	19,1	.47	11,9
1/2	G5029	TCP 79-73	.79	20,1	.69	17,5	.94	23,9	.56	14,2
3/4	G5040	TCP 104-98	1.04	26,4	.92	23,4	1.16	29,5	.69	17,5
1	G5048	TCP 122-115	1.22	31,0	1.09	27,7	1.41	35,8	.75	19,1
1-1/4	G5068	TCP 160-154	1.60	40,6	1.51	38,4	1.75	44,5	.50	12,7
1-1/2	G5075	TCP 181-175	1.81	46,0	1.78	45,2	2.00	50,8	.38	9,7
2	G5090	TCP 226-220	2.26	57,4	2.23	56,6	2.50	63,5	.50	12,7
2-1/2	G5106	TCP 279-273	2.79	70,9	2.64	67,1	2.94	74,7		
3	G5115	TCP 346-338	3.46	87,9	3.33	84,6	3.63	92,2	.75	19,1

*May also be used as Plugs: to determine Outside Diameters, add approximately .06" (1,5 mm) to Inside Diameter dimensions.

**May also be used as Caps: to determine Inside Diameters, subtract approximately .06" (1,5 mm) from Outside Diameter dimensions.

†Part No. **G5014** functions as a Cap for NPT 1/8" Hubs and a Plug for NPT 1/4" Hubs.

Standard color red.



TAPERED CAP

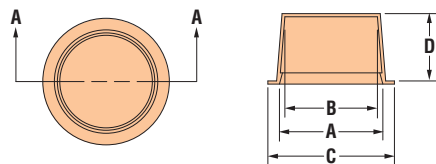

TAPERED PLUG

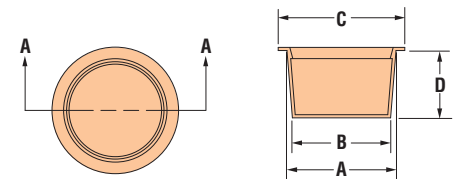

Quick Specs

Material	LDPE
Temperature Range	Standard Color: Red -94°F (-70°C) to 150°F (66°C)



HEYCap™ Tapered Caps and Plugs–SAE

For SAE Fitting Hubs and Threaded Mounting Holes

Fits this SAE Hub or Mounting Hole	PART NO. Red	DESCRIPTION	PART DIMENSIONS							
			A - Major Body Diameters		B - Minor Body Diameters		C Head Diameter		D Depth	
			in.	mm.	in.	mm.	in.	mm.	in.	mm.

HEYCap Tapered Caps* for SAE Fitting Hubs - Body Diameters reference Inside

1/8	G5009	TCP 37-30†	.30	7,7	.24	6,0	.50	12,7		
3/16	G5013	TCP 46-39	.39	10,0	.33	8,3	.59	15,0	.38	9,7
1/4	G5015	TCP 51-45	.45	11,5	.39	9,8	.66	16,8		
5/16	G5022	TCP 63-57	.57	14,4	.49	12,4	.75	19,1	.47	11,9
3/8	G5023	TCP 67-61	.61	15,4	.52	13,2	.81	20,6	.50	12,7
1/2	G5031	TCP 82-76	.76	19,3	.66	16,8	.97	24,6	.57	14,2
5/8	G5036	TCP 93-87	.87	22,0	.75	19,1	1.09	27,7	.63	16,0
3/4	G5047	TCP 115-108	1.08	27,5	.93	23,7	1.31	33,3	.75	19,1
1	G5057	TCP 136-130	1.30	33,0	1.17	29,8	1.50	38,1	.81	20,6
1-1/4	G5071	TCP 168-162	1.62	41,1	1.50	38,0	1.88	47,8	.75	19,1
1-1/2	G5080	TCP 195-189	1.89	48,0	1.72	43,6	2.13	54,1	1.00	25,4
1-3/4	G5092	TCP 231-225	2.25	57,2	2.07	52,7	2.56	65,0		
2	G5097	TCP 260-254	2.54	64,5	2.33	59,3	2.81	71,4	1.03	26,2

HEYCap Tapered Plugs** for SAE Threaded Mounting Holes - Body Diameters reference Outside

1/8	G5007	TCP 30-24	.30	7,7	.24	6,0	.44	11,2		
3/16	G5009	TCP 37-30†	.37	9,3	.30	7,6	.50	12,7		
1/4	G5012	TCP 43-37	.43	10,8	.36	9,2	.56	14,2	.38	9,7
5/16	G5014	TCP 49-42	.49	12,3	.42	10,6	.63	16,0		
3/8††	G5016	TCP 55-49	.55	13,9	.47	12,0	.69	17,5		
	G5020	TCP 61-55	.61	15,4	.53	13,5	.75	19,1	.44	11,2
1/2	G5026	TCP 73-66	.73	18,5	.64	16,3	.88	22,4	.50	12,7
5/8	G5033	TCP 85-79	.85	21,5	.75	19,1	1.00	25,9	.56	9,9
3/4	G5040	TCP 104-98	1.04	26,4	.92	23,2	1.16	29,5	.69	17,5
1	G5049	TCP 128-122	1.28	32,6	1.18	29,8	1.44	36,6	.63	16,0
1-1/4	G5068	TCP 160-154	1.60	40,6	1.51	38,4	1.75	44,5	.50	12,7
1-1/2	G5077	TCP 188-182	1.88	47,8	1.75	44,5	2.00	50,8	.75	19,1
1-3/4	G5089	TCP 224-218	2.24	57,0	2.07	52,5	2.44	62,0	1.00	25,4
2	G5096	TCP 246-240	2.46	62,6	2.30	58,4	2.63	66,8	1.00	25,4

*May also be used as Plugs: to determine Outside Diameters, add approximately .06" (1,5 mm) to Inside Diameter dimensions.

**May also be used as Caps: to determine Inside Diameters, subtract approximately .06" (1,5mm) from Outside Diameter dimensions.

†Part No. **G5009** functions as a Cap for SAE 1/8" Hubs and a Plug for SAE 3/16" Hubs.

††Use Part No. **G5016** for SAE 9/16-18 thread and Part No. **G5020** for SAE 5/8-18 thread Standard color red.

- HEYCaps can be used as either **caps or plugs**.
- Because they are tapered in design and made from highly flexible polyethylene, they not only **fit snugly** but are readily **removable**.
- Applicable Specs: MIL-C-5501/7 (MIL-C-52078), NAS-835.

CAPS:

- Especially recommended for use on **threaded external SAE and MIL Std.-type** tube and hydraulic fittings.
- Part dimensions are based on average threaded hub fit. Before ordering in quantity, please sample HEYCaps.
- Recommended Closures: Threaded hubs where Cap dimension B is at least 1% smaller than the hub to be capped. Minimum .020" (0,5 mm).

PLUGS:

- Especially recommended for use on **threaded internal SAE and MIL Std.-type** tube and hydraulic fittings.
- Part dimensions are based on average tapped hole fit. Before ordering in quantity, please sample HEYCap Tapered Plugs.
- Recommended Closures: Threaded mounting holes where Plug dimension A is at least 1% larger than the hole to be plugged. Minimum .020" (0,5 mm).
- See schematic on page 6-47.



Material	LDPE
Temperature Range	Standard Color: Red -94°F (-70°C) to 150°F (66°C)

Quick Specs

“Stay Connected” with



Bushings, Grommets, HEYcaps & Plugs

a PennEngineering® Company



- Close unneeded sheet metal panel holes in equipment such as automobile bodies, tanks, refrigeration units, etc.
- Recessed button head style (SMP R).
- Flush button head style (SMP F).
- Retaining bead snaps easily into place.
- For easier to install Sheet Metal Plugs made from flexible Santoprene, see Heyco Metric Ergonomic Plugs on page 6-33.

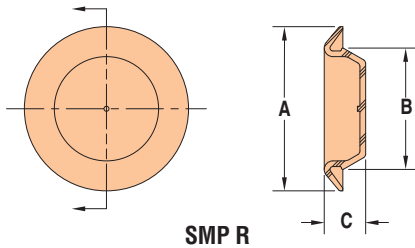

SMP R

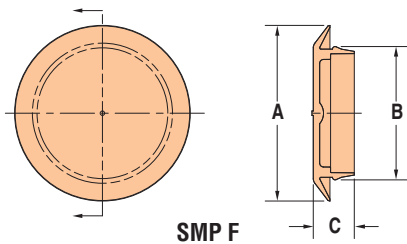

SMP F

Heyco® LDPE Sheet Metal Plugs

For Panel Thicknesses from .02" (0,5 mm) to .18" (4,6 mm)

Mounting Hole Diameter Range: .18" (4,6 mm) to 3.00" (76,2 mm)

PANEL DIMENSIONS				PART NO.	DESCRIPTION	PART DIMENSIONS					
Thickness Range		Mounting Hole Diameter Range				Black	A		B	C	
in.	mm.	in.	mm.		Head Diameter		Bottom Diameter	Overall Height	in.	mm.	
Recessed Head - for Panel Thicknesses from .02" (0,5 mm) to .18" (4,6 mm)											
.02-.10	0,51-2,54	.37-.39	9,4-9,9	9610	SMP R-375	.75	19,1	.41	10,4	.31	7,9
.02-.07	0,51-1,78	.50-.52	12,7-13,2	9611	SMP R-500	.85	21,6	.55	14,0	.29	7,4
.02-.14	0,51-3,56	.73-.76	18,5-19,3	9614	SMP R-750	1.16	29,5	.79	20,1	.34	8,6
.02-.07	0,51-1,78	.79-.82	20,1-20,8	9615	SMP R-812	1.15	29,2	.85	21,6	.29	7,4
.02-.10	0,51-2,54	.87-.90	22,1-22,9	9616	SMP R-875	1.23	31,2	.93	23,6	.35	8,9
		.99-1.02	25,2-25,9	9618	SMP R-1000	1.35	34,3	1.05	26,7		
		1.04-1.07	26,4-27,2	9619	SMP R-1062	1.40	35,6	1.10	27,9		
		1.09-1.12	27,7-28,5	9620	SMP R-1093	1.47	37,3	1.16	29,5		
.02-.18	0,51-4,57	1.10-1.15	27,9-29,2	9621	SMP R-1125	1.53	38,9	1.18	30,0	.43	10,9
.01-.10	0,25-2,54	1.23-1.27	31,2-32,3	9622	SMP R-1250	1.60	40,6	1.30	33,0	.35	8,9
		1.30-1.34	33,0-34,0	9623	SMP R-1312	1.67	42,4	1.36	34,5		
.02-.10	0,51-2,54	1.36-1.40	34,6-35,6	9624	SMP R-1375	1.73	43,9	1.43	36,3	.36	9,1
		1.48-1.52	37,6-38,6	9625	SMP R-1500	1.85	47,0	1.55	39,4		
.03-.10	0,76-2,54	1.59-1.65	40,4-41,9	9627	SMP R-1625	2.00	50,8	1.68	42,7	.36	9,1
.02-.10	0,51-2,54	1.75	44,5	9628	SMP R-1750	2.13	54,1	1.80	45,7	.35	8,9
		1.85-1.90	47,0-48,3	9631	SMP R-1875	2.24	56,9	1.93	49,0		
.02-.10	0,51-2,54	1.97-2.02	50,0-51,3	9632	SMP R-2000	2.35	59,7	2.05	52,1	.36	9,1
		2.50	63,5	9633	SMP R-2.5	3.00	76,2	2.57	65,3		
		3.00	76,2	9635	SMP R-3.0	3.56	90,4	3.06	77,7		

Flush Head - for Panel Thicknesses from .02" (0,5 mm) to .11" (2,8 mm)

.02-.04	0,51-1,02	.18-.19	4,6-4,9	9640	SMP F-M5*	.39	9,9	.21	5,3	.21	5,3
.02-.06	0,51-1,52	.23-.24	5,8-6,1	9641	SMP F-M6*	.50	12,7	.29	7,4	.45	11,4
.02-.07	0,51-1,78	.24-.25	6,1-6,4	9642	SMP F-250*	.50	12,7	.28	7,1	.21	5,3
.02-.05	0,51-1,27	.37-.38	9,4-9,7	9644	SMP F-375	.75	19,1	.41	10,4	.19	4,8
.03-.06	0,76-1,52	.43-.45	10,9-11,4	9646	SMP F-437	.69	17,5	.47	11,9	.22	5,6
.03-.08	0,76-2,03	.49-.51	12,5-13,0	9647	SMP F-500	.86	21,8	.54	13,7	.25	6,4
		.55-.56	14,0-14,2	9648	SMP F-562	.87	22,1	.60	15,2		
.06-.08	1,52-2,03	.62	15,7	9649	SMP F-625	.81	20,6	.67	17,0	.29	7,4
.03-.08	0,76-2,03	.68-.70	17,3-17,8	9650	SMP F-687	1.01	25,7	.73	18,5		
.05-.11	1,27-2,79	.73-.76	18,5-19,3	9651	SMP F-750	1.01	25,7	.79	20,1	.25	6,4
.03-.08	0,76-2,03	.86-.88	21,8-22,4	9654	SMP F-875	1.16	29,5	.91	23,1		
		.92-.95	23,4-24,1	9656	SMP F-937	1.31	33,3	.98	24,9		
		1.00	25,4	9657	SMP F-1000	1.38	35,1	1.04	26,4		
.02-.18	0,51-4,57	1.10-1.15	27,9-29,2	9660	SMP F-1125	1.53	38,9	1.18	30,0	.43	10,9
.03-.08	0,76-2,03	1.16-1.20	29,5-30,5	9661	SMP F-1187	1.56	39,6	1.22	31,0	.25	6,4
		1.25	31,8	9663	SMP F-1250	1.62	41,1	1.29	32,8		
		1.29-1.33	32,8-33,8	9664	SMP F-1312	1.68	42,7	1.36	34,6		
		1.50	38,1	9665	SMP F-1500	1.88	47,8	1.54	39,1		
		1.75	44,5	9666	SMP F-1750	2.12	53,8	1.79	45,5		
		1.98-2.01	50,3-51,1	9667	SMP F-2000	2.36	59,9	2.04	51,8		
		2.50	63,5	9669	SMP F-2.5	3.00	76,2	2.56	65,0		
3.00	76,2	9671	SMP F-3.0	3.36	85,3	3.06	77,7				

Standard color black.

* Molded from EVA.

Quick Specs

Material	EVA* and LDPE
Temperature Range	-98°F (-68°C) to 140°F (60°C) (EVA) -94°F (-70°C) to 150°F (66°C) (LDPE)

“Stay Connected” with



Bushings, Grommets, HEYcaps & Plugs

a PennEngineering® Company

HEYCaps™ and Plugs for Round Tubing

CRT Series Caps – Clearance Fit



TUBE A Outside Dia.		PART NO. Black	DESCRIPTION	HEYCap B Height	
in.	mm.			in.	mm.
Standard Duty					
.25	6,4	G5200	CRT 25	.46	11,7
.38	9,5	G5201	CRT 38		
.50	12,7	G5202	CRT 50	.59	15,0
.63	15,9	G5203	CRT 63		
.75	19,1	G5204	CRT 75	.71	18,0
.88	22,2	G5205	CRT 88		
1.00	25,4	G5207	CRT 100	.85	21,6
1.13	28,6	G5208	CRT 113		
1.25	31,8	G5209	CRT 125	.98	24,9
1.50	38,1	G5210	CRT 150		
1.75	44,5	G5211	CRT 175	1.10	27,9
Heavy Duty					
Depth					
.75	19,1	G5212	CRT 75H	.50	12,7
.88	22,2	G5213	CRT 88H		
1.00	25,4	G5214	CRT 100H	.62	15,8
1.13	28,6	G5215	CRT 113H		
1.25	31,8	G5216	CRT 125H		

Standard color black.

PRT Series Plugs – Ribbed Fit

TUBE DIMENSIONS					PART NO. Black	DESCRIPTION	PART DIMENSIONS			
Inside Diameter Range		Typical Gauge	A Outside Diameter				B Depth			
Minimum in.	Maximum mm.		in.	mm.			in.	mm.		
.31	7,9	.33	8,4	13 - 14	G5220	PRT 50-13	.50	12,7	.45	11,4
.37	9,4	.43	10,9	16 - 20	G5221	PRT 50-16	.63	15,9	.44	11,2
.46	11,7	.56	14,2	14 - 20	G5223	PRT 63-14				
.58	14,7	.68	17,3	14 - 20	G5224	PRT 75-14	.75	19,1	.52	13,2
.61	15,5	.71	18,1	10 - 14	G5225	PRT 88-10				
.71	18,0	.91	23,1	14 - 20	G5226	PRT 88-14	.88	22,2	.52	13,2
.73	18,5	.83	21,1	10 - 14	G5227	PRT 100-10				
.83	21,0	.93	23,6	14 - 20	G5228	PRT 100-14	1.00	25,4	.52	13,2
.96	23,4	1.06	26,9	14 - 20	G5229	PRT 113-14				
.98	24,9	1.08	27,4	10 - 14	G5230	PRT 125-10	1.25	31,8	.50	12,7
1.08	27,4	1.18	30,0	14 - 20	G5231	PRT 125-14				
1.21	30,7	1.31	33,3	14 - 20	G5232	PRT 138-14	1.34	34,9	.52	13,2
1.17	29,7	1.28	32,5	8 - 12	G5233	PRT 150-08				
1.23	21,2	1.33	33,8	10 - 14	G5234	PRT 150-10	1.50	38,1	.59	15,0
1.33	33,8	1.43	36,3	14 - 20	G5235	PRT 150-14				
1.36	34,5	1.46	37,1	10 - 14	G5236	PRT 163-10	1.63	41,3	.67	17,0
1.46	37,0	1.56	39,6	14 - 20	G5237	PRT 163-14				
1.48	37,6	1.58	40,1	10 - 14	G5238	PRT 175-10	1.75	44,5	.66	16,8
1.58	40,1	1.68	42,7	14 - 20	G5239	PRT 175-14				
1.73	43,9	1.83	46,5	10 - 14	G5241	PRT 200-10	1.95	49,5	.66	16,8
1.83	46,5	1.93	49,0	14 - 20	G5242	PRT 200-14				
1.86	47,2	2.00	50,8	10 - 14	G5243	PRT 213-10	2.13	54,0	.66	16,8
1.98	50,3	2.08	52,8	10 - 14	G5244	PRT 225-10				
2.08	52,8	2.18	53,4	14 - 20	G5245	PRT 225-14	2.25	57,2	.66	16,8
2.11	53,6	2.21	56,1	10 - 14	G5246	PRT 238-10				
2.17	55,1	2.28	57,9	8 - 12	G5247	PRT 250-08	2.50	63,5	.69	17,5
2.43	61,7	2.47	62,7	14 - 20	G5248	PRT 250-14				

Standard color black.

Material	LDPE
Temperature Range	-94°F (-70°C) to 150°F (66°C)

CRT – Standard Duty

- HEYCaps Series CRT Caps for Round Tubing make **economical, attractive glides** for household and patio furniture; office tables, chairs and equipment; utility carts and exercise equipment.
- As **finishing caps** for both tubing and rods, they cover any scratches, burrs or distortions that may result from cutting operations.
- Provide protection against injury from sharp rod and tubing edges.
- See pages 6-51 and 6-52 for Heyco Plugs for Square and Rectangular Tubing.

CRT – Heavy Duty

- Heavy Duty Caps **finish the ends of round tubing** on numerous products such as furniture, lawn and garden equipment, tools and appliances.
- **Thick wall construction** makes them ideal for threaded connections where extra protection is required.
- Designed for **easy installation**.
- **Seat with a firm grip** that prevents accidental removal.

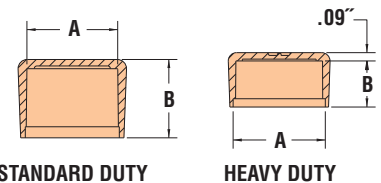

PRT Series

- With durable construction and **excellent gliding edges**, Heyco PRT Series Plugs for Round Tubing may be used on a wide range of metal furniture, appliances, and similar items.
- **Tapered rib design** ensures a secure fit.
- A **thick, impact and abrasion resistant base** makes PNT Series Plugs ideal tubing closures for products subject to heavy-duty service or exposure to adverse environments.
- Not subject to rust or corrosion.
- For larger diameter sizes, please consult Heyco.

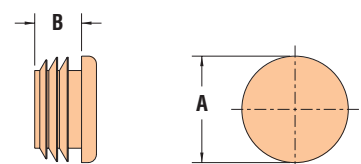



- Heyco Series PST Plugs for Square Tubing **finish raw tubing ends** with a clean finish.
- Sized for different gauges, **fit flush with tubing sides.**
- **Keep dirt and moisture out** of sensitive areas.
- All PST Series Plugs are **.50" (12,7 mm) in depth.**
- **Protect against injury** from sharp tubing edges.
- See page 6-50 for HEYcaps and Plugs for Round Tubing
- See page 6-52 for Heyco Plugs for Rectangular Tubing.

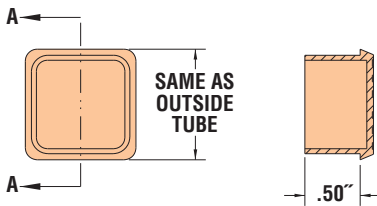

Heyco® Plugs for Square Tubing

PST Series - Clearance Fit

TUBE DIMENSIONS				Typical Gauge	PART NO. Black	DESCRIPTION
Outside Dimension		Inside Dimension				
in.	mm.	in.	mm.			
.50	12,7	.37	9,4	16	G5260	PST 50-16
.75	19,1	.62	15,7	16	G5261	PST 75-16
1.00	25,4	.76	19,3	11	G5262	PST 100-11
		.83	21,1	14	G5263	PST 100-14
		.87	22,1	16	G5264	PST 100-16
		.90	22,9	18	G5265	PST 100-18
		.93	23,6	20	G5266	PST 100-20
1.25	31,8	1.01	25,7	11	G5267	PST 125-11
		1.08	27,4	14	G5268	PST 125-14
		1.12	28,4	16	G5269	PST 125-16
1.50	38,1	1.26	32,0	11	G5270	PST 150-11
		1.33	33,9	14	G5271	PST 150-14
		1.37	34,8	16	G5272	PST 150-16
2.00	50,8	1.76	44,7	11	G5273	PST 200-11
		1.83	46,6	14	G5274	PST 200-14
		1.87	47,5	16	G5275	PST 200-16

Standard color black.

PSTR Series - Ribbed Fit

TUBE DIMENSIONS					PART NO. Black	DESCRIPTION	PART DIMENSIONS			
Inside Dimension Range		Typical Gauge	A Outside Dimension				B Depth			
Minimum	Maximum		in.	mm.			in.	mm.		
in.	mm.		in.	mm.	in.	mm.				
.37	9,4	.40	10,2	16 - 18	G5280	PST R-50-16	.50	12,7	.44	11,2
.46	11,8	.56	14,2	14 - 20	G5281	PST R-63-14	.63	15,9	.43	10,9
.48	12,2	.58	14,8	10 - 14	G5282	PST R-75-10	.75	19,1		
.58	14,8	.68	17,3	14 - 20	G5283	PST R-75-14	.75	19,1		
.71	18,1	.81	20,6	14 - 20	G5284	PST R-88-14	.88	22,2		
.73	18,6	.83	21,2	10 - 14	G5285	PST R-100-10	1.00	25,4		
.83	21,2	.93	23,6	14 - 20	G5287	PST R-100-14	1.00	25,4	.49	12,4
.96	24,5	1.06	26,9	14 - 20	G5289	PST R-113-14	1.13	28,6		
.98	24,9	1.08	27,5	10 - 14	G5290	PST R-125-10	1.25	31,8	.52	13,2
1.08	27,5	1.18	30,0	14 - 20	G5291	PST R-125-14	1.25	31,8		
1.11	28,2	1.21	30,8	10 - 14	G5292	PST R-138-10	1.38	34,9		
1.21	30,8	1.31	33,3	14 - 20	G5293	PST R-138-14	1.38	34,9		
1.23	31,3	1.33	33,9	10 - 14	G5294	PST R-150-10	1.50	38,1		
1.33	33,9	1.43	36,3	14 - 20	G5295	PST R-150-14	1.50	38,1		
1.48	37,6	1.58	40,2	10 - 14	G5296	PST R-170-10	1.75	44,5		
1.58	40,2	1.68	42,7	14 - 20	G5297	PST R-170-14	1.75	44,5		
1.52	38,7	1.67	42,4	4 - 8	G5298	PST R-200-04	2.00	50,8		
1.73	44,0	1.83	46,6	10 - 14	G5299	PST R-200-10				
1.83	46,6	1.93	49,0	14 - 20	G5300	PST R-200-14	2.25	57,2		
1.98	50,3	2.08	52,9	10 - 14	G5301	PST R-225-10				
2.09	53,2	2.23	56,7	6 - 10	G5302	PST R-250-06	2.50	63,5	.56	14,2
2.23	56,7	2.33	59,3	10 - 14	G5303	PST R-250-10	2.50	63,5	.50	12,7
2.37	60,2	2.45	62,2	16 - 23	G5304	PST R-250-16	2.50	63,5	.56	14,2

Standard color black.

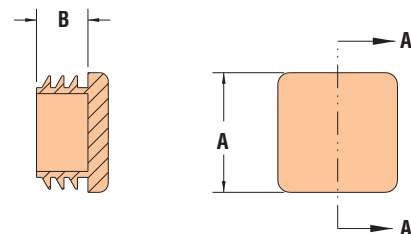

Material LDPE
 Temperature Range -94°F (-70°C) to 150°F (66°C)

Heyco® Ergonomic Plugs for Square Tubing

PSTE Series - Vinyl for Greater Flexibility

TUBE DIMENSIONS Inside					PART NO. Black	DESCRIPTION	PART DIMENSIONS			
Dimension Range		Typical Gauge	A Outside Dimension				B Depth			
Minimum in.	Maximum mm.		in.	mm.			in.	mm.		
.58	14,7	.68	17,3	14 - 20	G5320	PST E-75-14	.75	19,1	.43	10,9
.73	18,5	.83	21,1	10 - 14	G5321	PST E-100-10	1.00	25,4		
.83	21,1	.93	23,6	14 - 20	G5322	PST E-100-14				
1.08	27,4	1.18	30,0	14 - 20	G5323	PST E-125-14	1.25	31,8	.52	13,2
1.23	31,2	1.33	33,8	10 - 14	G5324	PST E-150-10	1.50	38,1		
1.33	33,8	1.43	36,3	14 - 20	G5325	PST E-150-14				
1.73	43,9	1.83	46,5	14 - 20	G5326	PST E-200-10	2.00	50,8		

Standard color black.

Heyco® Plugs for Rectangular Tubing

PZT Series - Ribbed Fit

TUBE DIMENSIONS					PART NO. Black	DESCRIPTION	PLUG Depth C				
Outside Dimensions A		Wall Thickness in.	Typical Gauge	B			in.	mm.			
in.	mm.										
.50	12,7	1.00	25,4	.065 - .049	16 - 18	G5330	PZT 50-100-16	.43	10,9		
		1.50	38,1	.083 - .035	14 - 20	G5331	PZT 50-150-14	.50	12,7		
.63	15,9	1.12	28,6	.083 - .035	14 - 20	G5332	PZT 63-112-14	.43	10,9		
		1.25	31,8	.083	14	G5334	PZT 63-125-14	.50	12,7		
		1.38	34,9	.083 - .035	14 - 20	G5335	PZT 63-138-14	.43	10,9		
.75	19,1	1.50	38,1	.083 - .035	14 - 20	G5336	PZT 75-150-14	.43	10,9		
		1.25	31,8	.083 - .035	14 - 20	G5337	PZT 100-125-14	.50	12,7		
1.00	25,4	1.50	38,1	.134 - .083	10 - 14	G5338	PZT 100-150-10				
				.083 - .035	14 - 20	G5339	PZT 100-150-14				
				.134 - .083	10 - 14	G5340	PZT 100-200-10				
		2.00	50,8	.083 - .035	14 - 20	G5341	PZT 100-200-14				
				.065	16	G5342	PZT 100-200-16			.36	9,1
		2.50	63,5	.083 - .035	14 - 20	G5343	PZT 100-250-14			.45	11,4
1.50	38,1	2.50	63,5	.065 - .049	16 - 18	G5344	PZT 100-250-16	.50	12,7		
		3.00	76,2	.083 - .035	14 - 20	G5345	PZT 100-300-14	.51	13,0		
		2.00	50,8	.134 - .083	10 - 14	G5346	PZT 150-200-10	.50	12,7		
		2.50	63,5	.109 - .065	12 - 16	G5347	PZT 150-250-12	.53	13,5		
1.96	49,8	3.00	76,2	.134 - .083	10 - 14	G5348	PZT 150-300-10	.50	12,7		
		3.50	88,9	.134 - .083	10 - 14	G5349	PZT 150-350-10	.60	15,2		
		2.50	63,5	.203 - .109	6 - 12	G5356	PZT 196-394-06M	.65	16,5		
2.00	50,8	2.50	63,5	.134 - .083	10 - 14	G5351	PZT 200-250-10	.52	13,2		
				.203 - .165	6 - 8	G5352	PZT 200-300-06				
		3.00	76,2	.134 - .083	10 - 14	G5353	PZT 200-300-10	.50	12,7		
				.083 - .035	14 - 20	G5354	PZT 200-300-14				
				.203 - .120	6 - 11	G5355	PZT 200-400-06			.94	23,9
		4.00	101,6	.134 - .083	10 - 14	G5357	PZT 200-400-10	.50	12,7		
				.083 - .035	14 - 20	G5358	PZT 200-400-14				
5.00	127,0	.165	8	G5359	PZT 200-500-08*	1.00	25,4				
		.134	10	G5360	PZT 200-500-10*						

Standard color black.

*Smooth (ie, not ribbed) shank.

Material	PSTE Vinyl	Material	LDPE
Temperature Range	26°F (-32°C) to 200°F (93°C)	Temperature Range	-94°F (-70°C) to 150°F (66°C)



- **Flexible, ribbed design** allows quick and easy fingertip installation.
- **Removable without the use of tools** (Traditional glides and tube plugs are designed to be permanent. Their rigid design makes removal very difficult).
- Injection molded for intricate detail and design, with **flexibility**.
- See page 6-50 for HEYcaps and Plugs for Round Tubing.
- Material: Vinyl. Vinyl **decreases mobility** or sliding on floors, helping to keep your application in place.

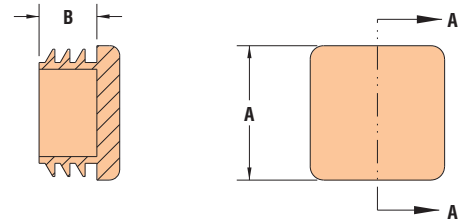

- Featuring the same external rib design of Heyco PSTR Series Plugs for Square Tubing, PZT Series Plugs for Rectangular Tubing are offered in a **broad selection of width-to-length proportions**, to fit many special tubing shapes found on stands for computer terminals, office machines, display fixtures, and similar metal furnishings and equipment.
- **Durable construction** ensures exceptional performance in business and commercial applications.

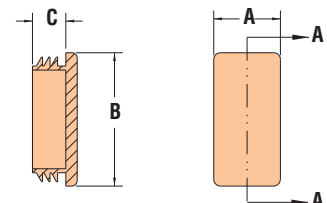



Heyco® Stock and Custom* Colors for Dome Plugs and Shorty Plugs

*CUSTOM Color parts MUST be color matched. For accurate matching, consult Heyco for sample molded nylon color chips.

For complete Dome Plug Part Dimensions and Specifications, see page 6-25.

For complete Shorty Plug Part Dimensions and Specifications, see page 6-27.

- Heyco Stock and Custom Colors are Molded-in, not dyed, Colors.
- Stock and Custom Color Minimum Order Quantities are usually higher than for Black and White parts.
- **STOCK** Color means the color concentrate pellets are in stock at Heyco.
- The Stock Colors shown are **approximate**. Consult Heyco for Stock Color molded nylon color chips.
- Stock Color lead times are typically 2-3 weeks from receipt of order.
- For Stock Color part numbers in other Plug styles, for example Glossy or Double D Plugs, please consult Heyco.
- **CUSTOM** Color parts MUST be color matched to your application. For accurate matching, consult Heyco for sample molded nylon color chips.
- Custom Color lead times are typically 4 weeks from receipt of order.
- **We offer Stock and Custom Colors in virtually all of our nylon molded products.**
- Heyco’s Axcell Rapid Response Team is ready to customize your Plug in various sizes, shapes, materials, and colors. We can even mold your Company logo directly onto your Plug!

MOUNTING HOLE DIA.		PLUG TYPE	ROOT PART NO.	STOCK COLOR PART NUMBER SUFFIX										YOUR CUSTOM COLOR HERE
in.	mm.			FK	FL	FJ	EH	CS	DD	CF	DQ	FI	XX **	
.218	5,5	Shorty	1656	FK	FL	FJ	EH	CS	DD	CF	DQ	FI	XX	
.250	6,4	Dome	2605	FK	FL	FJ	EH	CS	DD	CF	DQ	FI	XX	
.281	7,1	Shorty	1662	FK	FL	FJ	EH	CS	DD	CF	DQ	FI	XX	
.312	7,9	Dome	2615	FK	FL	FJ	EH	CS	DD	CF	DQ	FI	XX	
		Shorty	1680	FK	FL	FJ	EH	CS	DD	CF	DQ	FI	XX	
.343	8,7	Shorty	1665	FK	FL	FJ	EH	CS	DD	CF	DQ	FI	XX	
		Dome	2619	FK	FL	FJ	EH	CS	DD	CF	DQ	FI	XX	
.375	9,5	Shorty	1683	FK	FL	FJ	EH	CS	DD	CF	DQ	FI	XX	
		Dome	2635	FK	FL	FJ	EH	CS	DD	CF	DQ	FI	XX	
.437	11,1	Shorty	1686	FK	FL	FJ	EH	CS	DD	CF	DQ	FI	XX	
		Dome	2645	FK	FL	FJ	EH	CS	DD	CF	DQ	FI	XX	
.500	12,7	Shorty	1689	FK	FL	FJ	EH	CS	DD	CF	DQ	FI	XX	
		Dome	2645	FK	FL	FJ	EH	CS	DD	CF	DQ	FI	XX	
.531	13,5	Shorty	1674	FK	FL	FJ	EH	CS	DD	CF	DQ	FI	XX	
.562	14,3	Dome	2655	FK	FL	FJ	EH	CS	DD	CF	DQ	FI	XX	
		Shorty	1692	FK	FL	FJ	EH	CS	DD	CF	DQ	FI	XX	
.625	15,9	Shorty	1692	FK	FL	FJ	EH	CS	DD	CF	DQ	FI	XX	
		Dome	2675	FK	FL	FJ	EH	CS	DD	CF	DQ	FI	XX	
.687	17,4	Dome	2675	FK	FL	FJ	EH	CS	DD	CF	DQ	FI	XX	
		Shorty	1695	FK	FL	FJ	EH	CS	DD	CF	DQ	FI	XX	
.750	19,1	Dome	2685	FK	FL	FJ	EH	CS	DD	CF	DQ	FI	XX	
		Shorty	1695	FK	FL	FJ	EH	CS	DD	CF	DQ	FI	XX	
.812	20,6	Dome	2695	FK	FL	FJ	EH	CS	DD	CF	DQ	FI	XX	
		Shorty	1701	FK	FL	FJ	EH	CS	DD	CF	DQ	FI	XX	
.875	22,2	Dome	2705	FK	FL	FJ	EH	CS	DD	CF	DQ	FI	XX	
		Shorty	1701	FK	FL	FJ	EH	CS	DD	CF	DQ	FI	XX	
1.000	25,4	Dome	2715	FK	FL	FJ	EH	CS	DD	CF	DQ	FI	XX	
		Shorty	1704	FK	FL	FJ	EH	CS	DD	CF	DQ	FI	XX	
1.093-	27,8-	Dome	2725	FK	FL	FJ	EH	CS	DD	CF	DQ	FI	XX	
1.125	28,6	Shorty	1707	FK	FL	FJ	EH	CS	DD	CF	DQ	FI	XX	
1.187	30,1	Dome	2735	FK	FL	FJ	EH	CS	DD	CF	DQ	FI	XX	
1.250	31,7	Dome	2742	FK	FL	FJ	EH	CS	DD	CF	DQ	FI	XX	
1.375	34,9	Dome	2755	FK	FL	FJ	EH	CS	DD	CF	DQ	FI	XX	
1.500	38,1	Dome	2765	FK	FL	FJ	EH	CS	DD	CF	DQ	FI	XX	
1.750	44,5	Dome	2775	FK	FL	FJ	EH	CS	DD	CF	DQ	FI	XX	
2.000	50,8	Dome	2785	FK	FL	FJ	EH	CS	DD	CF	DQ	FI	XX	
2.5	63,5	Dome	2792	FK	FL	FJ	EH	CS	DD	CF	DQ	FI	XX	
3.0	76,2	Dome	2457	FK	FL	FJ	EH	CS	DD	CF	DQ	FI	XX	

**xx indicates that, following the color match process, Heyco will add a two letter suffix to the Root Part Number shown. This suffix will identify your particular CUSTOM Color selection. Consult Heyco for molded nylon color chips for accurate matching.



Your logo here

HEYware

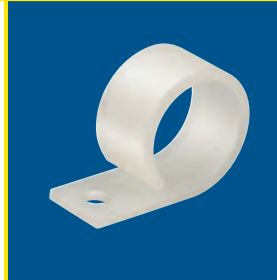
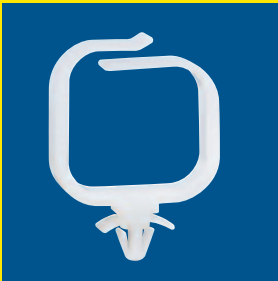

a PennEngineering® Company

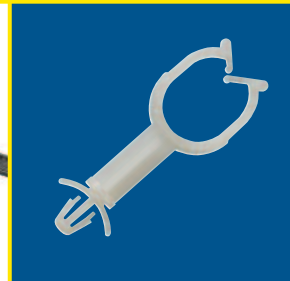
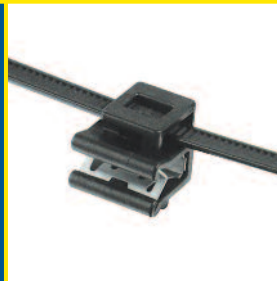
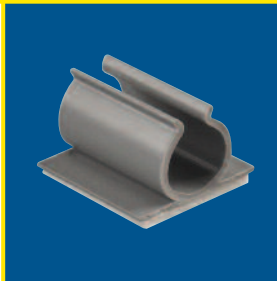
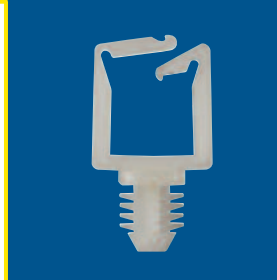
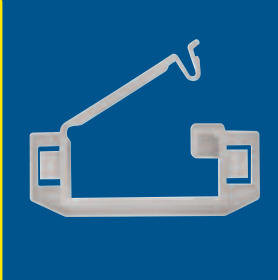
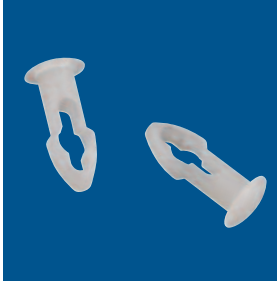
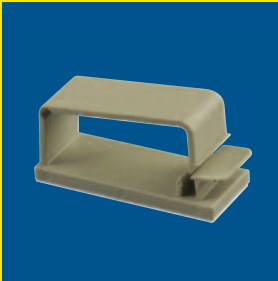

CONTENTS

Pictorial Contents	I – IV
PCB Supports Selection Guide	7-1 – 7-3
PCB Supports	7-4 – 7-29
Nylon Threaded Hex Supports and Tapped Hex Spacers	7-30, 7-31
Standard Plus Nylon Washers and Spacers	7-32, 7-33
LED Spacers	7-34, 7-35
Transistor Insulators	7-35
Cable, Wire Harness and Hose Clamps	7-36 – 7-41
Stainless Steel Cable Clamps, Cushion Clamps and Clips	7-42 – 7-45
HEYClip™ Tension Wire Clips, MaxRunner® Cable Clip Arrays, Wave Locks, Lockit Loops and Clips, Locking Releasable Wire Clips and Cable Holders	7-46 – 7-63
Hinged Edge Strain Relief Bushings	7-61
Nytye® Nylon Cable Ties, Mounting Platforms, Nytyes with Stainless Steel Locking Device, Heavy Duty Stainless Steel Wire Cable Ties, Stainless Steel Cable Ties, Edge Clip Nytyes and Beaded Ties	7-64 – 7-73
Braided Sleeving, Hose and Cable Wrap, Heyco-Flex™ Slit Tubing	7-73 – 7-75
HEYClip Fasteners - Rivets	7-76 – 7-82
HEYClip Fasteners - Drive Fasteners, Mounting Buttons, Fastener Plug, Arrow Clips, Shorty Mounting Buttons, Kayak Clips, Holster Clips and Push-In Fasteners	7-83 – 7-86
HEYClip Snap Lock Pins, Turn Fastener and Pawl Locks	7-87
Rubber and Polyurethane Bumpers and Feet	7-88 - 7-94
Latches and Strikers, Push Latches and Snap Latch Rivets	7-95 - 7-96
HEYware LabKits	7-97

Pictorial Contents



7-4 PCB Imperial Spacing
- HSP1, HSP2, HSP3



7-4 PCB Imperial Spacing
- HDLSPTH



7-5 PCB Imperial Spacing
- HLSP1, HLSP2, HLSP3



7-5 PCB Imperial Spacing
- HLSP4



7-6 PCB Imperial Spacing
- HLSP5



7-6 PCB Imperial Spacing
- HLSP6



7-6 PCB Imperial Spacing
- HLSP7



7-6 PCB Imperial Spacing
- HLSP8



7-7 PCB Imperial Spacing
- HLSP9



7-7 PCB Imperial Spacing
- HLSP10



7-7 PCB Imperial Spacing
- HLSP11



7-7 PCB Imperial Spacing
- HTLSP



7-8 PCB Imperial Spacing
- HDLSP4, HDLSP5, HDLSP6,
HDLSP7



7-9 PCB Imperial Spacing
- HPS



7-9 PCB Imperial Spacing
- HCDLCBST



7-9 PCB Imperial Spacing
- HSSL, HLNCBS



7-10 PCB Imperial Spacing
- HMCBP, HCBP



7-10 PCB Imperial Spacing
- HMSPDLN, HMSPDL



7-11 PCB Imperial Spacing
- HMSPS



7-11 PCB Imperial Spacing
- HMPS



7-11 PCB Imperial Spacing
- HPS-TD



7-11 PCB Imperial Spacing
- HSP-MDL-3



7-12 PCB Metric Spacing
- HSP-MDL-1, HSP-MDL-2,
HSP-MDLS-1, HSP-MDLS-2



7-13 PCB Metric Spacing
- HSP-MDL-AH-1



7-13 PCB Metric Spacing
- HDLSP1, HDLSP2,
HDLSP3



7-14 PCB Reverse Locking
Supports - HLCBSC2



7-14 PCB Reverse Locking
Supports - HLCBSC3



7-14 PCB Reverse Locking
Supports - HLCBSC4,
HLCBSC5



7-15 PCB Reverse Locking
Supports - HLCBSC6,
HLCBSC7



7-15 PCB Reverse Locking
Supports - HLCBSC8



7-15 PCB Reverse Locking
Supports - HLCBSC9



7-16 PCB Reverse Locking
Supports - HLCBSC11



7-16 PCB Reverse Locking
Supports - HLCBSC12-2



7-16 PCB Reverse Locking
Supports - HLCBSC13



7-16 PCB Reverse Locking
Supports - HCPS



7-17 PCB Reverse Locking
Supports - Metric -
HLCBSC



7-17 PCB Reverse Locking
Supports - Metric -
HLCBSC10



7-18 PCB Blind Mount -
HBS



7-18 PCB Blind Mount -
HBS2



7-18 PCB Blind Mount -
HBS3



7-18 PCB Blind Mount -
HBS4



7-19 PCB Blind Mount - HBS5



7-19 PCB Blind Mount - HBS6



7-19 PCB Key Slot Mount - HKSLBN



7-20 PCB Stackable Self-Retaining Spacers - HSSRS4, HSSRS6, HSSRS8



7-21 PCB Thru Hole Self-Retaining Spacers - HRSR4, HRSR6, HRSR8



7-22 PCB Screw & Lock Supports - HHCBS, HLCBS-TF-M4



7-22 PCB Screw & Lock Supports - HLCBS-TF-632, HTCBS-TF-632



7-23 PCB Threaded Male - HSCBS3, HSCBS4, HSCBS5



7-24 PCB Threaded Male - HSCBS6, HSCBS7, HSCBS8, HSCBS



7-25 PCB Threaded Male - HSCBS1-632, HSCBS1-M3, HSCBS1-M4



7-25 PCB Threaded Male - HCBS-TMM



7-26 PCB Adhesive-Back Mount - HCBS



7-26 PCB Adhesive-Back Mount - HCBS2



7-26 PCB Adhesive-Back Mount - HCBS3



7-26 PCB Adhesive-Back Mount - HCBS4



7-27 PCB Adhesive-Back Mount - Metric - HCBS

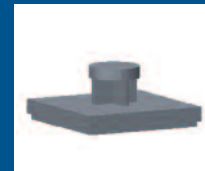

7-27 PCB Adhesive-Back Mount - Metric HPSB



7-28 PCB Rivet Mount - HRLSP



7-28 PCB Rivet Mount - HSRLAHS



7-29 PCB Edge Holding - HTEHCBS



7-29 PCB Edge Holding - HEHCBS-7



7-29 PCB Edge Holding - HRLHCBS



7-30 Nylon Threaded Hex Supports - MFS4, MFS6, MFS8, MFSM3



7-31 Nylon Tapped Hex Spacers Imperial Spacing - HST23, HST43, HST44, HST63, HST64



7-31 Nylon Tapped Hex Spacers Metric Spacing - HSTM35, HSTM46, HSTM61



7-32 & 7-33 Standard Plus Nylon Washers & Spacers



7-34 LED Spacers - HLEDM-1



7-34 LED Spacers - HLEDM-2



7-34 LED Spacers - HLEDS2M



7-35 LED Spacers - HLEDS2



7-35 LED Spacers - HLEDS3



7-35 LED Spacers - HLEDS1E



7-35 LED Spacers - HLEDS2E



7-35 Transistor Insulators



7-36 Nylon Cable Clamps



7-37 Nylon Cable Clamps - Push Lock & Snap Lock



7-38 Nylon Wire Harness Clamps



7-38 Nylon Lockit Hose Clamps



7-39 Nylon Hose Clamps



7-40 Nylon Self-aligning Cable Clamps



7-40 Hinged Locking Cable Clamps



7-41 Compression Cable Clamps



7-41 Cable Stays - Adhesive Back Mount



7-42 Stainless Steel Cable Clamps



7-42 Steel Cushion Clamps



7-43 HEYClip Vinyl Coated Steel Clips - Screw & Adhesive Mount



7-43 HEYClip Vinyl Coated Steel Clips - Spring Clamp



7-44 HEYClip SunRunner Cable Clips



7-44 HEYClip SunRunner EZ Cable Clip



7-44 HEYClip SunRunner 4 & 4 EZ Cable Clips



7-45 HEYClip SunRunner 90, 90-2 & 90-4 Cable Clips

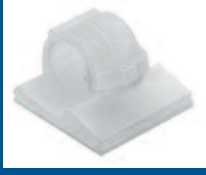

7-46 HEYClip Tension Wire Clips-Nylon

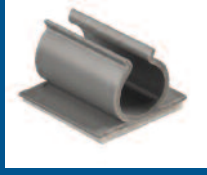

7-47 HEYClip Tension Wire Clips-Vinyl



7-48 HEYClip MaxRunner Cable Clip Arrays



7-49 HEYClip Wave Locks

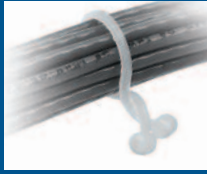

7-50 HEYClip Standard Lockit Loops



7-50 HEYClip Standoff Lockit Loops - Arrowhead Mount



7-51 HEYClip Standard Lockit Loops - Blind and Arrowhead Mount



7-52 HEYClip Locking Releasable Wire Clips - Arrowhead Mount



7-53 HEYClip Locking Releasable Wire Clips - Adhesive Back Mount



7-53 HEYClip Locking Releasable Wire Clips - Adjustable



7-54 HEYClip Cable Holders - Snap Rivet Mount



7-54 HEYClip Cable Holders - Two Prong Mount



7-55 HEYClip Shorty Cable Holders - Arrowhead Mount

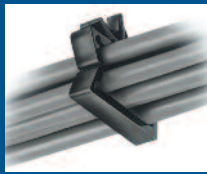

7-56 HEYClip Cable Holders - Top & Side Entry, Arrowhead Mount



7-57 HEYClip Cable Holders - Blind Mount



7-57 HEYClip Cable Holders - Adhesive Back Mount



7-58 HEYClip Cable Holders - Standoff



7-58 HEYClip Cable Holders - Round



7-59 HEYClip Cable Holders - Lockit, Arrowhead Mount



7-60 HEYClip Cable Holders - Hinged



7-60 HEYClip Locking Releasable Cable Holders - Hinged Edge

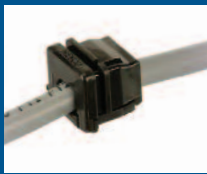

7-61 Hinged Edge Strain Relief Bushings



7-61 HEYClip Edge Cable Holders



7-62 HEYClip Shorty Side Entry Cable Holders



7-62 HEYClip Ladder Cable Holders



7-63 HEYClip Split Dart Cable Holders



7-63 HEYClip Optical Fiber Network Cable Holders



7-64 Nytye Nylon Cable Ties - Miniature, Intermediate, Standard



7-65 Nytye Heavy Duty and Extra Heavy Duty/HVAC Nylon Cable Ties



7-65 Nytye Double Loop Cable Ties



7-66 Nytye Push Mount Nylon Cable Ties



7-67 Nytye Nylon Cable Ties Variations



7-68 Nytye Mounting Platforms - Flat & Saddle Platforms



7-69 Nytye Mounting Platforms - Push Mount, Snap Over & Steel Edge Clip Platform



7-70 Nytyes with Stainless Steel Locking Device



7-70 Heavy Duty Stainless Steel Wire Cable Ties



7-71 Stainless Steel Cable Ties - Standard & PVC Coated

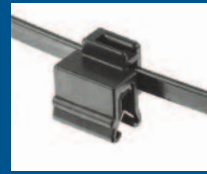

7-72 Edge Clip Nytyes



7-73 Beaded Ties

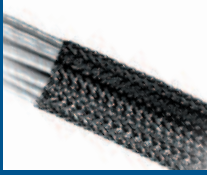

7-73 Braided Sleeving



7-74 & 7-75 Hose & Cable Wrap - Polyethylene, Nylon



7-75 Heyco-Flex V Nylon Slit Tubing



7-76 & 7-77 HEYClip Nylon Snap Rivets



7-77 HEYClip Heat Resistant Snap Rivets



7-78 HEYClip Countersunk Type H Rivets



7-78 HEYClip Drive Rivets



7-79 HEYClip Releaseable Type T Rivets



7-79 HEYClip Type P Snap Rivets



7-80 HEYClip Shorty Snap Rivets



7-80 HEYClip Ratchet Rivets



7-81 HEYClip Unscrewing Snap Rivets & Tough Rivets



7-81 HEYClip Removable Rivets



7-82 HEYClip Blunt Rivets



7-82 HEYClip Expansion Rivets



7-83 HEYClip Drive Fasteners



7-83 HEYClip Mounting Buttons & Fastener Plug



7-84 HEYClip Nylon Arrow Clips



7-84 HEYClip Shorty Mounting Buttons



7-85 HEYClips Kayak & Holster Clips



7-86 HEYClip Nylon Push-In & Thick Panel Push-In Fasteners



7-87 HEYClip Snap Lock Pins



7-87 HEYClip Turn Fastener



7-87 HEYClip Pawl Locks



7-88 & 7-89 Rubber Push-In Bumpers



7-90 Rubber Screw In Pocket Bumpers



7-91 Polyurethane Adhesive Back Bumpers



7-92 Break Away Bumpers



7-92 Feet of Strength - FSD & FSS Series



7-93 Feet of Strength - FSR Series



7-94 Snap In Feet



7-94 Low Profile Snap In Feet



7-95 Latches and Strikers



7-96 Push Latches



7-96 Snap Latch Rivets



7-97 HEYware LabKits

Heyco® PCB Supports Selection Guide

Imperial Spacing Lengths

PCB Mounting Hole Diameter		CHASSIS				MOUNTING STYLES		SERIES	PAGE
in.	mm.	Maximum Thickness		Mounting Hole Diameter		PCB End	Chassis End		
		in.	mm.	in.	mm.				

Flat Rest Mounts

.000	0,0	.062	1,6	.098	2,5	flat rest mount	teardrop snap lock	HPS-TD	7-11
		.078	2,0	.125	3,2	flat rest mount	arrowhead snap lock	HMPS	7-11
				.187	4,8	flat rest mount	arrowhead snap lock	HPS	7-9

For PCB's up to .062" (1,6 mm) Thick

.098	2,5	.039	1,0	.079	2,0	teardrop snap lock	teardrop snap lock	HSP-MDL-3	7-11
		.062	1,6	.098	2,5	teardrop snap lock	teardrop snap lock	HDLSPH	7-4
				cupped teardrop lock	cupped teardrop lock	HCDLCBST	7-9		
				.125	3,2	bayonet snap lock 8,7	teardrop snap lock	HTLSP	7-7
.125	3,2	.062	1,6	.125	3,2	two prong snap lock	two prong snap lock	HMSPDLN	7-10
						two prong snap fit	two prong snap lock	HMCBP	7-10
						bayonet snap lock 8,7	two prong snap lock	HLSP11	7-7
						bayonet snap lock 8,7	arrowhead snap lock	HLSP9	7-7
.152	3,9	.062	1,6	.154	3,9	two prong snap lock	two prong snap lock	HMSPDL	7-10
						two prong snap fit	two prong snap lock	HCBP	7-10
.157	4,0	.055	1,4	.188	4,8	bayonet snap lock 10,2	arrowhead snap lock	HLSP8	7-6
						flanged two prong snap lock	flanged two prong snap lock	HMSPS	7-11
		.062	1,6	.157	4,0	two prong snap lock	two prong snap lock	HSP1	7-4
						two prong snap lock	two prong snap lock	HSP3	7-4
						arrowhead snap lock	arrowhead snap lock	HSSL	7-9
		.078	2,0	.187	4,8	bayonet snap fit 10,2	arrowhead snap lock	HLSP4	7-5
						bayonet snap lock 10,2	arrowhead snap lock	HLSP1	7-5
						arrowhead snap lock	arrowhead snap lock	HLSP7	7-6
						bayonet snap fit 10,2	winged two prong snap lock	HLSP10	7-7
		.141	3,6	.187	4,8	bayonet snap lock 10,2	winged two prong snap lock	HLSP5	7-6
bayonet snap lock 10,2	arrowhead snap lock					HLSP2	7-5		
.187	4,8	.062	1,6	.187	4,8	two prong snap lock	two prong snap lock	HSP2	7-4

For PCB's up to .078" (2,0 mm) Thick

.125	3,2	.078	2,0	.125	3,2	arrowhead snap lock	arrowhead snap lock	HDLSP4	7-8
.157	4,0	.078	2,0	.157	4,0	arrowhead snap lock	arrowhead snap lock	HDLSP5	7-8
				.187	4,8	arrowhead snap lock	arrowhead snap lock	HDLSP7	7-8
.187	4,8	.078	2,0	.187	4,8	arrowhead snap lock	arrowhead snap lock	HDLSP6	7-8
						bayonet snap lock 15,2	arrowhead snap lock	HLNCBS	7-9

For PCB's up to .090" (2,3 mm) Thick

.157	4,0	.078	2,0	.187	4,8	bayonet snap lock 10,9	arrowhead snap lock	HLSP3	7-5
		.141	3,6	.187	4,8	bayonet snap lock 10,9	arrowhead snap lock	HLSP6	7-6

NEW!

Metric Spacing Lengths

PCB Mounting Hole Diameter		CHASSIS				MOUNTING STYLES		SERIES	PAGE
in.	mm.	Maximum Thickness		Mounting Hole Diameter		PCB End	Chassis End		
		in.	mm.	in.	mm.				

For PCB's up to .062" (1,6 mm) Thick

.098	2,5	.062	1,6	.098	2,5	teardrop snap lock	two prong snap lock	HSP-MDL-AH-1	7-13
		.141	3,6	.098	2,5	teardrop snap lock	teardrop snap lock	HSP-MDL-1	7-12
.138	3,5	.062	1,6	.138	3,5	teardrop snap lock	teardrop snap lock	HSP-MDLS-1	7-12
		.141	3,6	.138	3,5	teardrop snap lock	teardrop snap lock	HSP-MDLS-2	7-12
.157	4,0	.062	1,6	.157	4,0	wingless arrowhead	wingless arrowhead	HDLSP1	7-13
				.187	4,8	wingless arrowhead	wingless arrowhead	HDLSP3	7-13
.187	4,8	.062	1,6	.187	4,8	wingless arrowhead	wingless arrowhead	HDLSP2	7-13

Reverse Locking Supports

PCB Mounting Hole Diameter		CHASSIS Maximum Thickness		Mounting Hole Diameter		MOUNTING STYLES		SPACING	SERIES	PAGE						
in.	mm.	in.	mm.	in.	mm.	PCB End	Chassis End									
Flat Rest Mounts																
.000	0,0	.062	1,6	.187	4,8	flat rest mount	reverse button lock	Imperial	HLCBSC3	7-14						
				.213	5,4	flat rest mount	reverse button lock	Imperial	HLCBSC11	7-16						
For PCB's up to .062" (1,6 mm) Thick																
.125	3,2	.062	1,6	.187	4,8	bayonet snap lock 8,7	reverse button lock	Imperial	HLCBSC2	7-14						
						two prong snap lock	reverse button lock	Imperial	HLCBSC8	7-15						
						bayonet snap fit 8,7	reverse button lock	Imperial	HLCBSC9	7-15						
.157	4,0	.047	1,2	.236	6,0	bayonet snap lock 10,2	reverse button lock	Imperial	HLCBSC4	7-14						
						bayonet snap fit 10,2	reverse button lock	Imperial	HLCBSC13	7-16						
						arrowhead snap lock	reverse button lock	Imperial	HCPS	7-16						
		.062	1,6	.213	5,4	.213	5,4	arrowhead snap lock	reverse button lock	Metric	HLCBSC	7-17				
															HLCBSC10	7-17
		.067	1,7	.213	5,4	.250	6,4	bayonet snap lock 10,2	reverse button lock	Imperial	HLCBSC6	7-15				
								bayonet snap lock 10,2	reverse button lock	Imperial	HLCBSC7	7-15				
								bayonet snap lock 10,2	reverse button lock	Imperial	HLCBSC5	7-14				
.078	2,0	.213	5,4			arrowhead snap lock	reverse button lock	Imperial	HLCBS12-2	7-16						

Blind and Key Slot Mount Supports

PCB Mounting Hole Diameter		CHASSIS Maximum Thickness*		Mounting Hole Diameter		MOUNTING STYLES		SPACING	SERIES	PAGE
in.	mm.	in.	mm.	in.	mm.	PCB End	Chassis End			
Blind Mount, for PCB's up to .062" (1,6 mm) Thick										
.157	4,0	.250	6,4	.250	6,4	bayonet snap lock 10,2	blind fir tree	Imperial	HBS4	7-18
						bayonet snap fit 10,2	blind fir tree	Imperial	HBS5	7-19
						bayonet snap lock 10,2	blind fir tree	Imperial	HBS	7-18
						bayonet snap fit 10,2	blind fir tree	Imperial	HBS2	7-18
Blind Mount, for PCB's up to .078" (2,0 mm) Thick										
.157	4,0	.250	6,4	.250	6,4	arrowhead snap lock	blind fir tree	Imperial	HBS6	7-19
				.312	7,9	arrowhead snap lock	blind fir tree	Imperial	HBS3	7-18
Key Slot Mount - for PCB's up to .062" (1,6 mm) Thick										
.157	4,0	.062	1,6	.157	4,0	bayonet snap lock 10,2	key slot	Imperial	HKSLBN	7-19

*Minimum thickness for Blind Mount †For Panel Thicknesses see Rivet Table on page 19.

Self-Retaining Spacers

PCB Mounting Hole Diameter		CHASSIS Maximum Thickness		Mounting Hole Diameter		MOUNTING STYLES		SPACING	SERIES	PAGE
in.	mm.	in.	mm.	in.	mm.	PCB End	Chassis End			
For PCB's up to .062" (1,6 mm) Thick										
.185	4,7	varies ††	#4	M3		two prong snap lock	self-tap screw #4 or M3	Imperial	HSSRS4 †	7-20
						two prong snap lock	self-tap screw #4 or M3	Imperial	HSRS4	7-21
.232	5,9	varies ††	#6	M3		two prong snap lock	self-tap screw #6 or M3	Imperial	HSSRS6 †	7-20
						two prong snap lock	self-tap screw #6 or M3	Imperial	HSRS6	7-21
						two prong snap lock	self-tap screw #8 or M4	Imperial	HSSRS8 †	7-20
						two prong snap lock	self-tap screw #8 or M4	Imperial	HSRS8	7-21

†Stackable ††Thread Depth varies with length of part.

Screw and Lock Supports

PCB Mounting Hole Diameter		PART DATA Thread Depth		Mounting Screw		MOUNTING STYLES		SPACING	SERIES	PAGE
in.	mm.	in.	mm.	in.	mm.	PCB End	Chassis End			
For PCB's up to .062" (1,6 mm) Thick										
.157	4,0	.312	7,9	#6		bayonet snap lock 10,2	self-tap screw #6	Imperial	HHCBS	7-22
		varies †			M4	bayonet snap lock 10,2	female thread #M4	Imperial	HLCBS-TF-M4	7-22

Screw and Lock Supports - continued

PCB Mounting Hole Diameter		PART DATA				MOUNTING STYLES		SPACING	SERIES	PAGE
in.	mm.	Thread Depth		Mounting Screw		PCB End	Chassis End			
For PCB's up to .062" (1,6 mm) Thick										
.157	4,0	varies †			M4	bayonet snap fit 10,2	female thread #M4	Imperial	HCBS-TF-M4	Consult Heyco
		varies †			6-32	bayonet snap lock 10,2	female thread 6-32	Imperial	HLCBS-TF-632	7-22
						bayonet snap fit 10,2	female thread 6-32	Imperial	HCBS-TF-632	7-22
PCB Thickness Varies										
.157	4,0	varies †			M3	bayonet snap lock 9,5	female thread M3	Metric	HTCBS-M3-6	Consult Heyco
					M4	bayonet snap lock 9,5	female thread M4		HTCBS-M3-8	
								HTCBS-M4-8		

†Thread Depth varies with length of part.

Threaded Male Supports

PCB Mounting Hole Diameter		CHASSIS				MOUNTING STYLES		SPACING	SERIES	PAGE
in.	mm.	Part Thread Length		Mounting Hole Diameter		PCB End	Chassis End			
For PCB's up to .062" (1,6 mm) Thick										
.098	2,5	.250	6,4		M3	teardrop snap lock	male thread M3	Imperial	HMSCBST-M3	Consult Heyco
					M4	teardrop snap lock	male thread M4		HMSCBST-M4	
.125	3,2	.250	6,4		M3	bayonet snap lock 8,7	male thread M3	Imperial	HSCBS3	7-23
					M4	bayonet snap lock 8,7	male thread M4		HSCBS4	
				6-32		bayonet snap lock 8,7	male thread 6-32		HSCBS5	
.152	3,9	.236	6,0		M3	two prong snap fit	male thread M3	Imperial	HSCBS1-M3	7-25
					M4	two prong snap fit	male thread M4		HSCBS1-M4	
				6-32		two prong snap fit	male thread 6-32		HSCBS1-632	
.157	4,0	.250	6,4		M4	bayonet snap lock 10,2	male thread M4	Imperial	HSCBS	7-24
					8-32	bayonet snap lock 10,2	male thread 8-32		HSCBS8	
		.300	7,6		M4	bayonet snap lock 10,2	male thread M4	Imperial	HSCBS7	7-24
				6-32		bayonet snap lock 10,2	male thread 6-32		HSCBS6	
6-32		.300	7,6	6-32		double threaded male - .30" (7,6 mm) thread length	Imperial	HCBS-TMM	7-25	

Adhesive-Back Mount Supports

PCB Mounting Hole Diameter		CHASSIS				MOUNTING STYLES		SPACING	SERIES	PAGE
in.	mm.	Maximum Thickness		Mounting Hole Diameter		PCB End	Chassis End			
.000	0,0	.00	0,0	.00	0,0	flat rest mount	adhesive-back 12,7 sq	Imperial	HPSBM	Consult Heyco
							adhesive-back 17,8 sq			
.098	2,5	.00	0,0	.00	0,0	teardrop snap lock	adhesive-back 12,7 sq	Imperial	HCBS4	7-26
.125	3,2	.00	0,0	.00	0,0	bayonet snap lock 8,7	adhesive-back 12,7 sq	Imperial	HCBS3	7-26
.157	4,0	.00	0,0	.00	0,0	bayonet snap lock 10,2	adhesive-back 17,8 sq	Imperial	HCBS	7-26
							Metric		HCBS-Metric	
						bayonet snap fit 10,2	adhesive-back 17,8 sq	Imperial	HCBS2	7-26

Rivet Mount and Edge Holding Supports

PCB Mounting Hole Diameter		CHASSIS				MOUNTING STYLES		SPACING	SERIES	PAGE
in.	mm.	Maximum Thickness		Mounting Hole Diameter		PCB End	Chassis End			
Rivet Mount - For PCB's .062" (1,6 mm) thick										
.157	4,0	varies †		.165	4,2	bayonet snap lock 10,2	rivet	Imperial	HRLSP	7-28
Rivet Mount - For PCB's .078" (2,0 mm) thick										
.187	4,8	varies †		.165	4,2	arrowhead snap lock	rivet	Imperial	HSRLAHS	7-28
Edge Holding - For PCB's .062" (1,6 mm) thick										
.157	4,0	varies ††		6-32		edge snap lock	self-tap screw #6	Imperial	HTEHCBS	7-29
		.062	1,6	schematic		edge snap lock	reverse rectangular	Imperial	HRLHCBS	
		.078	2,0	.187	4,8	edge snap lock	arrowhead snap lock	Imperial	HEHCBS-7	

†For Panel Thicknesses see Rivet Table on page 7-28. ††Varies with length of screw.

Threaded Hex Supports and Spacers

ALL NEW PRODUCT!

Nylon Male/Female Threaded Hex Supports	male thread	female thread	Both	MFS, MFSM	7-30
Nylon Tapped Hex Spacers	female thread	female thread	Both	HST, HSTM	7-31

Heyco® Nylon PCB Supports - Imperial Spacing

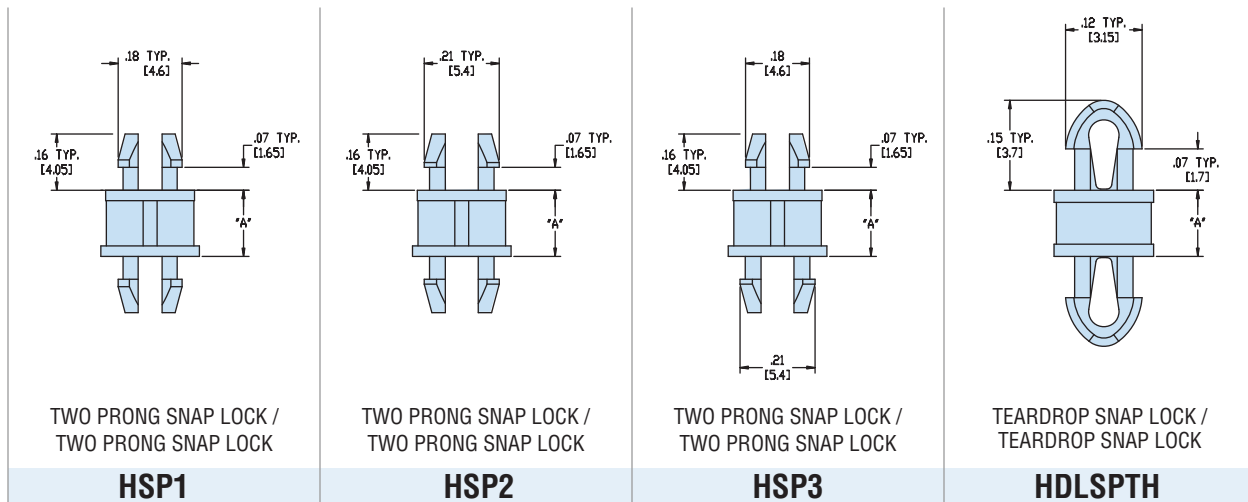

	Maximum Thickness		Mounting Hole Diameter		Maximum Thickness		Mounting Hole Diameter		Maximum Thickness		Mounting Hole Diameter		Maximum Thickness		Mounting Hole Diameter	
	in.	mm.	in.	mm.	in.	mm.	in.	mm.	in.	mm.	in.	mm.	in.	mm.	in.	mm.
PCB	.062	1,6	.157	4,0	.062	1,6	.187	4,8	.062	1,6	.157	4,0	.062	1,6	.098	2,5
Chassis	.062	1,6	.157	4,0	.062	1,6	.187	4,8	.062	1,6	.187	4,8	.062	1,6	.098	2,5

A		PART NO.	DESCRIPTION	PART NO.	DESCRIPTION	PART NO.	DESCRIPTION	PART NO.	DESCRIPTION
in.	mm.	Natural		Natural		Natural		Natural	
.063	1,6							10036	HDLSPTH-01
.125	3,2							10037	HDLSPTH-02
.187	4,8	10000	HSP1-03	10012	HSP2-03	10024	HSP3-03	10038	HDLSPTH-03
.250	6,4	10001	HSP1-04	10013	HSP2-04	10025	HSP3-04	10039	HDLSPTH-04
.312	7,9	10002	HSP1-05	10014	HSP2-05	10026	HSP3-05	10040	HDLSPTH-05
.375	9,5	10003	HSP1-06	10015	HSP2-06	10027	HSP3-06	10041	HDLSPTH-06
.437	11,1	10004	HSP1-07	10016	HSP2-07	10028	HSP3-07	10042	HDLSPTH-07
.500	12,7	10005	HSP1-08	10017	HSP2-08	10029	HSP3-08	10043	HDLSPTH-08
.562	14,3	10006	HSP1-09	10018	HSP2-09	10030	HSP3-09	10044	HDLSPTH-09
.625	15,9	10007	HSP1-10	10019	HSP2-10	10031	HSP3-10	10045	HDLSPTH-10
.750	19,1	10008	HSP1-12	10020	HSP2-12	10032	HSP3-12		
.875	22,2	10009	HSP1-14	10021	HSP2-14	10033	HSP3-14	10046	HDLSPTH-14
1.000	25,4	10010	HSP1-16	10022	HSP2-16	10034	HSP3-16		

Standard color natural. For special order parts in UL 94V-0 natural material, add the suffix "F" to Part No.

Quick Specs

Material: Nylon 6/6
 Flammability Rating: 94V-2
 Temperature Range: -40°F (-40°C) to 185°F (85°C)

Heyco® Nylon PCB Supports - Imperial Spacing

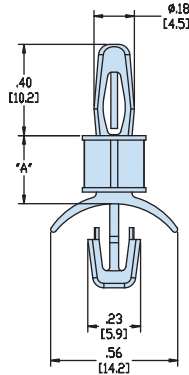

BAYONET SNAP LOCK 10,2 /
ARROWHEAD SNAP LOCK

HLSP1

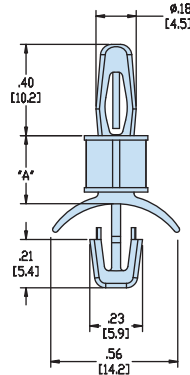

BAYONET SNAP LOCK 10,2 /
ARROWHEAD SNAP LOCK

HLSP2

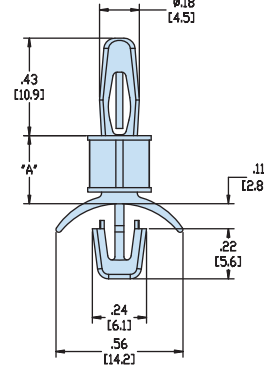

BAYONET SNAP LOCK 10,9 /
ARROWHEAD SNAP LOCK

HLSP3

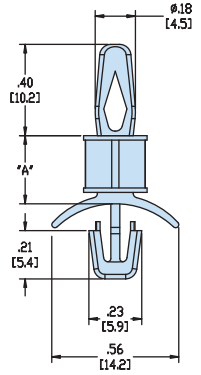

BAYONET SNAP FIT 10,2 /
ARROWHEAD SNAP LOCK

HLSP4

	Maximum Thickness		Mounting Hole Diameter		Maximum Thickness		Mounting Hole Diameter		Maximum Thickness		Mounting Hole Diameter		Maximum Thickness		Mounting Hole Diameter	
	in.	mm.	in.	mm.	in.	mm.	in.	mm.	in.	mm.	in.	mm.	in.	mm.	in.	mm.
PCB	.062	1,6	.157	4,0	.062	1,6	.157	4,0	.090	2,3	.157	4,0	.062	1,6	.157	4,0
Chassis	.078	2,0	.187	4,8	.141	3,6	.187	4,8	.078	2,0	.187	4,8	.078	2,0	.187	4,8

A		PART NO. Natural	DESCRIPTION	PART NO. Natural	DESCRIPTION	PART NO. Natural	DESCRIPTION	PART NO. Natural*	DESCRIPTION
in.	mm.								
.187	4,8	10048	HLSP1-03	10062	HLSP2-03	10076	HLSP3-03	10090	HLSP4-03
.250	6,4	10049	HLSP1-04	10063	HLSP2-04	10077	HLSP3-04	10091	HLSP4-04
.312	7,9	10050	HLSP1-05	10064	HLSP2-05	10078	HLSP3-05	10092	HLSP4-05
.375	9,5	10051	HLSP1-06	10065	HLSP2-06	10079	HLSP3-06	10093	HLSP4-06
.437	11,1	10052	HLSP1-07	10066	HLSP2-07	10080	HLSP3-07	10094	HLSP4-07
.500	12,7	10053	HLSP1-08	10067	HLSP2-08	10081	HLSP3-08	10095	HLSP4-08
.625	15,9	10054	HLSP1-10	10068	HLSP2-10	10082	HLSP3-10	10096	HLSP4-10
.750	19,1	10055	HLSP1-12	10069	HLSP2-12	10083	HLSP3-12	10097	HLSP4-12
.875	22,2	10056	HLSP1-14	10070	HLSP2-14	10084	HLSP3-14	10098	HLSP4-14
1.000	25,4	10057	HLSP1-16	10071	HLSP2-16	10085	HLSP3-16	10099	HLSP4-16
1.125	28,6	10058	HLSP1-18	10072	HLSP2-18	10086	HLSP3-18	10100	HLSP4-18
1.250	31,8	10059	HLSP1-20	10073	HLSP2-20	10087	HLSP3-20	10101	HLSP4-20
1.375	34,9	10060	HLSP1-22	10074	HLSP2-22	10088	HLSP3-22	10102	HLSP4-22

Standard color natural. For special order parts in UL 94V-0 natural material, add the suffix “F” to Part No.

*Consult Heyco for HLSP4 in V-0 material.



*Quick
Specs*

Material: Nylon 6/6
 Flammability Rating: 94V-2
 Temperature Range: -40°F (-40°C) to 185°F (85°C)

Heyco® Nylon PCB Supports - Imperial Spacing

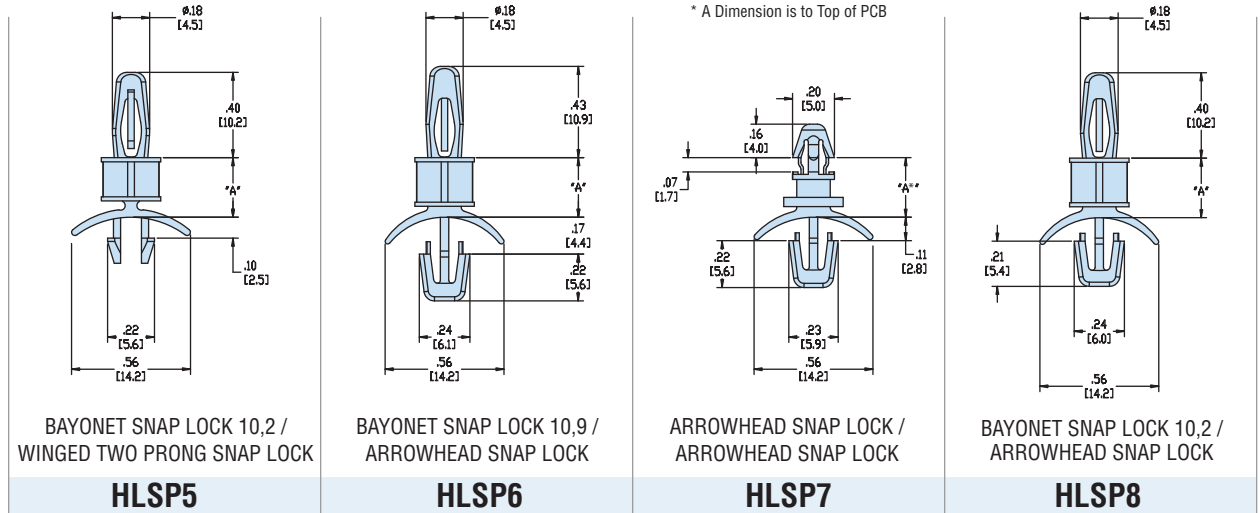

	Maximum Thickness		Mounting Hole Diameter		Maximum Thickness		Mounting Hole Diameter		Maximum Thickness		Mounting Hole Diameter		Maximum Thickness		Mounting Hole Diameter	
	in.	mm.	in.	mm.	in.	mm.	in.	mm.	in.	mm.	in.	mm.	in.	mm.	in.	mm.
PCB	.062	1,6	.157	4,0	.090	2,3	.157	4,0	.062	1,6	.157	4,0	.062	1,6	.157	4,0
Chassis	.078	2,0	.187	4,8	.141	3,6	.187	4,8	.078	2,0	.187	4,8	.055	1,4	.187	4,8

A		PART NO. Natural*	DESCRIPTION	PART NO. Natural*	DESCRIPTION	PART NO. Natural	DESCRIPTION	PART NO. Natural	DESCRIPTION
in.	mm.								
.187	4,8	10104	HLSP5-03	10118	HLSP6-03	10132	HLSP7-03	10146	HLSP8-03
.250	6,4	10105	HLSP5-04	10119	HLSP6-04	10133	HLSP7-04	10147	HLSP8-04
.312	7,9	10106	HLSP5-05	10120	HLSP6-05	10134	HLSP7-05	10148	HLSP8-05
.375	9,5	10107	HLSP5-06	10121	HLSP6-06	10135	HLSP7-06	10149	HLSP8-06
.437	11,1	10108	HLSP5-07	10122	HLSP6-07	10136	HLSP7-07	10150	HLSP8-07
.500	12,7	10109	HLSP5-08	10123	HLSP6-08	10137	HLSP7-08	10151	HLSP8-08
.625	15,9	10110	HLSP5-10	10124	HLSP6-10	10138	HLSP7-10	10152	HLSP8-10
.750	19,1	10111	HLSP5-12	10125	HLSP6-12	10139	HLSP7-12	10153	HLSP8-12
.875	22,2	10112	HLSP5-14	10126	HLSP6-14	10140	HLSP7-14	10154	HLSP8-14
1.000	25,4	10113	HLSP5-16	10127	HLSP6-16	10141	HLSP7-16	10155	HLSP8-16
1.125	28,6	10114	HLSP5-18	10128	HLSP6-18	10142	HLSP7-18	10156	HLSP8-18
1.250	31,8	10115	HLSP5-20	10129	HLSP6-20	10143	HLSP7-20	10157	HLSP8-20
1.375	34,9	10116	HLSP5-22	10130	HLSP6-22	10144	HLSP7-22	10158	HLSP8-22

Standard color natural. For special order parts in UL 94V-0 natural material, add the suffix "F" to Part No.

*Consult Heyco for HLSP5 & HLSP6 in V-0 material.



Quick
Specs

Material Nylon 6/6
 Flammability Rating 94V-2
 Temperature Range -40°F (-40°C) to 185°F (85°C)

“Stay Connected” with



HEYware

a PennEngineering® Company

Heyco® Nylon PCB Supports - Imperial Spacing

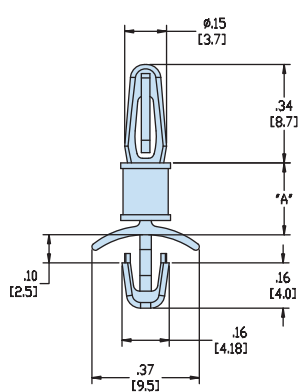

BAYONET SNAP LOCK 8,7 /
ARROWHEAD SNAP LOCK

HLSP9

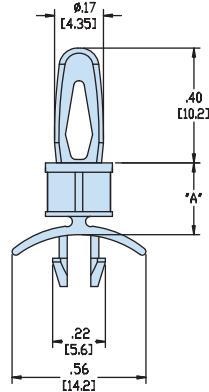

BAYONET SNAP FIT 10,2 /
WINGED TWO PRONG SNAP LOCK

HLSP10

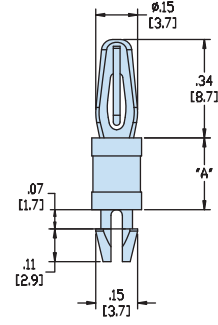

BAYONET SNAP LOCK 8,7 /
TWO PRONG SNAP LOCK

HLSP11

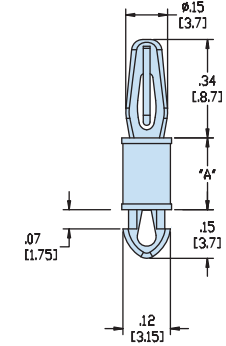

BAYONET SNAP LOCK 8,7 /
TEARDROP SNAP LOCK

HTLSP

	Maximum Thickness		Mounting Hole Diameter		Maximum Thickness		Mounting Hole Diameter		Maximum Thickness		Mounting Hole Diameter		Maximum Thickness		Mounting Hole Diameter	
	in.	mm.	in.	mm.	in.	mm.	in.	mm.	in.	mm.	in.	mm.	in.	mm.	in.	mm.
PCB	.062	1,6	.125	3,2	.062	1,6	.157	4,0	.062	1,6	.125	3,2	.062	1,6	.098	2,5
Chassis	.078	2,0	.125	3,2	.078	2,0	.187	4,8	.062	1,6	.125	3,2	.062	1,6	.125	3,2

A		PART NO. Natural	DESCRIPTION	PART NO. Natural	DESCRIPTION	PART NO. Natural	DESCRIPTION	PART NO. Natural	DESCRIPTION
in.	mm.								
.125	3,2	10160	HLSP9-02			10178	HLSP11-02	10190	HTLSP-02
.187	4,8	10161	HLSP9-03	10170	HLSP10-03	10179	HLSP11-03	10191	HTLSP-03
.250	6,4	10162	HLSP9-04	10171	HLSP10-04	10180	HLSP11-04	10192	HTLSP-04
.312	7,9	10163	HLSP9-05			10181	HLSP11-05	10193	HTLSP-05
.375	9,5	10164	HLSP9-06	10172	HLSP10-06	10182	HLSP11-06	10194	HTLSP-06
.437	11,1	10165	HLSP9-07			10183	HLSP11-07	10195	HTLSP-07
.500	12,7	10166	HLSP9-08	10173	HLSP10-08	10184	HLSP11-08	10196	HTLSP-08
.562	14,3	10167	HLSP9-09			10185	HLSP11-09		
.625	15,9	10168	HLSP9-10	10174	HLSP10-10	10186	HLSP11-10	10197	HTLSP-10
.750	19,1			10175	HLSP10-12	10187	HLSP11-12		
.875	22,2			10176	HLSP10-14	10188	HLSP11-14		

Standard color natural. For special order parts in UL 94V-0 natural material, add the suffix "F" to Part No.

Material: Nylon 6/6
 Flammability Rating: 94V-2
 Temperature Range: -40°F (-40°C) to 185°F (85°C)

*Quick
Specs*

Heyco® Nylon PCB Supports - Imperial Spacing

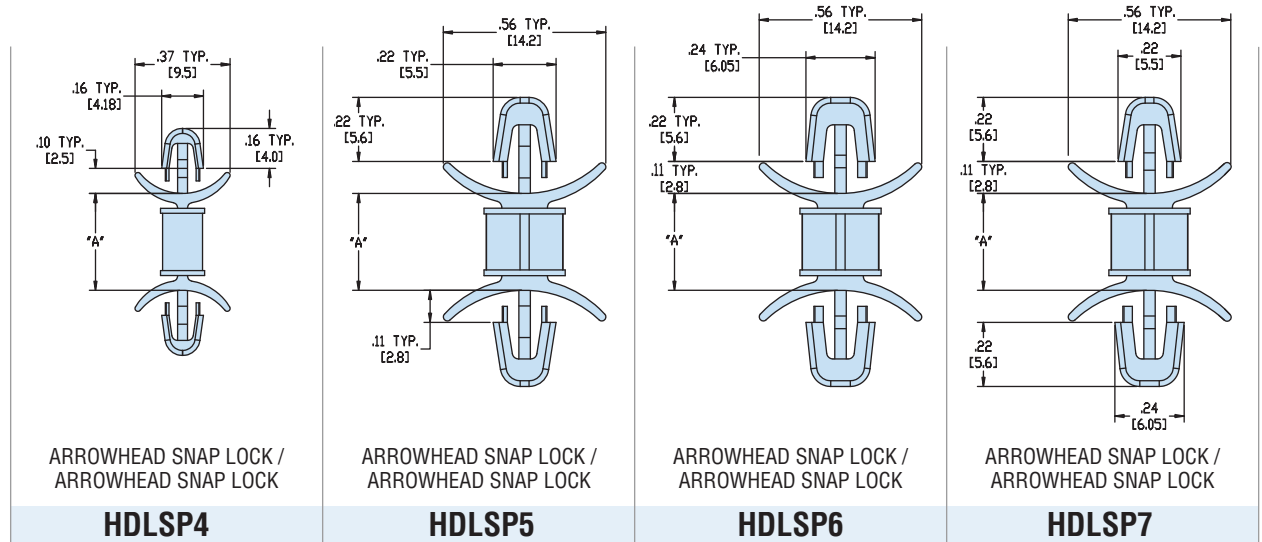

ARROWHEAD SNAP LOCK /
ARROWHEAD SNAP LOCK

ARROWHEAD SNAP LOCK /
ARROWHEAD SNAP LOCK

ARROWHEAD SNAP LOCK /
ARROWHEAD SNAP LOCK

ARROWHEAD SNAP LOCK /
ARROWHEAD SNAP LOCK

HDLSP4

HDLSP5

HDLSP6

HDLSP7

	Maximum Thickness		Mounting Hole Diameter		Maximum Thickness		Mounting Hole Diameter		Maximum Thickness		Mounting Hole Diameter		Maximum Thickness		Mounting Hole Diameter	
	in.	mm.	in.	mm.	in.	mm.	in.	mm.	in.	mm.	in.	mm.	in.	mm.	in.	mm.
PCB	.078	2,0	.125	3,2	.078	2,0	.157	4,0	.078	2,0	.187	4,8	.078	2,0	.157	4,0
Chassis	.078	2,0	.125	3,2	.078	2,0	.157	4,0	.078	2,0	.187	4,8	.078	2,0	.187	4,8

A		PART NO. Natural	DESCRIPTION	PART NO. Natural	DESCRIPTION	PART NO. Natural	DESCRIPTION	PART NO. Natural	DESCRIPTION
in.	mm.								
.187	4,8	10199	HDLSP4-03	10209	HDLSP5-03	10217	HDLSP6-03	10225	HDLSP7-03
.250	6,4	10200	HDLSP4-04	10210	HDLSP5-04	10218	HDLSP6-04	10226	HDLSP7-04
.312	7,9	10201	HDLSP4-05						
.375	9,5	10202	HDLSP4-06	10211	HDLSP5-06	10219	HDLSP6-06	10227	HDLSP7-06
.437	11,1	10203	HDLSP4-07	10216	HDLSP5-07				
.500	12,7	10204	HDLSP4-08	10212	HDLSP5-08	10220	HDLSP6-08	10228	HDLSP7-08
.562	14,3	10205	HDLSP4-09						
.625	15,9	10206	HDLSP4-10	10213	HDLSP5-10	10221	HDLSP6-10	10229	HDLSP7-10
.750	19,1			10214	HDLSP5-12	10222	HDLSP6-12	10230	HDLSP7-12
.875	22,2	10207	HDLSP4-14	10215	HDLSP5-14	10223	HDLSP6-14	10231	HDLSP7-14

NEW!

Standard color natural. For special order parts in UL 94V-0 natural material, add the suffix "F" to Part No.

*Quick
Specs*

Material Nylon 6/6
Flammability Rating 94V-2
Temperature Range -40°F (-40°C) to 185°F (85°C)

“Stay Connected” with



HEYware

a PennEngineering® Company

Heyco® Nylon PCB Supports - Imperial Spacing

ALL NEW PRODUCT!

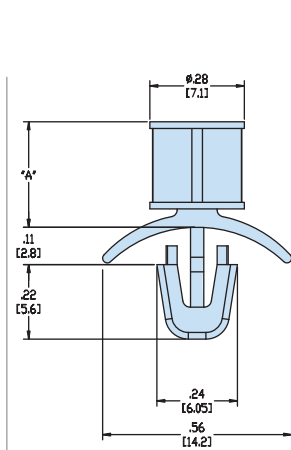

FLAT TOP REST MOUNT /
ARROWHEAD LOCK

HPS

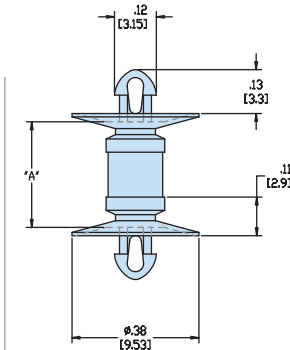

CUPPED TEARDROP /
CUPPED TEARDROP

HCDLCBST

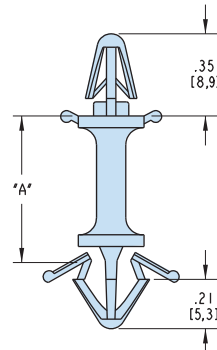

ARROWHEAD SNAP LOCK /
ARROWHEAD SNAP LOCK

HSSL

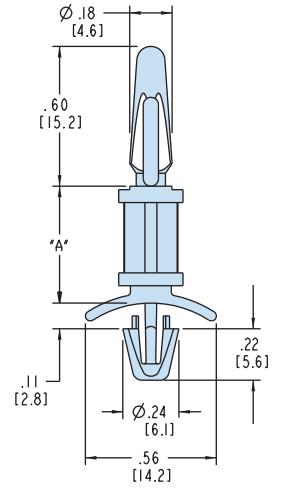

BAYONET SNAP LOCK 15.2 /
ARROWHEAD SNAP LOCK

HLNCBS

	Maximum Thickness		Mounting Hole Diameter		Maximum Thickness		Mounting Hole Diameter		Maximum Thickness		Mounting Hole Diameter	
	in.	mm.	in.	mm.	in.	mm.	in.	mm.	in.	mm.	in.	mm.
PCB	flat top rest mount				.062	1,6	.098	2,5	.062	1,6	.157	4,0
Chassis	.078	2,0	.187	4,8	.062	1,6	.098	2,5	.070	1,8	.188	4,8

A	PART NO.	DESCRIPTION	PART NO.	DESCRIPTION	PART NO.	DESCRIPTION	PART NO.	DESCRIPTION	
									in.
.187	4,8	10233	HPS-03	10836	HCDLCBST-03	3670	HSSL-03	10966	HLNCBS-03
.250	6,4	10234	HPS-04	10837	HCDLCBST-04	3671	HSSL-04	10967	HLNCBS-04
.312	7,9	10235	HPS-05	10838	HCDLCBST-05				
.375	9,5	10236	HPS-06	10839	HCDLCBST-06	3672	HSSL-06	10969	HLNCBS-06
.437	11,1	10237	HPS-07	10840	HCDLCBST-07	3673	HSSL-07		
.500	12,7	10238	HPS-08	10841	HCDLCBST-08	3674	HSSL-08	10971	HLNCBS-08
.562	14,3			10842	HCDLCBST-09				
.625	15,9	10239	HPS-10	10843	HCDLCBST-10	3675	HSSL-10	10973	HLNCBS-10
.750	19,1	10240	HPS-12			3676	HSSL-12	10974	HLNCBS-12
.875	22,2	10241	HPS-14					10975	HLNCBS-14

Standard color natural. For special order parts in UL 94V-0 natural material, add the suffix “F” to Part No.

*Consult Heyco for HCDLCBST in V-0 material.

Material: Nylon 6/6
 Flammability Rating: 94V-2
 Temperature Range: -40°F (-40°C) to 185°F (85°C)

Quick Specs

“Stay Connected” with



HEYware

a PennEngineering® Company

Heyco® Nylon PCB Supports - Imperial Spacing

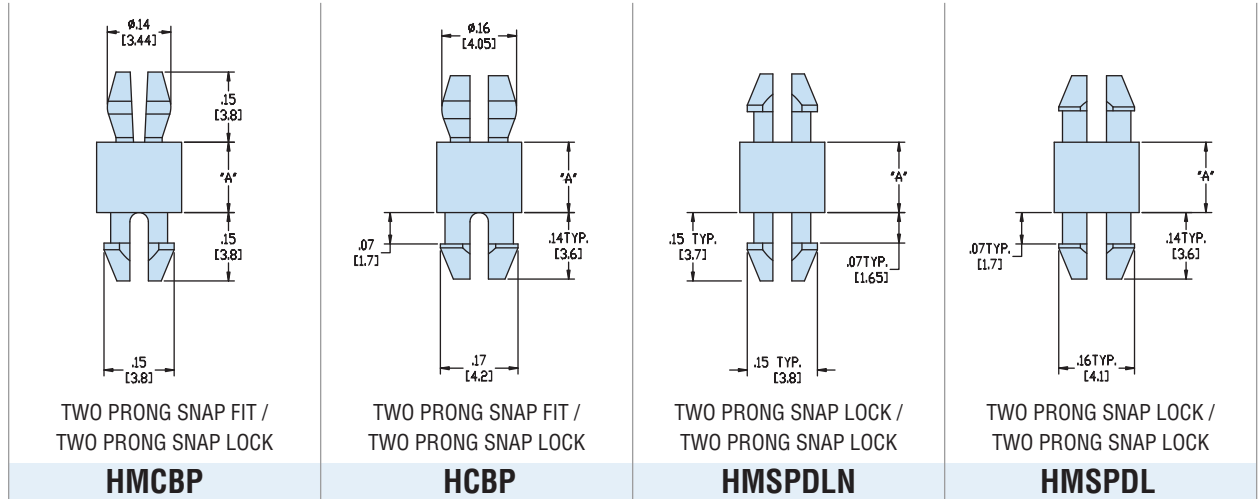

	Maximum Thickness		Mounting Hole Diameter		Maximum Thickness		Mounting Hole Diameter		Maximum Thickness		Mounting Hole Diameter		Maximum Thickness		Mounting Hole Diameter	
	in.	mm.	in.	mm.	in.	mm.	in.	mm.	in.	mm.	in.	mm.	in.	mm.	in.	mm.
PCB	.062	1,6	.125	3,2	.062	1,6	.153	3,9	.062	1,6	.125	3,2	.062	1,6	.153	3,9
Chassis	.062	1,6	.125	3,2	.062	1,6	.153	3,9	.062	1,6	.125	3,2	.062	1,6	.153	3,9

A		PART NO. Natural	DESCRIPTION	PART NO. Natural	DESCRIPTION	PART NO. Natural	DESCRIPTION	PART NO. Natural	DESCRIPTION
in.	mm.								
.063	1,6	10243	HMCBP-01						
.125	3,2	10244	HMCBP-02	10263	HCBP-02	10282	HMSPDLN-02	10301	HMSPDL-02
.187	4,8	10245	HMCBP-03	10264	HCBP-03	10283	HMSPDLN-03	10302	HMSPDL-03
.250	6,4	10246	HMCBP-04	10265	HCBP-04	10284	HMSPDLN-04	10303	HMSPDL-04
.312	7,9	10247	HMCBP-05	10266	HCBP-05	10285	HMSPDLN-05	10304	HMSPDL-05
.375	9,5	10248	HMCBP-06	10267	HCBP-06	10286	HMSPDLN-06	10305	HMSPDL-06
.437	11,1	10249	HMCBP-07	10268	HCBP-07	10287	HMSPDLN-07	10306	HMSPDL-07
.500	12,7	10250	HMCBP-08	10269	HCBP-08	10288	HMSPDLN-08	10307	HMSPDL-08
.562	14,3	10251	HMCBP-09	10270	HCBP-09	10289	HMSPDLN-09	10308	HMSPDL-09
.625	15,9	10252	HMCBP-10	10271	HCBP-10	10290	HMSPDLN-10	10309	HMSPDL-10
.689	17,5	10253	HMCBP-11	10272	HCBP-11	10291	HMSPDLN-11	10310	HMSPDL-11
.750	19,1	10254	HMCBP-12	10273	HCBP-12	10292	HMSPDLN-12	10311	HMSPDL-12
.811	20,6	10255	HMCBP-13	10274	HCBP-13	10293	HMSPDLN-13	10312	HMSPDL-13
.875	22,2	10256	HMCBP-14	10275	HCBP-14	10294	HMSPDLN-14	10313	HMSPDL-14
1.000	25,4	10257	HMCBP-16	10276	HCBP-16	10295	HMSPDLN-16	10314	HMSPDL-16
1.125	28,6	10258	HMCBP-18	10277	HCBP-18	10296	HMSPDLN-18	10315	HMSPDL-18
1.250	31,8	10259	HMCBP-20	10278	HCBP-20	10297	HMSPDLN-20	10316	HMSPDL-20
1.375	34,9	10260	HMCBP-22	10279	HCBP-22	10298	HMSPDLN-22	10317	HMSPDL-22
1.500	38,1	10261	HMCBP-24	10280	HCBP-24	10299	HMSPDLN-24	10318	HMSPDL-24

Standard color natural. For special order parts in UL 94V-0 natural material, add the suffix “F” to Part No.

Quick
Specs

Material Nylon 6/6
 Flammability Rating 94V-2
 Temperature Range -40°F (-40°C) to 185°F (85°C)

Heyco® Nylon PCB Supports - Imperial Spacing

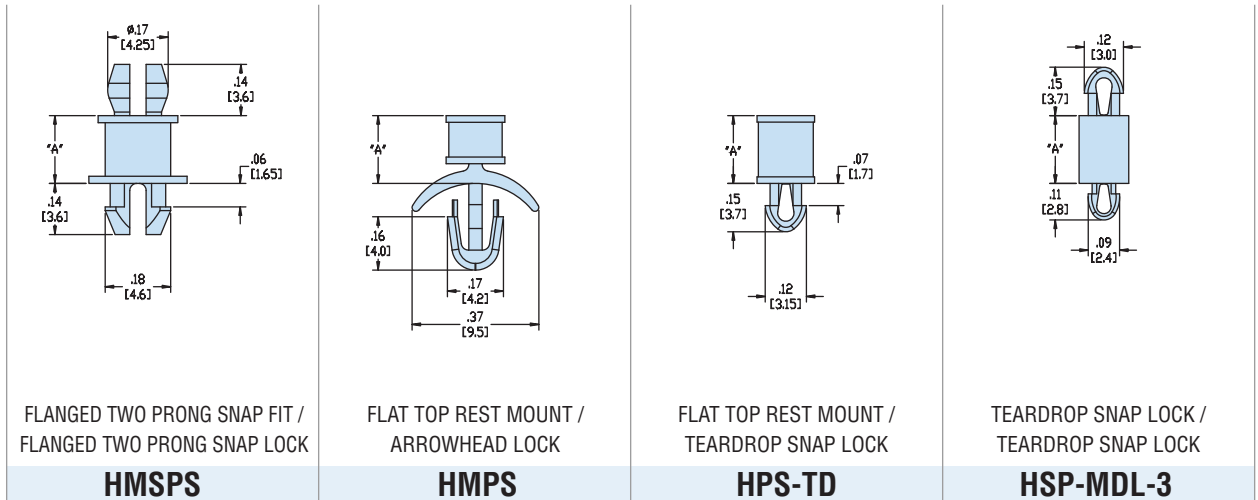

	Maximum Thickness		Mounting Hole Diameter		Maximum Thickness		Mounting Hole Diameter		Maximum Thickness		Mounting Hole Diameter		Maximum Thickness		Mounting Hole Diameter	
	in.	mm.	in.	mm.	in.	mm.	in.	mm.	in.	mm.	in.	mm.	in.	mm.	in.	mm.
PCB	.062	1,6	.157	4,0	flat top rest mount				flat top rest mount				.062	1,6	.098	2,5
Chassis	.062	1,6	.157	4,0	.078	2,0	.125	3,2	.062	1,6	.098	2,5	.039	1,0	.078	2,0

A		PART NO. Natural	DESCRIPTION	PART NO. Natural	DESCRIPTION	PART NO. Natural	DESCRIPTION	PART NO. Natural	DESCRIPTION
in.	mm.								
.063	1,6					10341	HPS-TD-01	10352	HSP-MDL-3-01
.125	3,2			10331	HMPS-02	10342	HPS-TD-02	10353	HSP-MDL-3-02
.187	4,8	10320	HMSPS-03	10332	HMPS-03	10343	HPS-TD-03	10354	HSP-MDL-3-03
.250	6,4	10321	HMSPS-04	10333	HMPS-04	10344	HPS-TD-04	10355	HSP-MDL-3-04
.312	7,9	10322	HMSPS-05	10334	HMPS-05	10345	HPS-TD-05	10356	HSP-MDL-3-05
.375	9,5	10323	HMSPS-06	10335	HMPS-06	10346	HPS-TD-06	10357	HSP-MDL-3-06
.437	11,1	10324	HMSPS-07	10336	HMPS-07	10347	HPS-TD-07		
.500	12,7	10325	HMSPS-08	10337	HMPS-08	10348	HPS-TD-08		
.562	14,3			10338	HMPS-09	10349	HPS-TD-09		
.625	15,9	10326	HMSPS-10	10339	HMPS-10	10350	HPS-TD-10		
.689	17,5	10327	HMSPS-11						
.750	19,1	10328	HMSPS-12						
.875	22,2	10329	HMSPS-14						

Standard color natural. For special order parts in UL 94V-0 natural material, add the suffix "F" to Part No.

Material: Nylon 6/6
 Flammability Rating: 94V-2
 Temperature Range: -40°F (-40°C) to 185°F (85°C)

*Quick
Specs*

“Stay Connected” with



HEYware

a PennEngineering® Company

Heyco® Nylon PCB Supports - Metric Spacing

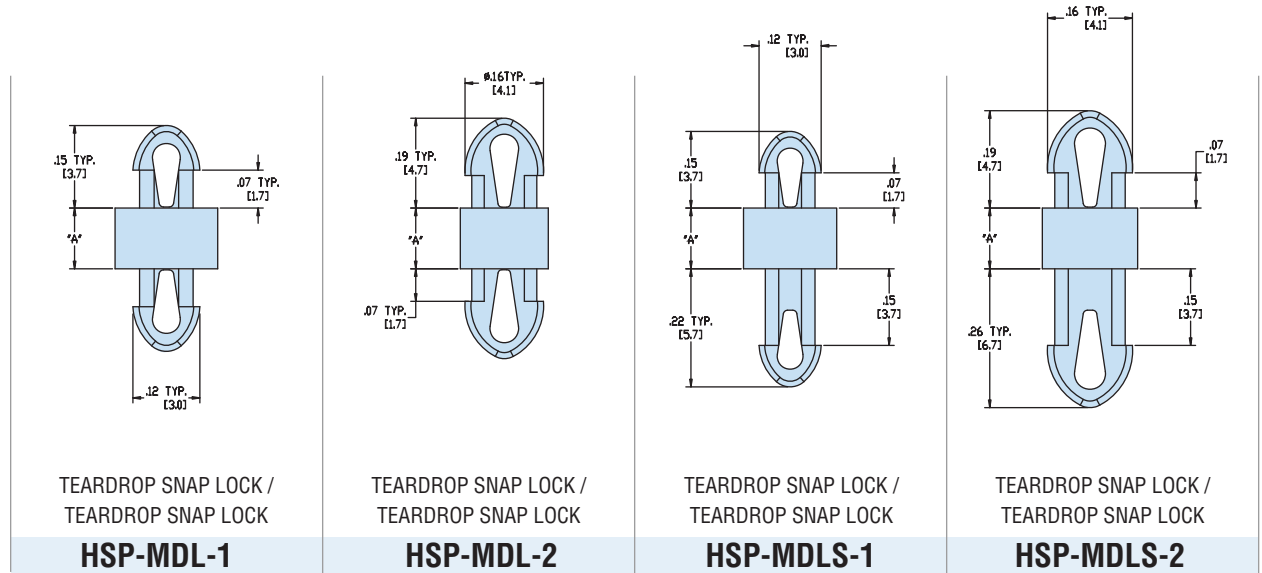

TEARDROP SNAP LOCK /
TEARDROP SNAP LOCK

HSP-MDL-1

TEARDROP SNAP LOCK /
TEARDROP SNAP LOCK

HSP-MDL-2

TEARDROP SNAP LOCK /
TEARDROP SNAP LOCK

HSP-MDLS-1

TEARDROP SNAP LOCK /
TEARDROP SNAP LOCK

HSP-MDLS-2

	Maximum Thickness		Mounting Hole Diameter		Maximum Thickness		Mounting Hole Diameter		Maximum Thickness		Mounting Hole Diameter		Maximum Thickness		Mounting Hole Diameter	
	in.	mm.	in.	mm.	in.	mm.	in.	mm.	in.	mm.	in.	mm.	in.	mm.	in.	mm.
PCB	.062	1,6	.098	2,5	.062	1,6	.137	3,5	.062	1,6	.098	2,5	.062	1,6	.137	3,5
Chassis	.062	1,6	.098	2,5	.062	1,6	.137	3,5	.141	3,6	.098	2,5	.141	3,6	.137	3,5

A mm.	PART NO. Natural	DESCRIPTION	PART NO. Natural	DESCRIPTION	PART NO. Natural	DESCRIPTION	PART NO. Natural	DESCRIPTION
2,0	10444	HSP-MDL-1-02M	10461	HSP-MDL-2-02M	10478	HSP-MDLS-1-02M	10493	HSP-MDLS-2-02M
3,0	10445	HSP-MDL-1-03M	10462	HSP-MDL-2-03M	10479	HSP-MDLS-1-03M	10494	HSP-MDLS-2-03M
4,0	10446	HSP-MDL-1-04M	10463	HSP-MDL-2-04M	10480	HSP-MDLS-1-04M	10495	HSP-MDLS-2-04M
5,0	10447	HSP-MDL-1-05M	10464	HSP-MDL-2-05M	10481	HSP-MDLS-1-05M	10496	HSP-MDLS-2-05M
6,0	10448	HSP-MDL-1-06M	10465	HSP-MDL-2-06M	10482	HSP-MDLS-1-06M	10497	HSP-MDLS-2-06M
7,0	10449	HSP-MDL-1-07M	10466	HSP-MDL-2-07M	10483	HSP-MDLS-1-07M	10498	HSP-MDLS-2-07M
8,0	10450	HSP-MDL-1-08M	10467	HSP-MDL-2-08M	10484	HSP-MDLS-1-08M	10499	HSP-MDLS-2-08M
9,0	10451	HSP-MDL-1-09M	10468	HSP-MDL-2-09M				
10,0	10452	HSP-MDL-1-10M	10469	HSP-MDL-2-10M	10485	HSP-MDLS-1-10M	10500	HSP-MDLS-2-10M
12,0	10453	HSP-MDL-1-12M	10470	HSP-MDL-2-12M	10486	HSP-MDLS-1-12M	10501	HSP-MDLS-2-12M
14,0	10454	HSP-MDL-1-14M	10471	HSP-MDL-2-14M	10487	HSP-MDLS-1-14M	10502	HSP-MDLS-2-14M
16,0	10455	HSP-MDL-1-16M	10472	HSP-MDL-2-16M	10488	HSP-MDLS-1-16M	10503	HSP-MDLS-2-16M
18,0	10456	HSP-MDL-1-18M	10473	HSP-MDL-2-18M	10489	HSP-MDLS-1-18M	10504	HSP-MDLS-2-18M
20,0	10457	HSP-MDL-1-20M	10474	HSP-MDL-2-20M	10490	HSP-MDLS-1-20M	10505	HSP-MDLS-2-20M
22,0	10458	HSP-MDL-1-22M	10475	HSP-MDL-2-22M	10491	HSP-MDLS-1-22M	10506	HSP-MDLS-2-22M
26,5	10459	HSP-MDL-1-26.5M	10476	HSP-MDL-2-26.5M				

Standard color natural. For special order parts in UL 94V-0 natural material, add the suffix “F” to Part No.

Quick
Specs

Material Nylon 6/6
Flammability Rating 94V-2
Temperature Range -40°F (-40°C) to 185°F (85°C)

“Stay Connected” with



HEYware

a PennEngineering® Company

Heyco® Nylon PCB Supports - Metric Spacing

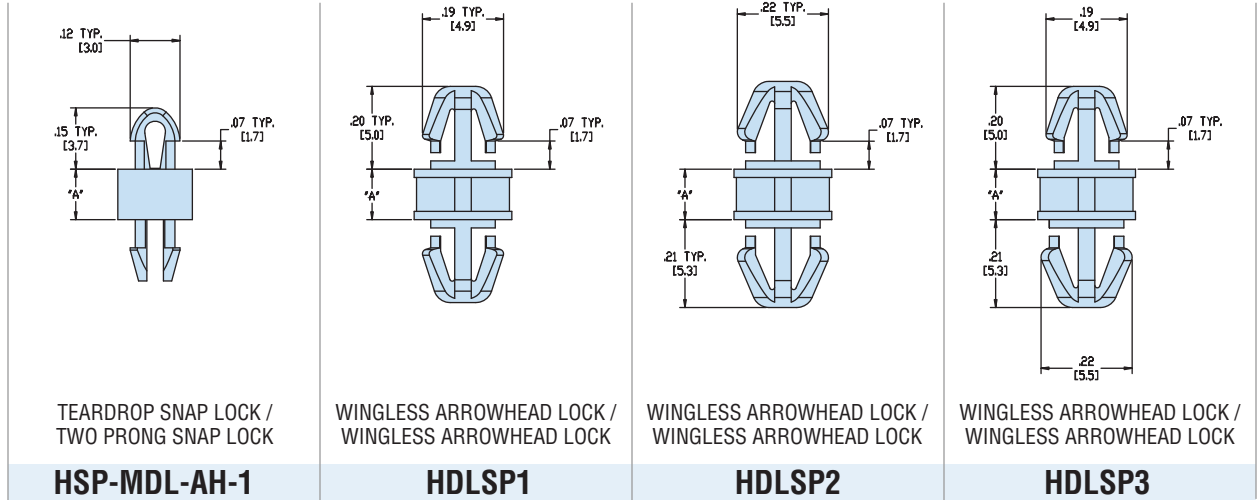

TEARDROP SNAP LOCK / TWO PRONG SNAP LOCK

HSP-MDL-AH-1

WINGLESS ARROWHEAD LOCK / WINGLESS ARROWHEAD LOCK

HDLSP1

WINGLESS ARROWHEAD LOCK / WINGLESS ARROWHEAD LOCK

HDLSP2

WINGLESS ARROWHEAD LOCK / WINGLESS ARROWHEAD LOCK

HDLSP3

	Maximum Thickness		Mounting Hole Diameter		Maximum Thickness		Mounting Hole Diameter		Maximum Thickness		Mounting Hole Diameter		Maximum Thickness		Mounting Hole Diameter	
	in.	mm.	in.	mm.	in.	mm.	in.	mm.	in.	mm.	in.	mm.	in.	mm.	in.	mm.
PCB	.062	1,6	.098	2,5	.062	1,6	.157	4,0	.062	1,6	.187	4,8	.062	1,6	.157	4,0
Chassis	.062	1,6	.098	2,5	.062	1,6	.157	4,0	.062	1,6	.187	4,8	.062	1,6	.187	4,8

A mm.	PART NO. Natural	DESCRIPTION	PART NO. Natural	DESCRIPTION	PART NO. Natural	DESCRIPTION	PART NO. Natural	DESCRIPTION
2,0	10508	HSP-MDL-AH-1-02M						
3,0	10509	HSP-MDL-AH-1-03M	10523	HDLSP1-03M	10533	HDLSP2-03M	10543	HDLSP3-03M
4,0	10510	HSP-MDL-AH-1-04M	10524	HDLSP1-04M	10534	HDLSP2-04M	10544	HDLSP3-04M
5,0	10511	HSP-MDL-AH-1-05M						
6,0	10512	HSP-MDL-AH-1-06M	10525	HDLSP1-06M	10535	HDLSP2-06M	10545	HDLSP3-06M
7,0	10513	HSP-MDL-AH-1-07M						
8,0	10514	HSP-MDL-AH-1-08M	10526	HDLSP1-08M	10536	HDLSP2-08M	10546	HDLSP3-08M
10,0	10515	HSP-MDL-AH-1-10M	10527	HDLSP1-10M	10537	HDLSP2-10M	10547	HDLSP3-10M
12,0	10516	HSP-MDL-AH-1-12M	10528	HDLSP1-12M	10538	HDLSP2-12M	10548	HDLSP3-12M
14,0	10517	HSP-MDL-AH-1-14M	10529	HDLSP1-14M	10539	HDLSP2-14M	10549	HDLSP3-14M
16,0	10518	HSP-MDL-AH-1-16M	10530	HDLSP1-16M	10540	HDLSP2-16M	10550	HDLSP3-16M
18,0	10519	HSP-MDL-AH-1-18M	10531	HDLSP1-18M	10541	HDLSP2-18M	10551	HDLSP3-18M
20,0	10520	HSP-MDL-AH-1-20M						
22,0	10521	HSP-MDL-AH-1-22M						

Standard color natural. For special order parts in UL 94V-0 natural material, add the suffix "F" to Part No.



Material: Nylon 6/6
 Flammability Rating: 94V-2
 Temperature Range: -40°F (-40°C) to 185°F (85°C)

Quick Specs

“Stay Connected” with



HEYware

a PennEngineering® Company

Heyco® Nylon PCB Supports - Reverse Locking

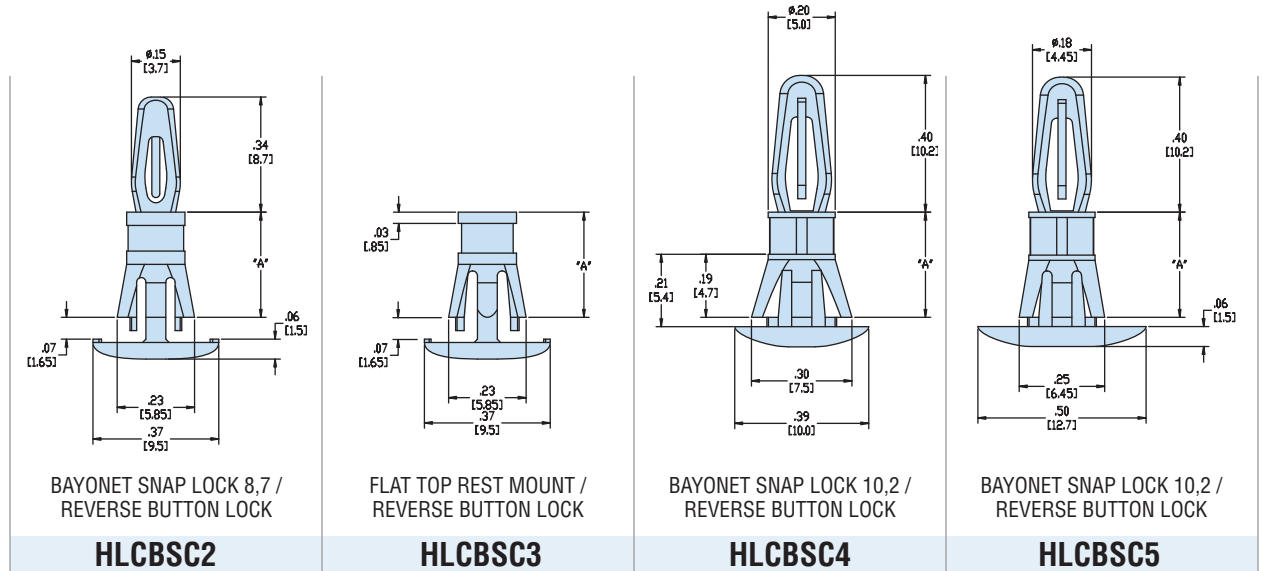

	Maximum Thickness		Mounting Hole Diameter		Maximum Thickness		Mounting Hole Diameter		Maximum Thickness		Mounting Hole Diameter		Maximum Thickness		Mounting Hole Diameter	
	in.	mm.	in.	mm.	in.	mm.	in.	mm.	in.	mm.	in.	mm.	in.	mm.	in.	mm.
PCB	.062	1,6	.125	3,2	flat top rest mount				.062	1,6	.157	4,0	.062	1,6	.157	4,0
Chassis	.062	1,6	.187	4,8	.062	1,6	.187	4,8	.047	1,2	.236	6,0	.078	2,0	.212	5,4

A		PART NO. Natural	DESCRIPTION	PART NO. Natural	DESCRIPTION	PART NO. Natural	DESCRIPTION	PART NO. Natural	DESCRIPTION
in.	mm.								
.187	4,8					10375	HLCBSC4-03		
.250	6,4	10359	HLCBSC2-04	10367	HLCBSC3-04	10376	HLCBSC4-04	10382	HLCBSC5-04
.312	7,9	10360	HLCBSC2-05	10368	HLCBSC3-05	10377	HLCBSC4-05		
.375	9,5	10361	HLCBSC2-06	10369	HLCBSC3-06	10378	HLCBSC4-06	10383	HLCBSC5-06
.437	11,1	10362	HLCBSC2-07	10370	HLCBSC3-07				
.500	12,7	10363	HLCBSC2-08	10371	HLCBSC3-08	10379	HLCBSC4-08	10384	HLCBSC5-08
.562	14,3	10364	HLCBSC2-09	10372	HLCBSC3-09				
.625	15,9	10365	HLCBSC2-10	10373	HLCBSC3-10	10381	HLCBSC4-10	10385	HLCBSC5-10
.750	19,1					10380	HLCBSC4-12		

Standard color natural. For special order parts in UL 94V-0 natural material, add the suffix “F” to Part No.

Quick
Specs

Material: Nylon 6/6
 Flammability Rating: 94V-2
 Temperature Range: -40°F (-40°C) to 185°F (85°C)

"Stay Connected" with



HEYware

a PennEngineering® Company

Heyco® Nylon PCB Supports - Reverse Locking

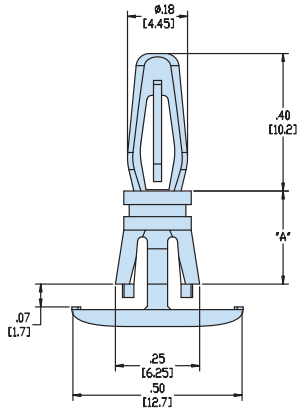

BAYONET SNAP LOCK 10,2 /
REVERSE BUTTON LOCK

HLCBSC6

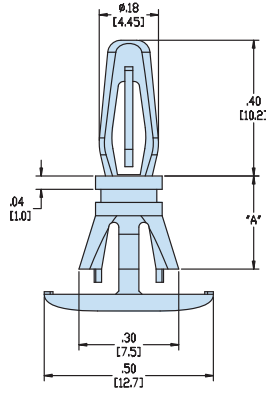

BAYONET SNAP LOCK 10,2 /
REVERSE BUTTON LOCK

HLCBSC7

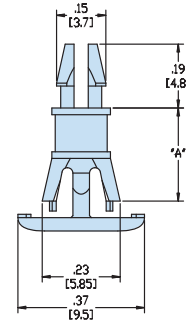

TWO PRONG SNAP LOCK /
REVERSE BUTTON LOCK

HLCBSC8

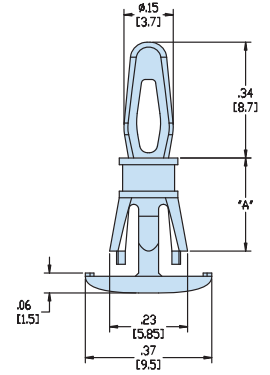

BAYONET SNAP FIT 8,7 /
REVERSE BUTTON LOCK

HLCBSC9

	Maximum Thickness		Mounting Hole Diameter		Maximum Thickness		Mounting Hole Diameter		Maximum Thickness		Mounting Hole Diameter		Maximum Thickness		Mounting Hole Diameter	
	in.	mm.	in.	mm.	in.	mm.	in.	mm.	in.	mm.	in.	mm.	in.	mm.	in.	mm.
PCB	.062	1,6	.157	4,0	.062	1,6	.157	4,0	.062	1,6	.125	3,2	.062	1,6	.125	3,2
Chassis	.065	1,7	.212	5,4	.065	1,7	.250	6,4	.062	1,6	.187	4,8	.062	1,6	.187	4,8

A	PART NO.	DESCRIPTION	PART NO.	DESCRIPTION	PART NO.	DESCRIPTION	PART NO.	DESCRIPTION	
									in.
.250	6,4	10387	HLCBSC6-04	10392	HLCBSC7-04	10397	HLCBSC8-04	10405	HLCBSC9-04
.312	7,9					10398	HLCBSC8-05	10406	HLCBSC9-05
.375	9,5	10388	HLCBSC6-06	10393	HLCBSC7-06	10399	HLCBSC8-06	10407	HLCBSC9-06
.437	11,1					10400	HLCBSC8-07	10408	HLCBSC9-07
.500	12,7	10389	HLCBSC6-08	10394	HLCBSC7-08	10401	HLCBSC8-08	10409	HLCBSC9-08
.562	14,3					10402	HLCBSC8-09	10410	HLCBSC9-09
.625	15,9	10390	HLCBSC6-10	10395	HLCBSC7-10	10403	HLCBSC8-10	10411	HLCBSC9-10

Standard color natural. For special order parts in UL 94V-0 natural material, add the suffix "F" to Part No.



Material	Nylon 6/6
Flammability Rating	94V-2
Temperature Range	-40°F (-40°C) to 185°F (85°C)

Quick
Specs

"Stay Connected" with



HEYware

a PennEngineering® Company

Heyco® Nylon PCB Supports - Reverse Locking

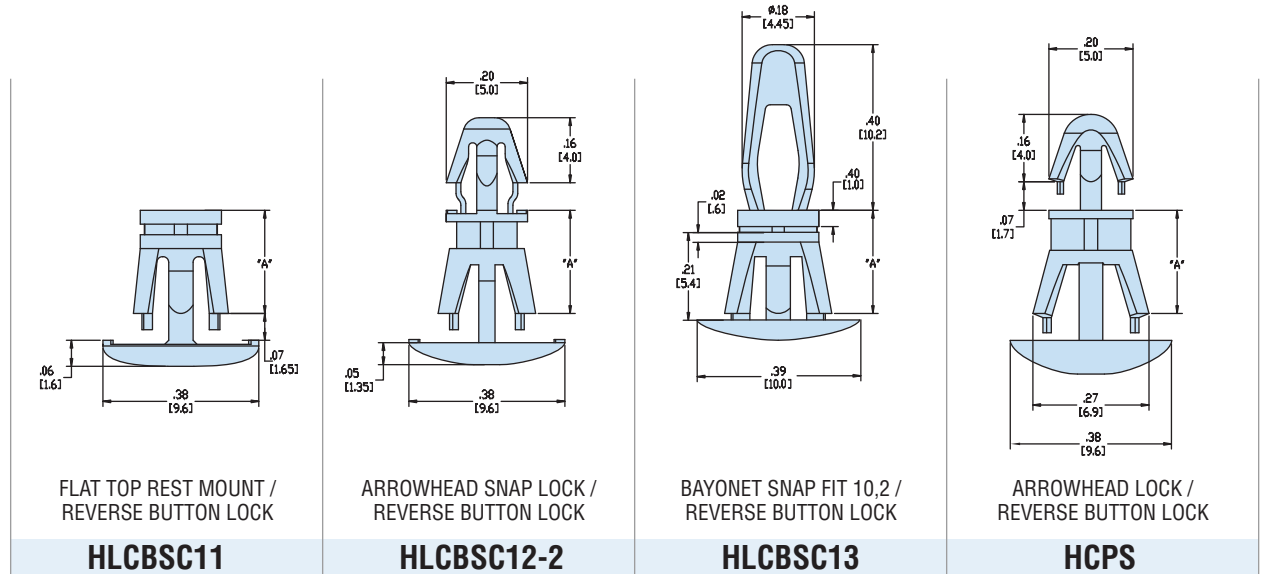

	Maximum Thickness		Mounting Hole Diameter		Maximum Thickness		Mounting Hole Diameter		Maximum Thickness		Mounting Hole Diameter		Maximum Thickness		Mounting Hole Diameter	
	in.	mm.	in.	mm.	in.	mm.	in.	mm.	in.	mm.	in.	mm.	in.	mm.	in.	mm.
PCB	flat top rest mount				.062	1,6	.157	4,0	.062	1,6	.157	4,0	.062	1,6	.157	4,0
Chassis	.062	1,6	.212	5,4	.078	2,0	.212	5,4	.047	1,2	.236	6,0	.062	1,6	.216	5,5

A	PART NO.		DESCRIPTION	PART NO.		DESCRIPTION	PART NO.		DESCRIPTION	PART NO.		DESCRIPTION
	in.	mm.		Natural*	Natural		Natural	Natural		Natural		
.187	4,8					10426	HLCBSC13-03					
.250	6,4					10427	HLCBSC13-04					
.312	7,9					10428	HLCBSC13-05	10845	HCPS-05			
.375	9,5	10413	HLCBSC11-06	10420	HLCBSC12-2-06	10429	HLCBSC13-06	10846	HCPS-06			
.488	12,4	10414	HLCBSC11-7.8									
.500	12,7	10415	HLCBSC11-08	10421	HLCBSC12-2-08	10430	HLCBSC13-08	10847	HCPS-08			
.625	15,9	10416	HLCBSC11-10	10422	HLCBSC12-2-10			10848	HCPS-10			
.750	19,1	10417	HLCBSC11-12	10423	HLCBSC12-2-12	10431	HLCBSC13-12	10849	HCPS-12			
.875	22,2	10418	HLCBSC11-14	10424	HLCBSC12-2-14			10850	HCPS-14			
1.000	25,4							10851	HCPS-16			
1.125	28,6							10852	HCPS-18			
1.250	31,8							10853	HCPS-20			
1.375	34,9							10854	HCPS-22			
1.500	38,1							10855	HCPS-24			

Standard color natural. For special order parts in UL 94V-0 natural material, add the suffix "F" to Part No.

*Consult Heyco for HLCBSC11 in V-0 material.

Quick Specs

Material: Nylon 6/6
 Flammability Rating: 94V-2
 Temperature Range: -40°F (-40°C) to 185°F (85°C)

“Stay Connected” with



HEYware

a PennEngineering® Company

Heyco® Nylon PCB Supports - Metric Reverse Locking

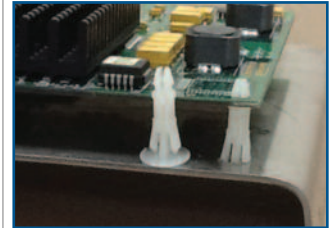
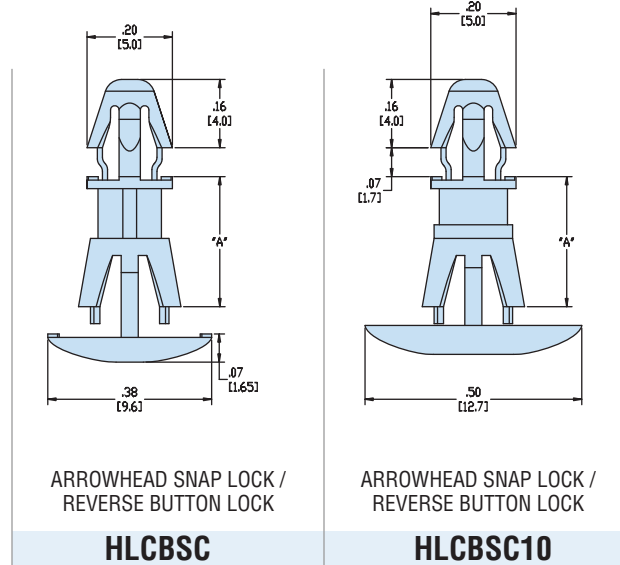

	Maximum Thickness		Mounting Hole Diameter		Maximum Thickness		Mounting Hole Diameter	
	in.	mm.	in.	mm.	in.	mm.	in.	mm.
PCB	.062	1,6	.157	4,0	.062	1,6	.157	4,0
Chassis	.062	1,6	.212	5,4	.062	1,6	.212	5,4

A mm.	PART NO. Natural	DESCRIPTION	PART NO. Natural	DESCRIPTION
6,0	10433	HLCBSC-06M		
8,0	10434	HLCBSC-08M	10439	HLCBSC10-08M
10,0	10435	HLCBSC-10M	10440	HLCBSC10-10M
12,0	10436	HLCBSC-12M	10441	HLCBSC10-12M
14,0	10437	HLCBSC-14M	10442	HLCBSC10-14M

Standard color natural. For special order parts in UL 94V-0 material, add the suffix “F” to Part No.

Material: Nylon 6/6
 Flammability Rating: 94V-2
 Temperature Range: -40°F (-40°C) to 185°F (85°C)

*Quick
Specs*

Heyco® Nylon PCB Supports - Blind Mount

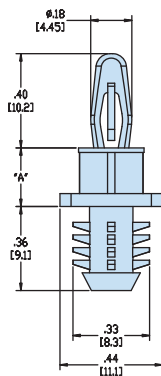

BAYONET SNAP LOCK 10,2 /
BLIND FIR TREE

HBS

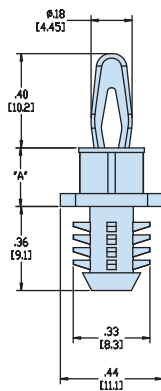

BAYONET SNAP FIT 10,2 /
BLIND FIR TREE

HBS2

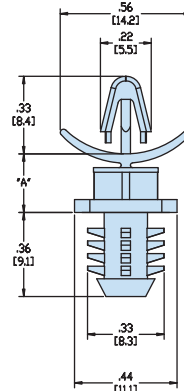

ARROWHEAD SNAP LOCK /
BLIND FIR TREE

HBS3

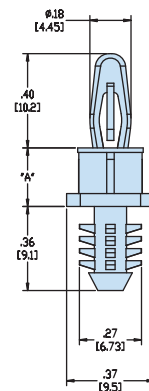

BAYONET SNAP LOCK 10,2 /
BLIND FIR TREE

HBS4

	Minimum Thickness		Mounting Hole Diameter		Minimum Thickness		Mounting Hole Diameter		Minimum Thickness		Mounting Hole Diameter		Minimum Thickness		Mounting Hole Diameter	
	in.	mm.	in.	mm.	in.	mm.	in.	mm.	in.	mm.	in.	mm.	in.	mm.	in.	mm.
PCB	.062	1,6	.157	4,0	.062	1,6	.157	4,0	.078	2,0	.157	4,0	.062	1,6	.157	4,0
Chassis	.250	6,4	.312	7,9	.250	6,4	.312	7,9	.250	6,4	.312	7,9	.250	6,4	.250	6,4

A	PART NO. Natural	DESCRIPTION	PART NO. Natural	DESCRIPTION	PART NO. Natural	DESCRIPTION	PART NO. Natural	DESCRIPTION	
									in.
.187	4,8	10553	HBS-03	10562	HBS2-03			10578	HBS4-03
.250	6,4	10554	HBS-04	10563	HBS2-04	10571	HBS3-04	10579	HBS4-04
.375	9,5	10555	HBS-06	10564	HBS2-06	10572	HBS3-06	10580	HBS4-06
.437	11,1	10556	HBS-07	10565	HBS2-07			10581	HBS4-07
.500	12,7	10557	HBS-08	10566	HBS2-08	10573	HBS3-08	10582	HBS4-08
.625	15,9	10558	HBS-10	10567	HBS2-10	10574	HBS3-10	10583	HBS4-10
.750	19,1	10559	HBS-12	10568	HBS2-12	10575	HBS3-12	10584	HBS4-12
.875	22,2	10560	HBS-14	10569	HBS2-14	10576	HBS3-14	10585	HBS4-14

Standard color natural. For special order parts in UL 94V-0 natural material, add the suffix “F” to Part No.

*Quick
Specs*

Material Nylon 6/6
Flammability Rating 94V-2
Temperature Range -40°F (-40°C) to 185°F (85°C)

"Stay Connected" with



HEYware

a PennEngineering® Company

Heyco® Nylon PCB Supports - Blind and Key Slot Mount

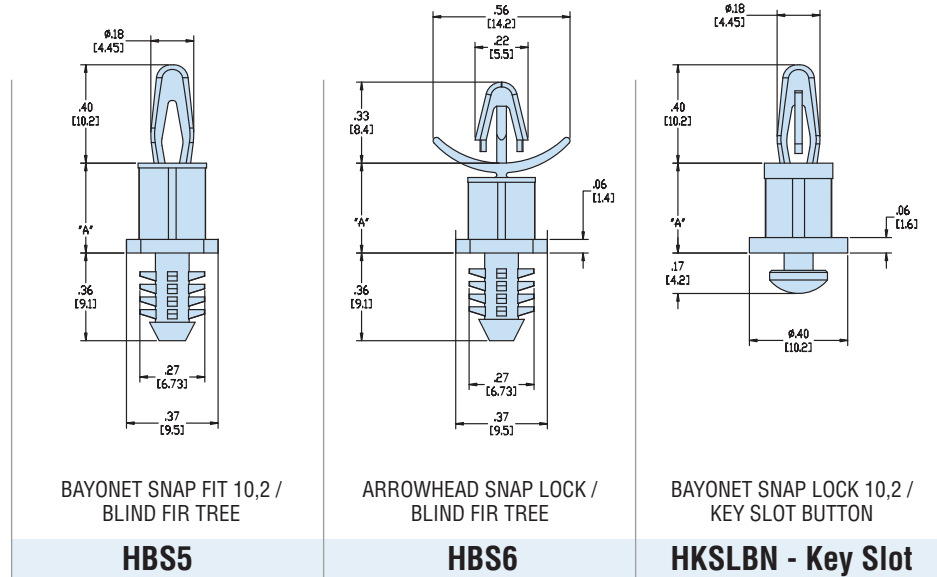

	Minimum Thickness		Mounting Hole Diameter		Minimum Thickness		Mounting Hole Diameter		Maximum Thickness		Mounting Slot Width	
	in.	mm.	in.	mm.	in.	mm.	in.	mm.	in.	mm.	in.	mm.
PCB	.062	1,6	.157	4,0	.078	2,0	.157	4,0	.062	1,6	.157	4,0
Chassis	.250	6,4	.250	6,4	.250	6,4	.250	6,4	.062	1,6	see diagram	

A		PART NO. Natural	DESCRIPTION	PART NO. Natural	DESCRIPTION	PART NO. Natural	DESCRIPTION
in.	mm.						
.125	3,2					10611	HKSLBN-02
.187	4,8	10587	HBS5-03				
.250	6,4	10588	HBS5-04	10596	HBS6-04	10612	HKSLBN-04
.375	9,5	10589	HBS5-06	10597	HBS6-06	10613	HKSLBN-06
.437	11,1	10590	HBS5-07				
.500	12,7	10591	HBS5-08	10598	HBS6-08	10614	HKSLBN-08
.625	15,9	10592	HBS5-10	10599	HBS6-10		
.750	19,1	10593	HBS5-12	10600	HBS6-12		
.875	22,2	10594	HBS5-14	10601	HBS6-14		

Standard color natural. For special order parts in UL 94V-0 natural material, add the suffix "F" to Part No.

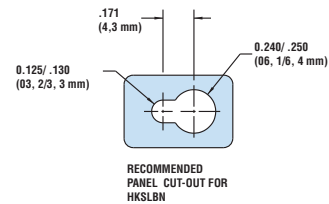

Material: Nylon 6/6
 Flammability Rating: 94V-2
 Temperature Range: -40°F (-40°C) to 185°F (85°C)

Quick
Specs

Heyco® Nylon PCB Supports - Stackable Self-Retaining Spacers

- May be stacked for multi-level PCB applications.
- Self aligning.
- One end locks into PCB.
- Clear hole variations for #4, #6 or #8 screw.

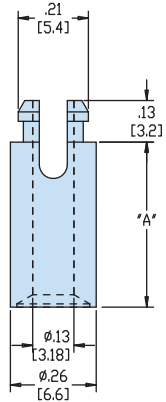

TWO PRONG SNAP LOCK / #4 SELF-TAPPING SCREW

HSSRS4

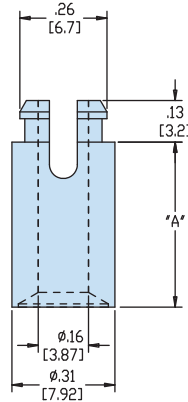

TWO PRONG SNAP LOCK / #6 SELF-TAPPING SCREW

HSSRS6

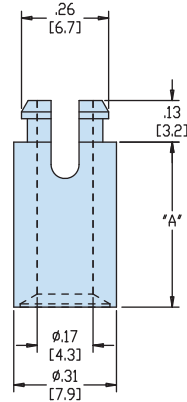

TWO PRONG SNAP LOCK / #8 SELF-TAPPING SCREW

HSSRS8



	Maximum Thickness		Mounting Hole Diameter		Maximum Thickness		Mounting Hole Diameter		Maximum Thickness		Mounting Hole Diameter	
	in.	mm.	in.	mm.	in.	mm.	in.	mm.	in.	mm.	in.	mm.
PCB	.062	1,6	.187	4,7	.062	1,6	.232	5,9	.062	1,6	.232	5,9
Chassis	self-tapping		#4		self-tapping		#6		self-tapping		#8 M4	

A		PART NO. FR Natural	DESCRIPTION	PART NO. FR Natural	DESCRIPTION	PART NO. Natural*	DESCRIPTION
in.	mm.						
.125	3,2	3681	HSSRS4-02				
.187	4,8	3683	HSSRS4-03				
.250	6,4	3684	HSSRS4-04	3689	HSSRS6-04	10857	HSSRS8-04
.312	7,9	10926	HSSRS4-05			10858	HSSRS8-05 NEW!
.375	9,5	3685	HSSRS4-06	3690	HSSRS6-06	10859	HSSRS8-06
.413	10,5	3686	HSSRS4-413				NEW!
.437	11,1	10928	HSSRS4-07			10860	HSSRS8-07 NEW!
.500	12,7	3687	HSSRS4-08	3691	HSSRS6-08	10861	HSSRS8-08
.625	15,9	3688	HSSRS4-10	3692	HSSRS6-10	10862	HSSRS8-10
.750	19,1	10931	HSSRS4-12			10863	HSSRS8-12 NEW!
.875	22,2	10932	HSSRS4-14			10864	HSSRS8-14 NEW!
1.000	25,4	10933	HSSRS4-16			10865	HSSRS8-16 NEW!

Standard material is FR natural.

*HSSRS8 standard material is UL 94V-2 natural.

Quick Specs

Material: Nylon 6/6
 Flammability Rating: HSSRS4 & HSSRS6 - 94V-0; HSSRS8 - 94V-2
 Temperature Range: -40°F (-40°C) to 185°F (85°C)

Heyco® Nylon PCB Supports - Thru Hole Self-Retaining Spacers

- Large surface area base will not deform under heavy pre-load.
- One end locks into PCB.
- Clear hole variations for #4, #6 or #8 screw.

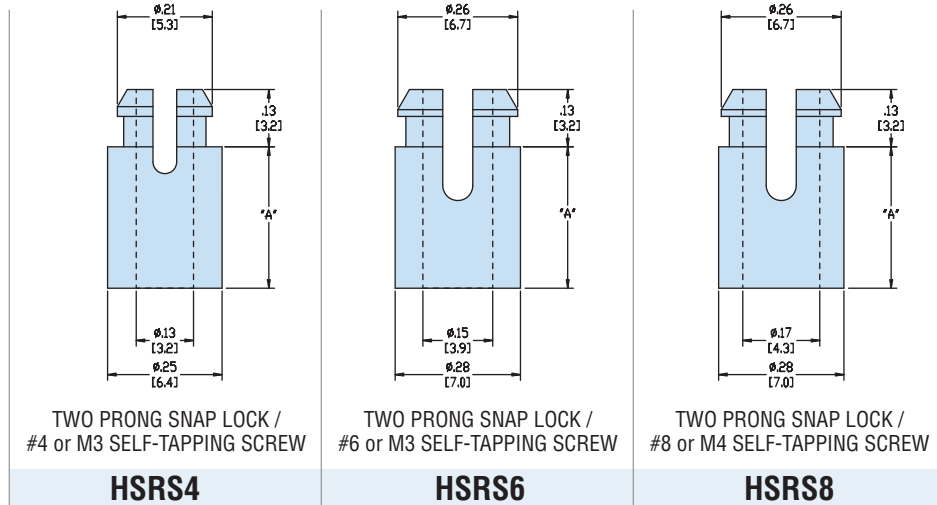

	Maximum Thickness †		Mounting Hole Diameter		Maximum Thickness †		Mounting Hole Diameter		Maximum Thickness †		Mounting Hole Diameter	
	in.	mm.	in.	mm.	in.	mm.	in.	mm.	in.	mm.	in.	mm.
PCB	.062	1,6	.187	4,7	.062	1,6	.232	5,9	.062	1,6	.232	5,9
Chassis	self-tapping		M3		self-tapping		M3		self-tapping		M4	

A		PART NO. Natural	DESCRIPTION	PART NO. Natural	DESCRIPTION	PART NO. Natural	DESCRIPTION
in.	mm.						
.125	3,2	10627	HSRS4-02				
.187	4,8	10628	HSRS4-03				
.250	6,4	10629	HSRS4-04	10639	HSRS6-04	10649	HSRS8-04
.312	7,9	10630	HSRS4-05	10640	HSRS6-05	10650	HSRS8-05
.375	9,5	10631	HSRS4-06	10641	HSRS6-06	10651	HSRS8-06
.437	11,1	10632	HSRS4-07	10642	HSRS6-07	10652	HSRS8-07
.500	12,7	10633	HSRS4-08	10643	HSRS6-08	10653	HSRS8-08
.625	15,9	10634	HSRS4-10	10644	HSRS6-10	10654	HSRS8-10
.750	19,1	10635	HSRS4-12	10645	HSRS6-12	10655	HSRS8-12
.875	22,2	10636	HSRS4-14	10646	HSRS6-14	10656	HSRS8-14
1.000	25,4	10637	HSRS4-16	10647	HSRS6-16	10657	HSRS8-16

Standard color natural. For special order parts in UL 94V-0 natural material, add the suffix “F” to Part No.

†Thread depth at Chassis end. For HRSR4, -6 and -8, thread depth = “A” dimension

Material: Nylon 6/6
 Flammability Rating: 94V-2
 Temperature Range: -40°F (-40°C) to 185°F (85°C)

Quick Specs

Heyco® Nylon PCB Supports - Screw and Lock

▼ ALL NEW PRODUCTS! ▼

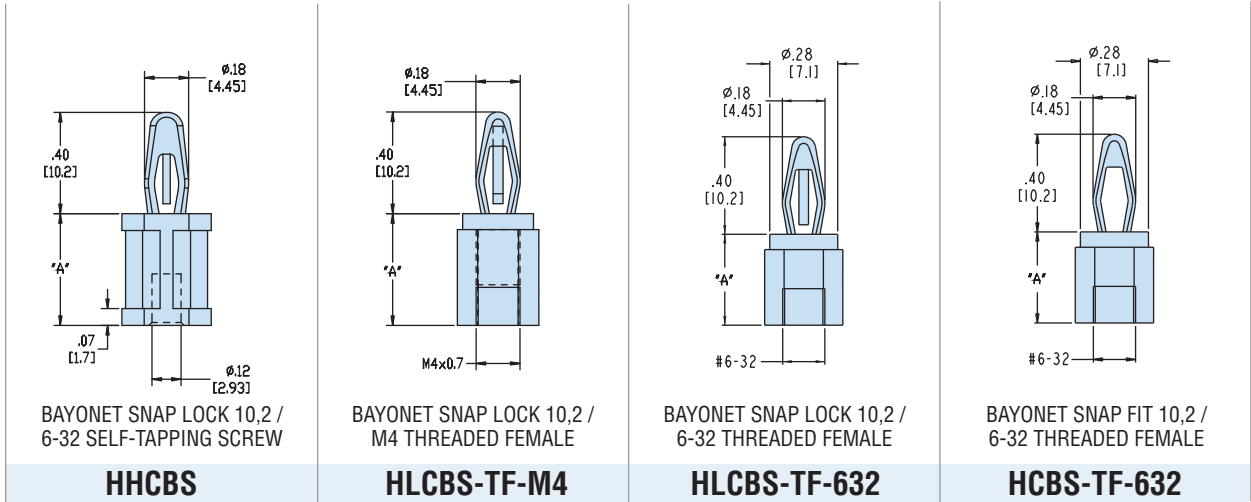

	Maximum Thickness*		Mounting Hole Diameter		Maximum Thickness		Mounting Hole Diameter		Maximum Thickness		Mounting Hole Diameter	
	in.	mm.	in.	mm.	in.	mm.	in.	mm.	in.	mm.	in.	mm.
PCB	.062	1,6	.157	4,0	.062	1,6	.157	4,0	.062	1,6	.157	4,0
Chassis	.312	7,9	6-32		threaded		M4		threaded		6-32	

A		PART NO. Natural	DESCRIPTION	PART NO. Natural**	DESCRIPTION	PART NO. Natural**	DESCRIPTION	PART NO. Natural**	DESCRIPTION
in.	mm.								
.250	6,4	10616	HHCBS-04 †						
.375	9,5	10617	HHCBS-06	10829	HLCBS-TF-M4-06	10890	HLCBS-TF-632-06	10897	HCBS-TF-632-06
.500	12,7	10618	HHCBS-08	10830	HLCBS-TF-M4-08	10891	HLCBS-TF-632-08	10898	HCBS-TF-632-08
.625	15,9	10619	HHCBS-10	10831	HLCBS-TF-M4-10	10892	HLCBS-TF-632-10	10899	HCBS-TF-632-10
.750	19,1	10620	HHCBS-12	10832	HLCBS-TF-M4-12	10893	HLCBS-TF-632-12	10900	HCBS-TF-632-12
.875	22,2	10621	HHCBS-14	10833	HLCBS-TF-M4-14	10894	HLCBS-TF-632-14	10901	HCBS-TF-632-14
1.000	25,4	10622	HHCBS-16	10834	HLCBS-TF-M4-16	10895	HLCBS-TF-632-16	10902	HCBS-TF-632-16
1.125	28,6	10623	HHCBS-18						
1.250	31,8	10624	HHCBS-20						
1.406	35,7	10625	HHCBS-22.5						

Standard color natural. For special order parts in UL 94V-0 natural material, add the suffix “F” to Part No.

*Refers to thread depth at chassis which is .312” (7,9 mm)

**Consult Heyco for HLCBS-TF in V-0 material

†Thread depth is .20” (5,2 mm)

Quick
Specs

Material: Nylon 6/6
 Flammability Rating: 94V-2
 Temperature Range: -40°F (-40°C) to 185°F (85°C)

“Stay Connected” with



HEYware

a PennEngineering® Company

Heyco® Nylon PCB Supports - Threaded Male

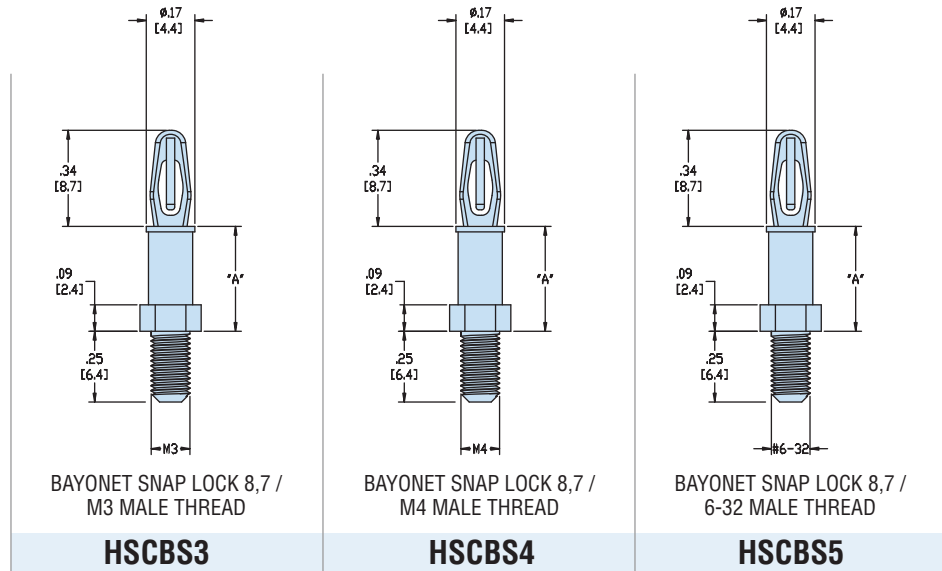

	Maximum Thickness †		Mounting Hole Diameter		Maximum Thickness †		Mounting Hole Diameter		Maximum Thickness †		Mounting Hole Diameter	
	in.	mm.	in.	mm.	in.	mm.	in.	mm.	in.	mm.	in.	mm.
PCB	.062	1,6	.125	3,2	.062	1,6	.125	3,2	.062	1,6	.125	3,2
Chassis	.250	6,4		M3	.250	6,4		M4	.250	6,4		6-32

A		PART NO. Natural	DESCRIPTION	PART NO. Natural	DESCRIPTION	PART NO. Natural	DESCRIPTION
in.	mm.						
.125	3,2	10716	HSCBS3-02	10726	HSCBS4-02	10736	HSCBS5-02
.187	4,8	10717	HSCBS3-03	10727	HSCBS4-03	10737	HSCBS5-03
.250	6,4	10718	HSCBS3-04	10728	HSCBS4-04	10738	HSCBS5-04
.312	7,9	10719	HSCBS3-05	10729	HSCBS4-05	10739	HSCBS5-05
.375	9,5	10720	HSCBS3-06	10730	HSCBS4-06	10740	HSCBS5-06
.437	11,1	10721	HSCBS3-07	10731	HSCBS4-07	10741	HSCBS5-07
.500	12,7	10722	HSCBS3-08	10732	HSCBS4-08	10742	HSCBS5-08
.562	14,3	10723	HSCBS3-09	10733	HSCBS4-09	10743	HSCBS5-09
.625	15,9	10724	HSCBS3-10	10734	HSCBS4-10	10744	HSCBS5-10

Standard color natural. For special order parts in UL 94V-0 natural material, add the suffix “F” to Part No.

† Indicates thread length for Chassis end of part.

Material: Nylon 6/6
 Flammability Rating: 94V-2
 Temperature Range: -40°F (-40°C) to 185°F (85°C)

*Quick
Specs*

Heyco® Nylon PCB Supports - Threaded Male

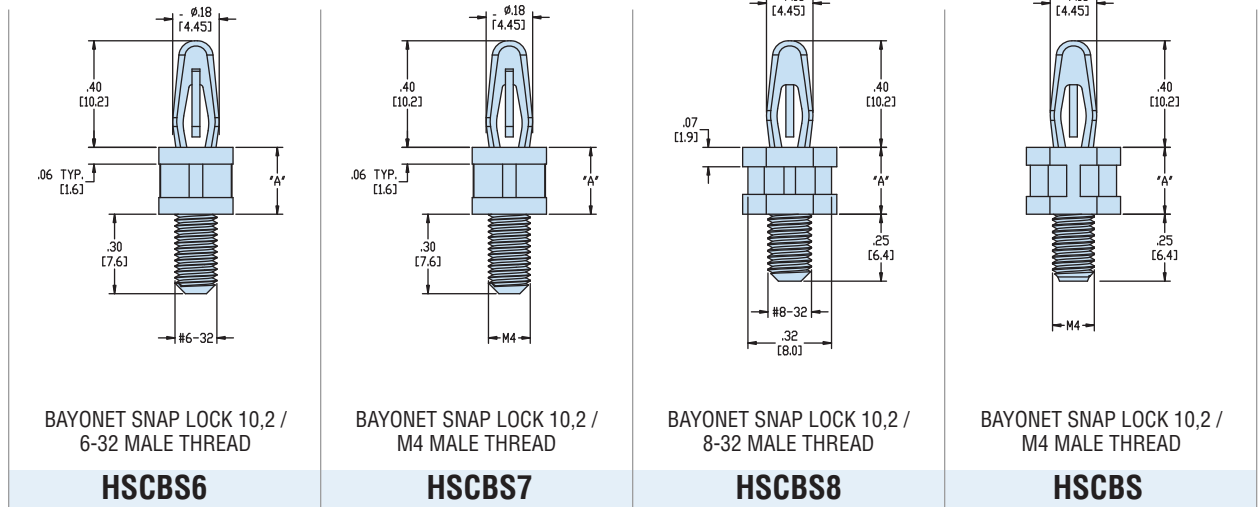

	Maximum Thickness †		Mounting Hole Diameter		Maximum Thickness †		Mounting Hole Diameter		Maximum Thickness †		Mounting Hole Diameter		Maximum Thickness †		Mounting Hole Diameter	
	in.	mm.	in.	mm.	in.	mm.	in.	mm.	in.	mm.	in.	mm.	in.	mm.	in.	mm.
PCB	.062	1,6	.157	4,0	.062	1,6	.157	4,0	.062	1,6	.157	4,0	.062	1,6	.157	4,0
Chassis	.300	7,6	6-32		.300	7,6	M4		.250	6,4	8-32		.250	6,4	M4	

A		PART NO. Natural	DESCRIPTION	PART NO. Natural	DESCRIPTION	PART NO. Natural	DESCRIPTION	PART NO. Natural	DESCRIPTION
in.	mm.								
.250	6,4	10746	HSCBS6-04	10754	HSCBS7-04	10762	HSCBS8-04	10678	HSCBS-04
.375	9,5	10747	HSCBS6-06	10755	HSCBS7-06	10763	HSCBS8-06	10679	HSCBS-06
.500	12,7	10748	HSCBS6-08	10756	HSCBS7-08	10764	HSCBS8-08	10680	HSCBS-08
.625	15,9	10749	HSCBS6-10	10757	HSCBS7-10	10765	HSCBS8-10	10681	HSCBS-10
.750	19,1	10750	HSCBS6-12	10758	HSCBS7-12	10766	HSCBS8-12	10682	HSCBS-12
.812	20,6							10683	HSCBS-13
.875	22,2	10751	HSCBS6-14	10759	HSCBS7-14	10767	HSCBS8-14	10684	HSCBS-14
1.000	25,4	10752	HSCBS6-16	10760	HSCBS7-16	10768	HSCBS8-16	10685	HSCBS-16
1.125	28,6					10769	HSCBS8-18	10686	HSCBS-18
1.406	35,7					10770	HSCBS8-22.5	10687	HSCBS-22.5

Standard color natural. For special order parts in UL 94V-0 natural material, add the suffix "F" to Part No.

† Indicates thread length for Chassis end of part.

*Quick
Specs*

Material Nylon 6/6
 Flammability Rating 94V-2
 Temperature Range -40°F (-40°C) to 185°F (85°C)

“Stay Connected” with



HEYware

a PennEngineering® Company

Heyco® Nylon PCB Supports - Threaded Male

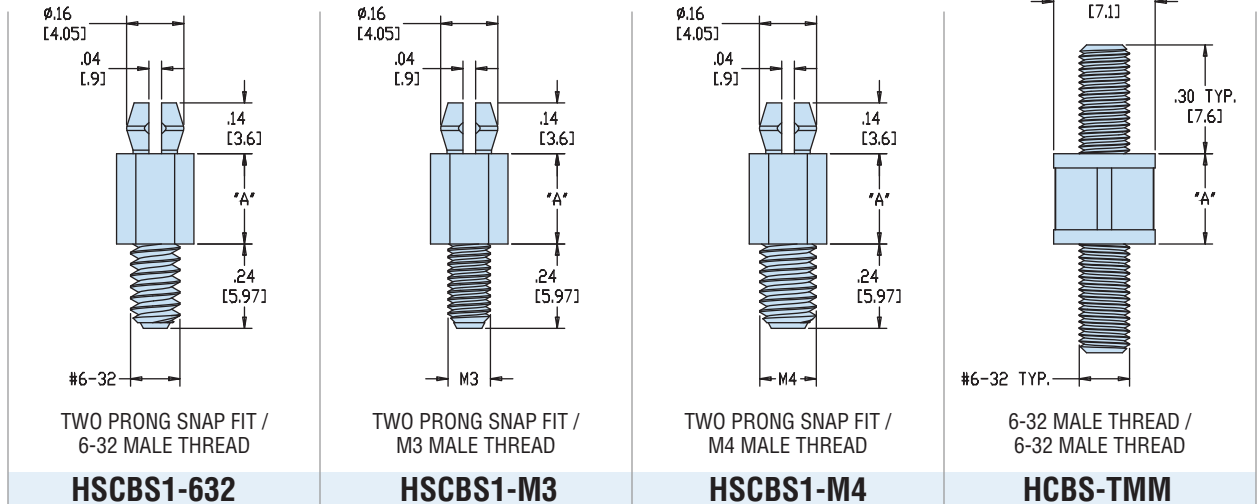

	Maximum Thickness †		Mounting Hole Diameter		Maximum Thickness †		Mounting Hole Diameter		Maximum Thickness †		Mounting Hole Diameter		Thread Length		Mounting Hole Diameter	
	in.	mm.	in.	mm.	in.	mm.	in.	mm.	in.	mm.	in.	mm.	in.	mm.	in.	mm.
PCB	.062	1,6	.153	3,9	.062	1,6	.153	3,9	.062	1,6	.153	3,9	.300	7,6	6-32	
Chassis	.236	6,0	6-32		.236	6,0		M3	.236	6,0		M4	.300	7,6	6-32	

A		PART NO. Natural	DESCRIPTION	PART NO. Natural*	DESCRIPTION	PART NO. Natural*	DESCRIPTION	PART NO. Natural	DESCRIPTION
in.	mm.								
.125	3,2	10689	HSCBS1-632-02	10698	HSCBS1-M3-02	10707	HSCBS1-M4-02		
.187	4,8	10690	HSCBS1-632-03	10699	HSCBS1-M3-03	10708	HSCBS1-M4-03		
.250	6,4	10691	HSCBS1-632-04	10700	HSCBS1-M3-04	10709	HSCBS1-M4-04	10817	HCBS-TMM-04
.375	9,5	10692	HSCBS1-632-06	10701	HSCBS1-M3-06	10710	HSCBS1-M4-06	10818	HCBS-TMM-06
.500	12,7	10693	HSCBS1-632-08	10702	HSCBS1-M3-08	10711	HSCBS1-M4-08	10819	HCBS-TMM-08
.625	15,9	10694	HSCBS1-632-10	10703	HSCBS1-M3-10	10712	HSCBS1-M4-10	10820	HCBS-TMM-10
.750	19,1	10695	HSCBS1-632-12	10704	HSCBS1-M3-12	10713	HSCBS1-M4-12	10821	HCBS-TMM-12
.875	22,2	10696	HSCBS1-632-14	10705	HSCBS1-M3-14	10714	HSCBS1-M4-14	10822	HCBS-TMM-14
1.000	25,4							10823	HCBS-TMM-16

Standard color natural. For special order parts in UL 94V-0 natural material, add the suffix “F” to Part No.

*Consult Heyco for HSCBS1-M3 and HSCBS1-M4 in V-0 material.

† Indicates thread length for Chassis end of part.

Material: Nylon 6/6
 Flammability Rating: 94V-2
 Temperature Range: -40°F (-40°C) to 185°F (85°C)

Quick
Specs

“Stay Connected” with



HEYware

a PennEngineering® Company

Heyco® Nylon PCB Supports - Adhesive-Back Mount

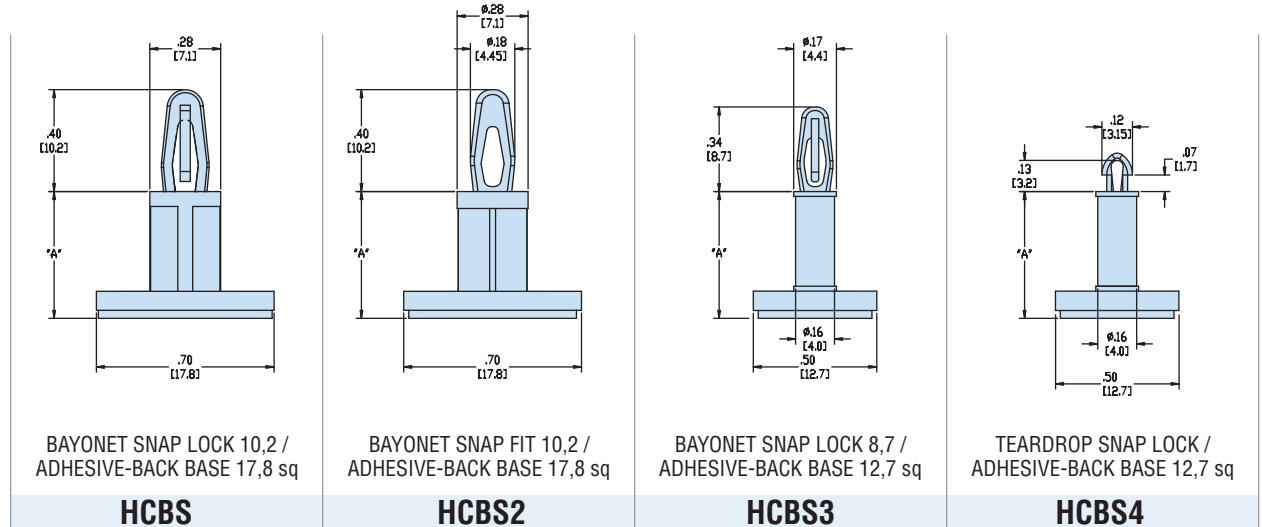

PCB	Maximum Thickness		Mounting Hole Diameter		PCB	Maximum Thickness		Mounting Hole Diameter		PCB	Maximum Thickness		Mounting Hole Diameter						
	in.	mm.	in.	mm.		in.	mm.	in.	mm.		in.	mm.	in.	mm.					
	.062	1,6	.157	4,0		.062	1,6	.157	4,0		.062	1,6	.125	3,2		.062	1,6	.098	2,5
Chassis	adhesive-back mount					adhesive-back mount					adhesive-back mount					adhesive-back mount			
A		PART NO.	DESCRIPTION	PART NO.	DESCRIPTION	PART NO.	DESCRIPTION	PART NO.	DESCRIPTION	PART NO.	DESCRIPTION	PART NO.	DESCRIPTION	PART NO.	DESCRIPTION	PART NO.	DESCRIPTION	PART NO.	DESCRIPTION
in.	mm.	Natural		Natural		Natural		Natural		Natural		Natural		Natural		Natural		Natural	
.187	4,8	10772	HCBS-03-AB	10784	HCBS2-03-AB	10794	HCBS3-03-AB	10803	HCBS4-03-AB										
.250	6,4	10773	HCBS-04-AB	10785	HCBS2-04-AB	10795	HCBS3-04-AB	10804	HCBS4-04-AB										
.312	7,9					10796	HCBS3-05-AB												
.375	9,5	10774	HCBS-06-AB	10786	HCBS2-06-AB	10797	HCBS3-06-AB	10805	HCBS4-06-AB										
.437	11,1					10798	HCBS3-07-AB	10806	HCBS4-07-AB										
.500	12,7	10775	HCBS-08-AB	10787	HCBS2-08-AB	10799	HCBS3-08-AB	10807	HCBS4-08-AB										
.562	14,3					10800	HCBS3-09-AB												
.625	15,9	10776	HCBS-10-AB	10788	HCBS2-10-AB	10801	HCBS3-10-AB	10808	HCBS4-10-AB										
.750	19,1	10777	HCBS-12-AB	10789	HCBS2-12-AB														
.875	22,2	10778	HCBS-14-AB	10790	HCBS2-14-AB														
1.000	25,4	10779	HCBS-16-AB	10791	HCBS2-16-AB														
1.125	28,6	10780	HCBS-18-AB	10792	HCBS2-18-AB														

Standard color natural.

Quick Specs

Material Nylon 6/6
 Flammability Rating 94V-2
 Temperature Range -40°F (-40°C) to 185°F (85°C)

“Stay Connected” with



HEYware

a PennEngineering® Company

Heyco® Nylon PCB Supports - Adhesive-Back Mount

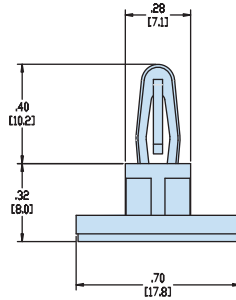

BAYONET SNAP LOCK 10,2 /
ADHESIVE-BACK BASE 17,8 sq

HCBS-Metric

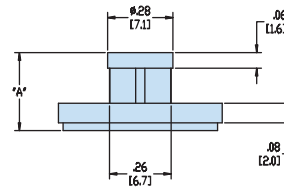

FLAT TOP REST MOUNT /
ADHESIVE-BACK BASE 17,8 sq

HPSB

	Maximum Thickness		Mounting Hole Diameter		Maximum Thickness		Mounting Hole Diameter	
	in.	mm.	in.	mm.	in.	mm.	in.	mm.
PCB	.062	1,6	.157	4,0	flat top rest mount			
Chassis	adhesive-back mount				adhesive-back mount			
A mm.	PART NO. Natural	DESCRIPTION		PART NO. Natural V-0	DESCRIPTION			
6,0	10771	HCBS-06M-AB		10810F	HPSB-06M-AB		NEW!	
8,0	10781	HCBS-08M-AB		10811F	HPSB-08M-AB			
10,0	10782	HCBS-10M-AB		10812F	HPSB-10M-AB			
12,0	10783	HCBS-12M-AB		10813F	HPSB-12M-AB		NEW!	
14,0				10814F	HPSB-14M-AB			
16,0				10815F	HPSB-16M-AB			

Standard color natural. *For special order parts in UL 94V-0 natural material, add the suffix “F” to Part No. Note: Consult Heyco for HCBS in V-0 material. V-0 material is standard for HPSB series parts.

Material: Nylon 6/6
 Flammability Rating: HCBS - 94V-2, HPSB - 94V-0
 Temperature Range: -40°F (-40°C) to 185°F (85°C)

*Quick
Specs*

Heyco® Nylon PCB Supports - Rivet Mount

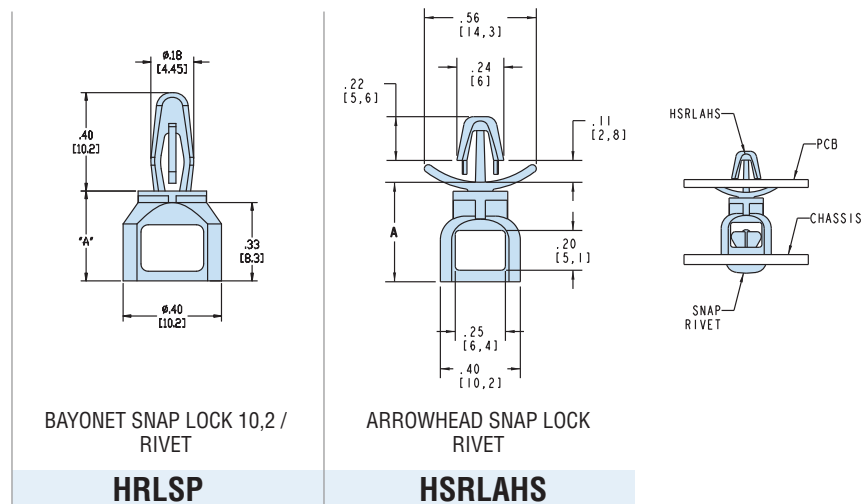

	Minimum Thickness		Mounting Hole Diameter		Minimum Thickness		Mounting Hole Diameter	
	in.	mm.	in.	mm.	in.	mm.	in.	mm.
PCB	.062	1,6	.157	4,0	.062	1,6	.187	4,8
Chassis	see table		.165	4,2	see table		.161	4,0

A		PART NO. Natural	DESCRIPTION	PART NO. Natural	DESCRIPTION
in.	mm.				
.375	9,5	10603	HRLSP-06		
.437	11,1	10604	HRLSP-07	10878	HSRLAHS-07
.500	12,7	10605	HRLSP-08	10879	HSRLAHS-08
.625	15,9	10606	HRLSP-10	10880	HSRLAHS-10
.750	19,1	10607	HRLSP-12	10881	HSRLAHS-12
.875	22,2	10608	HRLSP-14	10882	HSRLAHS-14
1.000	25,4	10609	HRLSP-16	10883	HSRLAHS-16

Standard color natural. For special order parts in UL 94V-0 natural material, add the suffix “F” to Part No.

- Rivet applied from Chassis side.

Rivet Table		
PART NO.	CHASSIS THICKNESS	
	in.	mm.
9058	.03 - .06	0,7 - 1,6
9060	.06 - .11	1,6 - 2,7
9062	.11 - .15	2,7 - 3,7
9064	.15 - .18	3,7 - 4,7
9066	.18 - .22	4,7 - 5,7
9068	.22 - .26	5,7 - 6,7
9318	.28 - .34	7,2 - 8,7

Quick Specs

Material	Nylon 6/6
Certifications	Recognized under the Component Program of Underwriters' Laboratories File F197049
Flammability Rating	94V-2
Temperature Range	-40°F (-40°C) to 185°F (85°C)

Heyco® Nylon PCB Supports - Edge Holding

▼ ALL NEW PRODUCTS! ▼

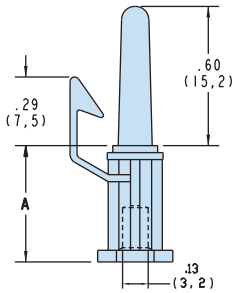

EDGE SNAP LOCK /
#6 SELF-TAPPING SCREW

HTEHCBS

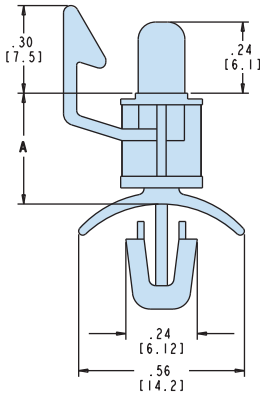

EDGE SNAP LOCK /
ARROWHEAD SNAP LOCK

HEHCBS-7

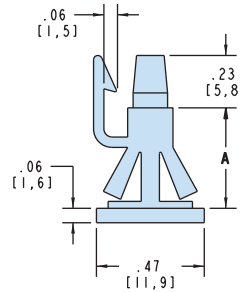

EDGE SNAP LOCK /
REVERSE RECTANGULAR LOCK

HRLEHCBS

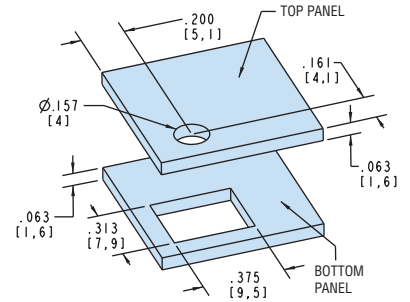

PCB	Maximum Thickness		Mounting Hole Diameter		PCB	Maximum Thickness		Mounting Hole Diameter		PCB	Maximum Thickness		Mounting Hole Diameter	
	in.	mm.	in.	mm.		in.	mm.	in.	mm.		in.	mm.	in.	mm.
	.062	1,6	.157	4,0		.062	1,6	.157	4,0		.062	1,6	.157	4,0
Chassis	Varies		#6 Screw			.078		2,0			Varies		#6 Screw	

A	PART NO.	DESCRIPTION	PART NO.	DESCRIPTION	PART NO.	DESCRIPTION
in. mm.	Natural*		Natural*		Black	
.250 6,4	10935	HTEHCBS-04				
.312 7,9	10936	HTEHCBS-05			10885B	HRLEHCBS-05
.375 9,5	10937	HTEHCBS-06	10825	HEHCBS-7-06	10886B	HRLEHCBS-06
.500 12,7	10939	HTEHCBS-08				
.625 15,9	10941	HTEHCBS-10				
.750 19,1	10942	HTEHCBS-12				
.875 22,2	10943	HTEHCBS-14	10826	HEHCBS-7-14		
1.000 25,4	10944	HTEHCBS-16				

Standard color as shown. *For special order parts in UL 94V-0 material, add the suffix "F" to Part No.

Material: Nylon 6/6
 Certifications: Recognized under the Component Program of Underwriters' Laboratories File F197049
 Flammability Rating: 94V-2
 Temperature Range: -40°F (-40°C) to 185°F (85°C)

Quick
Specs

Heyco® Nylon Male/Female Threaded Hex Supports

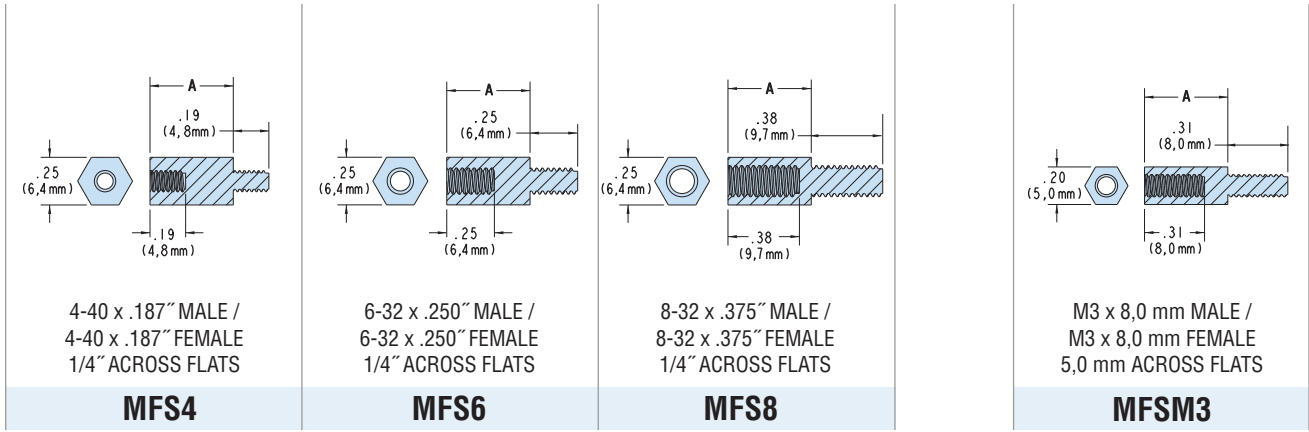

	Thread Length		Mounting Hole Diameter		Thread Length		Mounting Hole Diameter		Thread Length		Mounting Hole Diameter		Thread Length		Mounting Hole Diameter	
	in.	mm.	in.	mm.	in.	mm.	in.	mm.	in.	mm.	in.	mm.	mm.	in.	mm.	mm.
Male end	.187	4,8	4-40		.250	6,4	6-32		.375	9,5	8-32		8,0	.315		M3
Female end	.187	4,8	4-40		.250	6,4	6-32		.375	9,5	8-32		8,0	.315		M3

A	PART NO.	DESCRIPTION	PART NO.	DESCRIPTION	PART NO.	DESCRIPTION	A	PART NO.	DESCRIPTION		
in.	mm.	Natural	Natural	Natural	Natural	Natural	mm.	in.	Natural		
.250	6,4	11800	MFS4-04	11820	MFS6-04 †	11840	MFS8-04 †	6,0	.236	11859	MFSM3-M06 NEW!
.276	7,0	11801	MFS4-04.4					10,0	.394	11860	MFSM3-M10
.312	7,9	11802	MFS4-05*	11822	MFS6-05*			12,0	.472	11861	MFSM3-M12
.375	9,5	11803	MFS4-06	11823	MFS6-06	11843	MFS8-06 ††	15,0	.590	11862	MFSM3-M15
.437	11,1	11804	MFS4-07	11824	MFS6-07	11844	MFS8-07	18,0	.709	11863	MFSM3-M18
.500	12,7	11805	MFS4-08	11825	MFS6-08	11845	MFS8-08	20,0	.787	11864	MFSM3-M20
.562	14,3	11806	MFS4-09	11826	MFS6-09	11846	MFS8-09	25,0	.984	11865	MFSM3-M25
.600	15,2	11807	MFS4-09.6								
.625	15,9	11808	MFS4-10	11828	MFS6-10	11848	MFS8-10				
.687	17,4			11829	MFS6-11*						
.750	19,1	11810	MFS4-12	11830	MFS6-12	11850	MFS8-12				
.875	22,2	11811	MFS4-14	11831	MFS6-14	11851	MFS8-14				
.937	23,8			11832	MFS6-15						
1.000	25,4	11813	MFS4-16	11833	MFS6-16	11853	MFS8-16				
1.125	28,6	11814	MFS4-18	11834	MFS6-18	11854	MFS8-18				
1.250	31,8	11815	MFS4-20	11835	MFS6-20	11855	MFS8-20				
1.312	33,3			11836	MFS6-21						
1.375	34,9	11817	MFS4-22	11837	MFS6-22	11857	MFS8-22				
1.500	38,1			11839	MFS6-24						
2.000	50,8	11818	MFS4-32	11838	MFS6-32	11858	MFS8-32 NEW!				

Standard color natural.
 † Female thread depth is .190" (4,8 mm)
 †† Female thread depth is .200" (5,1 mm)
 * Special order.



Material	Nylon 6/6
Flammability Rating	94V-2
Temperature Range	-40°F (-40°C) to 185°F (85°C)

"Stay Connected" with



HEYware

a PennEngineering® Company



Heyco® Nylon Tapped Hex Spacers

Imperial Spacing and Threads

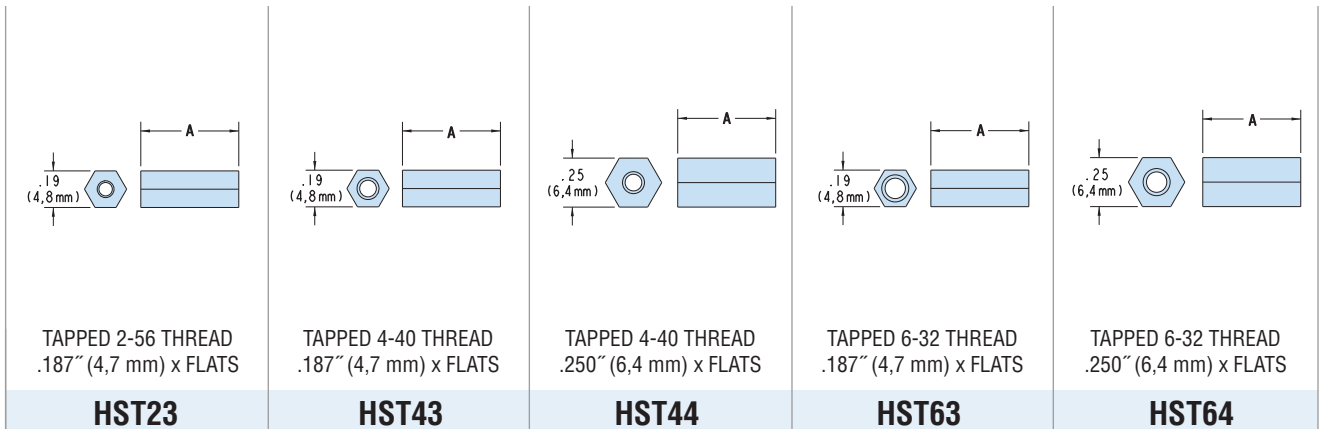

A		PART NO.		DESCRIPTION		PART NO.		DESCRIPTION		PART NO.		DESCRIPTION	
in.	mm.			Natural	Natural			Natural	Natural			Natural	Natural
.187	4,8	12500		HST23-03	12512	HST43-03	12524	HST44-03	12536	HST63-03	12552	HST64-03	
.250	6,4	12501		HST23-04	12513	HST43-04	12525	HST44-04	12537	HST63-04	12553	HST64-04	
.312	7,9	12502		HST23-05	12514	HST43-05	12526	HST44-05	12538	HST63-05	12554	HST64-05	
.375	9,5	12503		HST23-06	12515	HST43-06	12527	HST44-06	12539	HST63-06	12555	HST64-06	
.437	11,1	12504		HST23-07	12516	HST43-07	12528	HST44-07	12540	HST63-07	12556	HST64-07	
.500	12,7	12505		HST23-08	12517	HST43-08	12529	HST44-08	12541	HST63-08	12557	HST64-08	
.562	14,3	12506		HST23-09	12518	HST43-09	12530	HST44-09	12542	HST63-09	12558	HST64-09	
.625	15,9	12507		HST23-10	12519	HST43-10	12531	HST44-10	12543	HST63-10	12559	HST64-10	
.750	19,1	12508		HST23-12	12520	HST43-12	12532	HST44-12	12544	HST63-12	12560	HST64-12	
.875	22,2	12509		HST23-14	12521	HST43-14	12533	HST44-14	12545	HST63-14	12561	HST64-14	
1.000	25,4	12510		HST23-16	12522	HST43-16	12534	HST44-16	12546	HST63-16	12562	HST64-16	

Standard color natural.

Metric Spacing and Threads

- For Quick Specs see page 7-30.

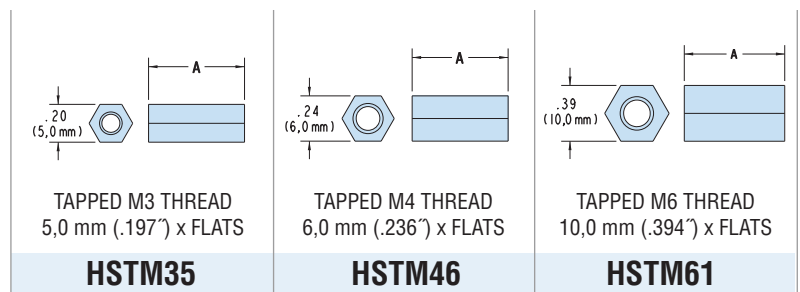

A		PART NO.		DESCRIPTION		PART NO.		DESCRIPTION		PART NO.		DESCRIPTION	
mm.	in.			Natural	Natural			Natural	Natural			Black	Black
6,0	.236	12584		HSTM35-M06	12599	HSTM46-M06							
6,4	.250	12585		HSTM35-M06.35*									
8,0	.315	12586		HSTM35-M08	12601	HSTM46-M08							
10,0	.394	12587		HSTM35-M10	12602	HSTM46-M10	12614	HSTM61-M10					
11,0	.433	12588		HSTM35-M11*									
12,0	.472	12589		HSTM35-M12	12604	HSTM46-M12	12616	HSTM61-M12					
13,0	.512	12590		HSTM35-M13*									
15,0	.590	12592		HSTM35-M15	12606	HSTM46-M15	12618	HSTM61-M15					
18,0	.709	12594		HSTM35-M18	12607	HSTM46-M18							
20,0	.787	12595		HSTM35-M20	12608	HSTM46-M20	12620	HSTM61-M20					
25,0	.984	12596		HSTM35-M25	12609	HSTM46-M25	12621	HSTM61-M25					
30,0							12622	HSTM61-M30					

Standard color as shown.
*Special order.



Heyco® “Standard Plus” Nylon Washers and Spacers

		PART NOS.								
Outside Dia. ➤		.187" (4,7 mm)		.250" (6,4 mm)				.312" (7,9 mm)		
Inside Dia. D ➤		.091" (2,3 mm)	.115" (2,9 mm)	.091" (2,3 mm)	.115" (2,9 mm)	.140" (3,6 mm)	.171" (4,3 mm)	.115" (2,9 mm)	.140" (3,6 mm)	.171" (4,3 mm)
A		#2	#4	#2	#4	#6	#8	#4	#6	#8
in.	mm.									
.032	0,8			RS-2509-0032	RS-2511-0032				RS-3114-0032	
.063	1,6	RS-1809-0063	RS-1811-0063	RS-2509-0063	RS-2511-0063	RS-2514-0063			RS-3114-0063	
.093	2,4			RS-2509-0093	RS-2511-0093				RS-3114-0093	
.125	3,2	RS-1809-0125	RS-1811-0125	RS-2509-0125	RS-2511-0125	RS-2514-0125	RS-2517-0125	RS-3111-0125	RS-3114-0125	RS-3117-0125
.156	4,0		RS-1811-0156*		RS-2511-0155*		RS-2517-0156*			
.187	4,7	RS-1809-0187	RS-1811-0187	RS-2509-0187	RS-2511-0187	RS-2514-0187	RS-2517-0187	RS-3111-0187	RS-3114-0187	RS-3117-0187
.250	6,4	RS-1809-0250	RS-1811-0250	RS-2509-0250	RS-2511-0250	RS-2514-0250	RS-2517-0250	RS-3111-0250	RS-3114-0250	RS-3117-0250
.312	7,9	RS-1809-0312	RS-1811-0312	RS-2509-0312	RS-2511-0312	RS-2514-0312	RS-2517-0312	RS-3111-0312	RS-3114-0312	RS-3117-0312
.375	9,5	RS-1809-0375	RS-1811-0375	RS-2509-0375	RS-2511-0375	RS-2514-0375	RS-2517-0375	RS-3111-0375	RS-3114-0375	RS-3117-0375
.405	10,3			RS-2509-0405*	RS-2511-0405*	RS-2514-0405*	RS-2517-0405*			
.437	11,1	RS-1809-0437	RS-1811-0437	RS-2509-0437	RS-2511-0437	RS-2514-0437	RS-2517-0437	RS-3111-0437	RS-3114-0437	RS-3117-0437
.500	12,7	RS-1809-0500	RS-1811-0500	RS-2509-0500	RS-2511-0500	RS-2514-0500	RS-2517-0500	RS-3111-0500	RS-3114-0500	RS-3117-0500
.562	14,3	RS-1809-0562	RS-1811-0562	RS-2509-0562	RS-2511-0562	RS-2514-0562	RS-2517-0562	RS-3111-0562	RS-3114-0562	RS-3117-0562
.625	15,9	RS-1809-0625	RS-1811-0625	RS-2509-0625	RS-2511-0625	RS-2514-0625	RS-2517-0625	RS-3111-0625	RS-3114-0625	RS-3117-0625
.687	17,4	RS-1809-0687	RS-1811-0687	RS-2509-0687	RS-2511-0687	RS-2514-0687	RS-2517-0687	RS-3111-0687	RS-3114-0687	RS-3117-0687
.750	19,1	RS-1809-0750	RS-1811-0750	RS-2509-0750	RS-2511-0750	RS-2514-0750	RS-2517-0750	RS-3111-0750	RS-3114-0750	RS-3117-0750
.812	20,6	RS-1809-0812	RS-1811-0812	RS-2509-0812	RS-2511-0812	RS-2514-0812	RS-2517-0812	RS-3111-0812	RS-3114-0812	RS-3117-0812
.875	22,2	RS-1809-0875	RS-1811-0875	RS-2509-0875	RS-2511-0875	RS-2514-0875	RS-2517-0875	RS-3111-0875	RS-3114-0875	RS-3117-0875
.937	23,8	RS-1809-0937	RS-1811-0937	RS-2509-0937	RS-2511-0937	RS-2514-0937	RS-2517-0937	RS-3111-0937	RS-3114-0937	RS-3117-0937
1.000	25,4	RS-1809-1000	RS-1811-1000	RS-2509-1000	RS-2511-1000	RS-2514-1000	RS-2517-1000	RS-3111-1000	RS-3114-1000	RS-3117-1000

Standard color natural

* “Plus” Length

- Ideal for use in electrical and electronic assemblies.
- Tough and resilient.
- Can also be used as bushings, bearings, rollers, and glides.
- Special sizes and lengths available. Consult Heyco.
- Tolerances: O.D. ±.015, I.D. ±.005, Length ±.015

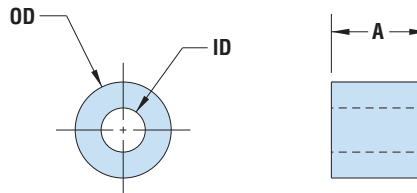

Quick Specs

Material: Nylon 6/6
 Flammability Rating: 94V-2
 Temperature Range: -40°F (-40°C) to 149° F (65°C)

"Stay Connected" with



HEYware

a PennEngineering® Company



Heyco® "Standard Plus" Nylon Washers and Spacers

Outside Dia. ➤		PART NOS.								
		.312" (7,9 mm)			.375" (9,5 mm)			.500" (12,7 mm)		
Inside Dia. D ➤		.194" (4,9 mm)	.140" (3,6 mm)	.171" (4,3 mm)	.194" (4,9 mm)	.140" (3,6 mm)	.171" (4,3 mm)	.194" (4,9 mm)	.219" (5,6 mm)	.257" (6,5 mm)
A		#10	#6	#8	#10	#6	#8	#10	#12	1/4-20
in.	mm.									
.032	0,8			RS-3717-0032	RS-3719-0032					RS-5025-0032
.063	1,6			RS-3717-0063	RS-3719-0063					RS-5025-0063
.093	2,4			RS-3717-0093	RS-3719-0093					RS-5025-0093
.125	3,2	RS-3119-0125	RS-3714-0125	RS-3717-0125	RS-3719-0125	RS-5014-0125	RS-5017-0125	RS-5019-0125	RS-5021-0125	RS-5025-0125
.187	4,7	RS-3119-0187	RS-3714-0187	RS-3717-0187	RS-3719-0187	RS-5014-0187	RS-5017-0187	RS-5019-0187	RS-5021-0187	RS-5025-0187
.250	6,4	RS-3119-0250	RS-3714-0250	RS-3717-0250	RS-3719-0250	RS-5014-0250	RS-5017-0250	RS-5019-0250	RS-5021-0250	RS-5025-0250
.312	7,9	RS-3119-0312	RS-3714-0312	RS-3717-0312	RS-3719-0312	RS-5014-0312	RS-5017-0312	RS-5019-0312	RS-5021-0312	RS-5025-0312
.375	9,5	RS-3119-0375	RS-3714-0375	RS-3717-0375	RS-3719-0375	RS-5014-0375	RS-5017-0375	RS-5019-0375	RS-5021-0375	RS-5025-0375
.385	9,8	RS-3119-0385*								
.437	11,1	RS-3119-0437	RS-3714-0437	RS-3717-0437	RS-3719-0437	RS-5014-0437	RS-5017-0437	RS-5019-0437	RS-5021-0437	RS-5025-0437
.500	12,7	RS-3119-0500	RS-3714-0500	RS-3717-0500	RS-3719-0500	RS-5014-0500	RS-5017-0500	RS-5019-0500	RS-5021-0500	RS-5025-0500
.562	14,3	RS-3119-0562	RS-3714-0562	RS-3717-0562	RS-3719-0562	RS-5014-0562	RS-5017-0562	RS-5019-0562	RS-5021-0562	RS-5025-0562
.625	15,9	RS-3119-0625	RS-3714-0625	RS-3717-0625	RS-3719-0625	RS-5014-0625	RS-5017-0625	RS-5019-0625	RS-5021-0625	RS-5025-0625
.687	17,4	RS-3119-0687	RS-3714-0687	RS-3717-0687	RS-3719-0687	RS-5014-0687	RS-5017-0687	RS-5019-0687	RS-5021-0687	RS-5025-0687
.750	19,1	RS-3119-0750	RS-3714-0750	RS-3717-0750	RS-3719-0750	RS-5014-0750	RS-5017-0750	RS-5019-0750	RS-5021-0750	RS-5025-0750
.812	20,6	RS-3119-0812	RS-3714-0812	RS-3717-0812	RS-3719-0812	RS-5014-0812	RS-5017-0812	RS-5019-0812	RS-5021-0812	RS-5025-0812
.875	22,2	RS-3119-0875	RS-3714-0875	RS-3717-0875	RS-3719-0875	RS-5014-0875	RS-5017-0875	RS-5019-0875	RS-5021-0875	RS-5025-0875
.937	23,8	RS-3119-0937	RS-3714-0937	RS-3717-0937	RS-3719-0937	RS-5014-0937	RS-5017-0937	RS-5019-0937	RS-5021-0937	RS-5025-0937
1.000	25,4	RS-3119-1000	RS-3714-1000	RS-3717-1000	RS-3719-1000	RS-5014-1000	RS-5017-1000	RS-5019-1000	RS-5021-1000	RS-5025-1000

Standard color natural
* "Plus" Length

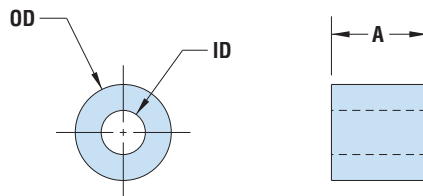

- Ideal for use in electrical and electronic assemblies.
- Tough and resilient.
- Can also be used as bushings, bearings, rollers, and glides.
- Special sizes and lengths available. Consult Heyco.
- Tolerances: O.D. ±.015, I.D. ±.005, Length ±.015

Material	Nylon 6/6
Flammability Rating	94V-2
Temperature Range	-40°F (-40°C) to 149° F (65°C)

Quick Specs

Heyco® PVC and Nylon LED Spacers

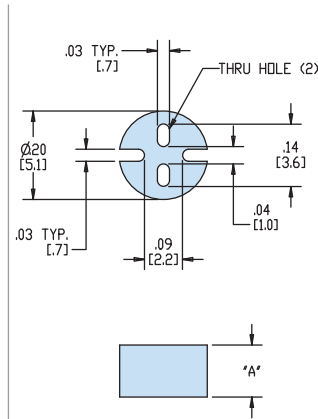

Fits T-1 3/4 (5 mm)

HLEDM-1

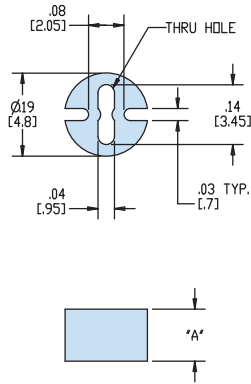

Fits T-1 (3 mm)

HLEDM-2

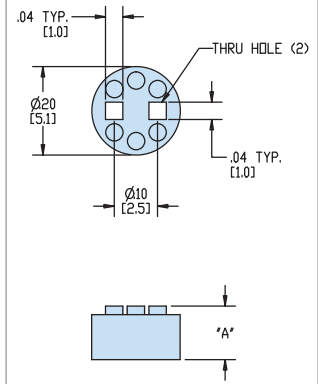

Fits T-1 3/4 (5 mm)

HLEDS2M

A mm.	PART NO. Black PVC	DESCRIPTION	PART NO. Black V-0	DESCRIPTION
2,0	11000	HLEDM-1-03M	11002F	HLEDM-2-02M
3,0			11003F	HLEDM-2-03M
5,0			11004F	HLEDM-2-05M
6,0			11005F	HLEDM-2-06M
7,0			11006F	HLEDM-2-07M
10,0			11010F	HLEDM-2-10M
12,0			11007F	HLEDM-2-12M
13,0			11008F	HLEDM-2-13M
17,0			11009F	HLEDM-2-17M
25,0			11001	HLEDM-1-25M

A		PART NO.	DESCRIPTION
in.	mm.	Natural	
.122	3,1	11011	HLEDS2M-120
.141	3,6	11012	HLEDS2M-140
.161	4,1	11013	HLEDS2M-160
.177	4,5	11014	HLEDS2M-180
.200	5,1	11015	HLEDS2M-200
.220	5,6	11016	HLEDS2M-220
.240	6,1	11017	HLEDS2M-240

Standard color as noted.

Heyco® Surface Mount Miniature Connectors

For additional information about Heyco PCB Surface Mount Miniature Connectors for LED PCB's, see page 8-37.



AWG	WIRE		Type	AMPS North America	POLES	PART NO. White	DESCRIPTION	Pieces per Coil	Coils per Box
	Size	mm ²							
SMMC Series									
24	0,20-		Solid or	6	1	4320	SMMC-1	2000	10
18	0,75		Flexible		2		4321	SMMC-2	
SMMC Release Pin Tool						0995	SMMC-T		

*Quick
Specs*

	HLEDM-1	HLEDM-2	HLEDS2M
Material	PVC	PVC	Nylon 6/6
Flammability Rating	94HB	94V-0	94V-2
Temperature Range	32°F (0°C) to 185°F (85°C) (All)		

Heyco® PVC and Nylon LED Spacers

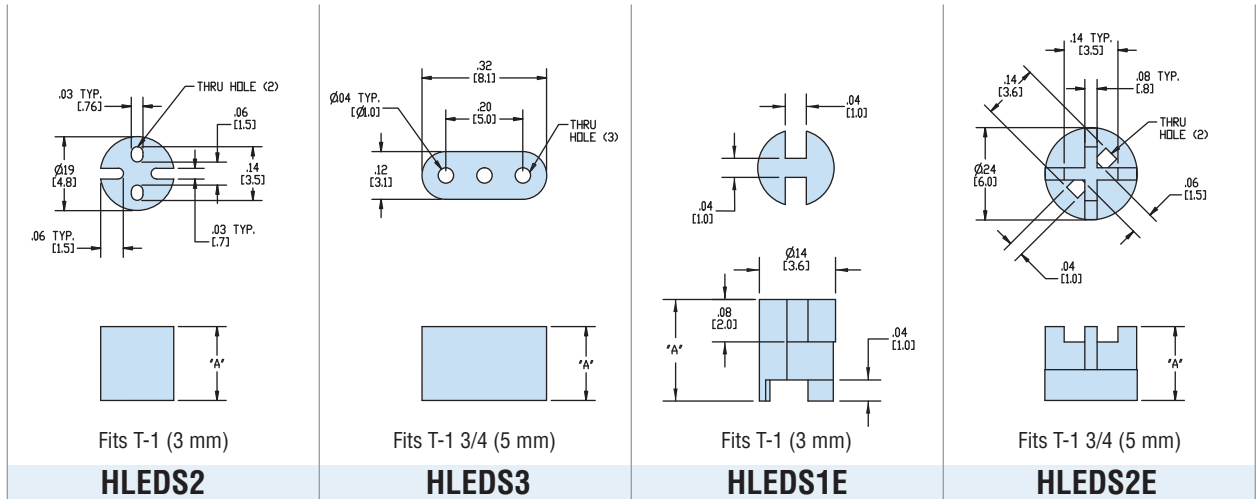

A		PART NO.	DESCRIPTION	PART NO.	DESCRIPTION	PART NO.	DESCRIPTION	PART NO.	DESCRIPTION
in.	mm.	Black PVC*		Black PVC		Natural		Natural	
.187	4,8			11025	HLEDS3-03	11032	HLEDS1E-03	11041	HLEDS2E-03
.250	6,4	11019	HLEDS2-04	11026	HLEDS3-04	11033	HLEDS1E-04	11042	HLEDS2E-04
.375	9,5	11020	HLEDS2-06	11027	HLEDS3-06	11034	HLEDS1E-06	11043	HLEDS2E-06
.500	12,7	11021	HLEDS2-08	11028	HLEDS3-08	11035	HLEDS1E-08	11044	HLEDS2E-08
.625	15,9	11022	HLEDS2-10	11029	HLEDS3-10	11036	HLEDS1E-10	11045	HLEDS2E-10
.750	19,1	11023	HLEDS2-12	11030	HLEDS3-12	11037	HLEDS1E-12	11046	HLEDS2E-12
.875	22,2					11038	HLEDS1E-14	11047	HLEDS2E-14
1.000	25,4					11039	HLEDS1E-16	11048	HLEDS2E-16

Standard as color noted.

*V-0 material available, consult Heyco.

For Heyco PCB Surface Mount Miniature Connectors for LED PCB's, contact Heyco.

Heyco® Transistor Insulators

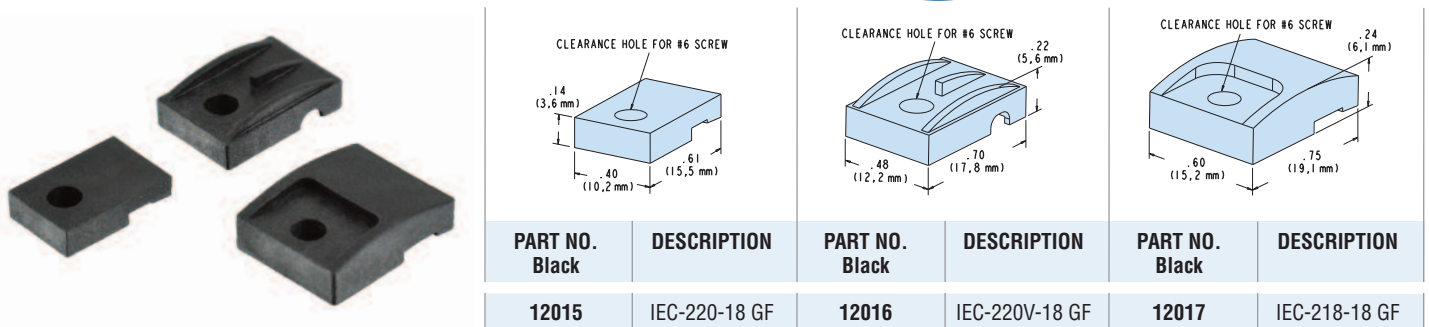

	HLEDS2	HLEDS3	HLEDS1E & HLEDS2E	Transistor Insulators
Material	PVC	PVC	Nylon 6/6	Nylon Glass-filled 6/6
Flammability Rating	94HB	94HB	94V-2	94HB
Temperature Range	32°F (0°C) to 185°F (85°C) (All)	see HLEDS2	see HLEDS2	-22°F (-30°C) to 284°F (140°C)



- For clamping cable or tubing securely into place.
- Resist corrosion, salt water, weak acids, gasoline, alcohol, oil, grease, and common solvents. (This feature is not assessed by UL certification or testing.)
- All parts are size marked in inches and millimeters.
- Standard material Nylon 6/6. 94V-0 available, consult Heyco.
- For Snap Rivets compatible with Heyco Cable Clamps, see the table on page 7-37.

Heyco® Nylon Cable Clamps

MOUNTING HOLE DIAMETER		SCREW SIZE	PART DIMENSION A		PART NO.		DESCRIPTION			
in.	mm.		in.	mm.	Black	Natural				
Light Duty - 3/8" (9,5 mm) wide, .05" (1,3 mm) thick										
.170	4,3	8	.125	3,2	3362	3312	CCL 125-170			
			.187	4,7	3363	3313	CCL 187-170			
			.250	6,3	3364	3314	CCL 250-170			
			.312	7,9	3365	3315	CCL 312-170			
			.375	9,5	3366	3316	CCL 375-170			
			.437	11,1	3367	3317	CCL 437-170			
.203	5,2	10	.500	12,7	3368	3318	CCL 500-170			
			Heavy Duty - 1/2" (12,7 mm) wide, .06" (1,5 mm) thick							
			.203	5,2	10	.125	3,2	3372	3322	CCH 1/8
						.187	4,7	3373	3323	CCH 3/16
						.250	6,3	3374	3324	CCH 1/4
						.312	7,9	3375	3325	CCH 5/16
.375	9,5	3376				3326	CCH 3/8			
.437	11,1	3377				3327	CCH 7/16			
.500	12,7	3378				3328	CCH 1/2			
.562	14,3	3379				3329	CCH 9/16			
.625	15,9	3380				3330	CCH 5/8			
.687	17,4	3381				3331	CCH 11/16			
.750	19,1	3382				3332	CCH 3/4			
.812	20,6	3383				3333	CCH 13/16			
.875	22,2	3384				3334	CCH 7/8			
1.000	25,4	3390				3340	CCH 1			
1.125	28,6	3392				3342	CCH 1-1/8			
1.187	30,1	3393				3343	CCH 1-3/16			
1.250	31,8	3394				3344	CCH 1-1/4			
1.375	34,9	3396				3346	CCH 1-3/8			
1.500	38,1	3398				3348	CCH 1-1/2			

Standard colors black and natural.

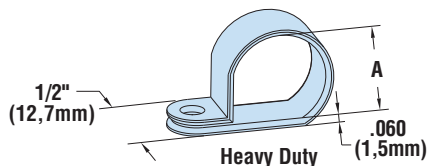
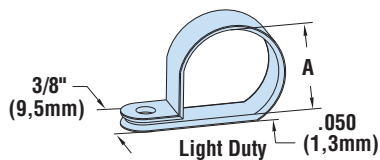

Quick Specs

Material	Nylon 6/6
Certifications	Recognized under the Component Program of Underwriters' Laboratories File E54523
Flammability Rating	94V-2
Temperature Range	32°F (0°C) to 221°F (105°C) - Black 32°F (0°C) to 185°F (85°C) - Natural

Heyco® Lockit™ Nylon Cable Clamps

Lock onto Wire and Cable for Faster Final Assembly

Heavy Duty - 1/2" (12,7 mm) Wide, .06" (1,5 mm) Thick

MOUNTING HOLE DIAMETER		SCREW SIZE	PART DIMENSION A		PART NO.		DESCRIPTION
in.	mm.		in.	mm.	Black	Natural	

Push Lock Style For Panels up to .125" (3,2 mm) thick

MOUNTING HOLE DIAMETER		SCREW SIZE	PART DIMENSION A		PART NO.		DESCRIPTION
in.	mm.		in.	mm.	Black	Natural	
.187	4,7	Push Mount	1.00	25,4	3727	3727N	PLCC 1000
			1.13	28,6	3730	3731	PLCC 1125
			1.19	30,1	3734	3735	PLCC 1187
			1.25	31,8	3738	3739	PLCC 1250
			1.38	34,9	3742	3743	PLCC 1375
			1.50	38,1	3746	3747	PLCC 1500

Snap Lock Style

MOUNTING HOLE DIAMETER		SCREW SIZE	PART DIMENSION A		PART NO.		DESCRIPTION
in.	mm.		in.	mm.	Black	Natural	
.190	4,8	#10	1.00	25,4	3725	3726	SLCC 1000
			1.13	28,6	3728	3729	SLCC 1125
			1.19	30,1	3732	3733	SLCC 1187
			1.25	31,8	3736	3737	SLCC 1250
			1.38	34,9	3740	3741	SLCC 1375
			1.50	38,1	3744	3745	SLCC 1500

Standard colors black and natural.

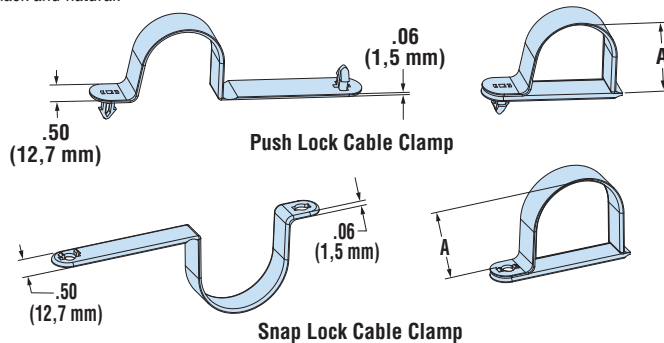

Material	Nylon 6/6
Flammability Rating	94V-2
Temperature Range	32°F (0°C) to 221°F (105°C) - Black 32°F (0°C) to 185°F (85°C) - Natural

Snap Rivet Table - for use with Heyco® Nylon Cable Clamps

For our complete line of Snap Rivets, see pages 7-76 & 7-77

PANEL THICKNESS				PART NO.			DESCRIPTION
Minimum		Maximum		Black	White	V-0 Black	
in.	mm.	in.	mm.				

For .170" (4,3 mm) Mounting Hole, Light Duty Cable Clamps

.08	2,0	.12	3,0	9062	9063	9062F	PR 161-177
.12	3,0	.16	4,1	9064	9065	9064F	PR 161-217
.16	4,1	.20	5,1	9066	9067	9066F	PR 161-256
.20	5,1	.24	6,1	9068	9069	9068F	PR 161-295
.25	6,4	.31	7,9	9318	9319	9318F	PR 161-354
.39	9,9	.45	11,4	9320	9321	9320F	PR 161-492

For .203" (5,2 mm) Mounting Hole, Light or Heavy Duty Cable Clamps

.06	1,5	.10	2,5	9076	9077	9076F	PR 201-177
.10	2,5	.14	3,6	9078	9079	9078F	PR 201-217
.14	3,6	.18	4,6	9080	9081	9080F	PR 201-256
.18	4,6	.22	5,6	9082	9083	9082F	PR 201-295



Push Lock Style

- Push-in “arrowhead” locks part onto cable quickly and easily, for faster final assembly requiring **no additional hardware**.
- Resist corrosion, salt water, weak acids, grease, and common solvents.

Snap Lock Style

- Locking feature allows for preassembly onto cable quickly and easily, for faster final assembly.
- Lock securely but can be **removed and reused**.
- Resist corrosion, salt water, weak acids, grease, and common solvents.
- Standard Material Nylon 6/6. 94V-0 available. Consult Heyco.

Quick Specs



"Stay Connected" with



HEYware

a PennEngineering® Company



- Ideal for securing, insulating, and routing cable and tubing.
- Cable and wire can be installed or removed for repair without removing clamp.
- Mounts with screws, mounting buttons or rivets.

Heyco® Nylon Wire Harness Clamps

MOUNTING HOLE DIAMETER	SCREW SIZE	PART DIMENSIONS						PART NO.	DESCRIPTION	STYLE
		A Bundle Dia.		B Overall Length		C Width				
in. mm.		in.	mm.	in.	mm.	in.	mm.	Natural		

Snap Mouth *

.157	4,0	#8	.50	12,7	1.18	30,0	.39	10,0	4127	WHCX 500	1	NEW!
			.71	18,0	1.38	35,1	.50	12,7				

Open Mouth

.157	4,0	#8	.13	3,2	.77	19,5	.34	8,5	4149	WHC 125	2	NEW!		
			.25	6,4	.83	21,0	.39	10,0					4126	WHCX 250
.205	5,2	#10	.25	6,4	.86	21,8	.41	10,4	4150	WHC 250	3			
			.38	9,0	.83	21,0	.40	10,2					4151	WHC 375
			.50	12,5	1.16	29,4	.40	10,2					4152	WHC 500
			.63	15,9	1.13	28,6	.50	12,7					4153	WHC 625
			.75	19,1	1.28	32,5	.50	12,7					4154	WHC 750
			.95	25,1	1.50	38,1	.50	12,7					4210	WHC 1000
			1.50	38,1	2.12	53,9	.50	12,7	4211	WHC 1500				

Standard color natural.

*Bundle Diameter in closed position.

†No reinforcing ribs on Part No. 4126.

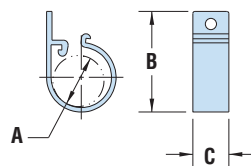

Style 1

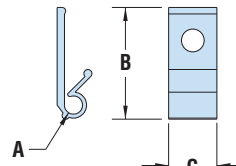

Style 2

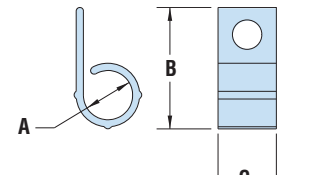

Style 3

Heyco® Nylon Lockit™ Hose Clamps

EFFECTIVE CLAMP RANGE				PART NO.	DESCRIPTION	PART DIMENSIONS			
Minimum Diameter		Maximum Diameter				A Clamp Thickness	B Strap Thickness		
in.	mm.	in.	mm.	Black	in.	mm.	in.	mm.	

LHC Series

.34	8,7	.41	10,3	2388	LHC 344	.25	6,4	.08	2,0
.53	13,5	.59	15,1	2391	LHC 531				
.67	17,0	.81	20,6	2393	LHC 672				

Standard color black.

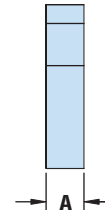
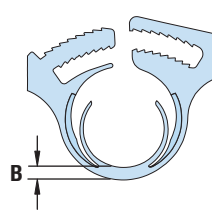

- Retainer clip allows clamp to be pre-positioned on hose before final installation.
- Double row of teeth for more secure grip.
- Quick and easy installation. Tighten instantly with hand pliers or Air Tool (on page 7-39).
- Reusable. Can be removed without cutting.
- Supertough nylon clamps offer additional clamping strength.
- Outlast tubing under pressure.
- Non-conductive and non-magnetic.
- No moving pieces to seize or vibrate loose.
- Maximum Pressure Rating: 200 PSI.

Quick Specs

	WHCX & WHC	LHC
Material	Nylon 6/6	Nylon 6/6 Supertough
Flammability Rating	94V-2	94HB
Temperature Range	32°F (0°C) to 185°F (85°C)	32°F (0°C) to 185°F (85°C)

"Stay Connected" with



HEYware

a PennEngineering® Company



Heyco® Nylon Hose Clamps

EFFECTIVE CLAMP RANGE				PART NO.			DESCRIPTION	PART DIMENSIONS			
Minimum Diameter		Maximum Diameter		6/6 NYLON		GF* NYLON		A		B	
in.	mm.	in.	mm.	Black	White	Black	in.	mm.	in.	mm.	
Regular Style											
.25	6,4	.31	7,9	—	—	2302	HC 250	.13	3,2	.04	1,0
.34	8,7	.41	10,3	2306	2307	2308	HC 344	.21	5,3	.07	1,8
.41	10,3	.47	11,9	2310	2311	2312	HC 406				
.47	11,9	.53	13,5	2314	2315	2316	HC 468				
.53	13,5	.59	15,1	2318	2319	2320	HC 531				
.59	15,1	.66	16,7	2322	2323	2324	HC 593				
.67	17,1	.81	20,6	2326	2327	2328	HC 672				
.75	19,1	.88	22,2	2330	2331	2332	HC 750				
.88	22,2	1.00	25,4	2334	2335	2336	HC 875				
.95	24,1	1.09	26,2	2338	2339	2340	HC 953				
1.03	26,2	1.19	30,2	2342	2343	2344	HC 1031				
1.25	31,8	1.44	36,5	2346	2347	2348	HC 1250				
1.41	35,7	1.63	41,3	2350	2351	2352	HC 1406	.36	9,1		
1.59	40,4	1.81	46,0	2354	2355	2356	HC 1593				
1.69	42,9	1.91	48,4	2358	2359	2360	HC 1687				
1.88	47,6	2.13	54,0	2362	2363	2364	HC 1875	.40	10,2		
2.13	54,0	2.38	60,3	2366	2367	2368	HC 2.125				
Strap Mate Style											
2.25	57,1	2.88	73,0	-	-	2377	HC 2.25	.44	11,2	.08	2,0
2.75	69,8	3.63	92,1	-	-	2380	HC 2.75				
3.50	88,9	4.25	108,0	-	-	2383	HC 3.5				
4.00	101,6	5.00	127,0	-	-	2386	HC 4.0				

Standard colors 6/6 nylon black and white. Glass filled nylon standard color is black.

*HC 250 features a single tang design in glass-filled nylon only.

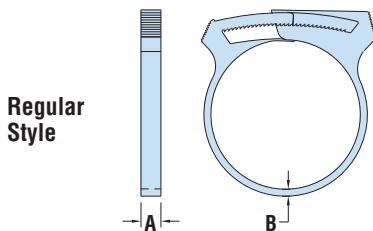

Regular Style

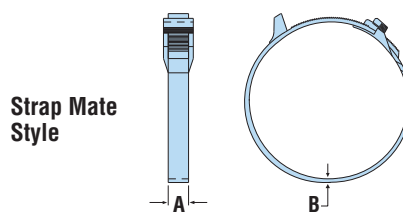

Strap Mate Style

Heyco® Pneumatic Air Tool for Nylon Hose Clamps

For Lockit and Regular Style Hose Clamps only

AIR TOOL PART NO. INCLUDING JAWS	JAW PART NO.*	
	Upper	Lower
0170	0T83	0T84

*Jaw Part No. if purchased separately.

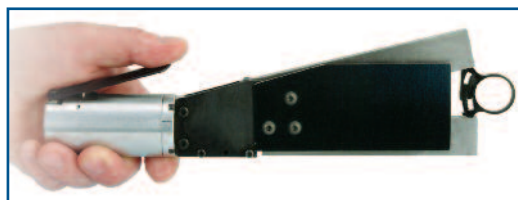

Materials	Nylon 6/6 or glass-filled Nylon
Flammability Rating	94V-2 for 6/6 Nylon, 94HB for glass-filled Nylon
Temperature Range	32°F (0°C) to 221°F(105°C)

- **Quick and easy installation.** Tighten instantly with hand pliers or Air Tools.
- **Reusable.** Can be removed without cutting.
- Glass-filled nylon clamps offer additional clamping strength.
- Outlast tubing under pressure.
- Lightweight yet resist corrosion, salt water, weak acids, grease, and common solvents.

Available in Small Packs

NEW

PART NO.	DESCRIPTION	QTY
2307-P	HC 344 WHITE 20PK	20
2311-P	HC 406 WHITE 20PK	
2315-P	HC 468 WHITE 20PK	
2319-P	HC 531 WHITE 20PK	
2323-P	HC 593 WHITE 20PK	
2327-P	HC 672 WHITE 20PK	
2331-P	HC 750 WHITE 20PK	
2335-P	HC 875 WHITE 20PK	
2339-P	HC 953 WHITE 20PK	
2343-P	HC 1031 WHITE 20PK	
2347-P	HC 1250 WHITE 20PK	
2351-P	HC 1406 WHITE 20PK	

- Allows for a **semi-automated process** which increases speed over manual tools.
- Activated by hand lever reducing stress on the hand and the risk of carpal tunnel syndrome associated with repetitive assembly.
- Maximum Pressure Rating: 125 psi
- Adjustable jaws allow tool to accommodate a wide range of Heyco Hose Clamps.
- Operates only when lever is depressed.
- Tool operates on standard shop air.



- Interlocking surfaces prevent the cable clamp from separating when installing the mounting screw.
- Easily guide and locate wires and cables.
- Designed with rounded edges to prevent chaffing and cutting wire insulation.

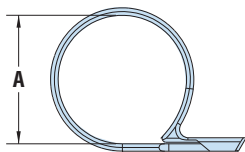

CCSA Series

Heyco® Self-Aligning Nylon Cable Clamps

MOUNTING HOLE DIAMETER		SCREW SIZE		PART DIMENSION A		PART NO.		DESCRIPTION
in.	mm.			in.	mm.	Black	Natural	
.390" (9,9 mm) Wide, .04" (1,0 mm) Thick								
.187	4,7	10	.125	3,2	13050B	13050	CCSA 1/8	
			.187	4,7	13051B	13051	CCSA 3/16	
			.250	6,3	13052B	13052	CCSA 1/4	
			.312	7,9	13053B	13053	CCSA 5/16	
			.375	9,5	13054B	13054	CCSA 3/8	
.500	12,7			13056B	13056	CCSA 1/2*		
.500" (12,7 mm) Wide, .06" (1,5 mm) Thick								
.187	4,7	10	.625	15,9	13058B	13058	CCSA 5/8	
			.750	19,1	13060B	13060	CCSA 3/4	
			1.000	25,4	13062B	13062	CCSA 1	

Standard colors black and natural.

*.06" (1,5 mm) Thick



Heyco® Hinged Locking Cable Clamps



- Locking hinged design holds cables securely in place while providing strain relief.
- Prevents vibration from disrupting cables.

MAXIMUM BUNDLE DIA.	PANEL THICKNESS RANGE				PART NO.	DESCRIPTION	PART DIMENSIONS						
	Minimum		Maximum				Natural	A Length		B Width		C Height	
	in.	mm.	in.	mm.				in.	mm.	in.	mm.	in.	mm.
.47	12,0	.031	0,8	.047	1,2	12666	CCHL-47-047	1.72	43,7	.47	12,0	1.04	26,5
.59	15,1	.024	0,6	.059	1,5	12665	CCHL-59-059	1.57	39,8	.46	11,8	.94	24,0

Standard color natural.

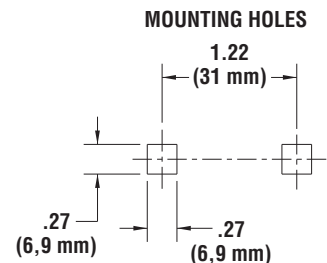
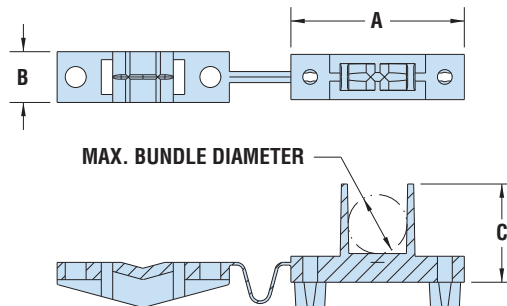

Quick Specs

Material	Nylon 6/6
Flammability Rating	94V-2
Temperature Range	32°F (0°C) to 185°F (85°C)



Heyco® Compression Cable Clamps

WIRE CAPACITY		Pin Count	PART NO. Natural	DESCRIPTION	PART DIMENSIONS					
Volume					A Length	B Width		C Height		
in.	mm.			in.	mm.	in.	mm.	in.	mm.	
Double Arrowhead Mount										
2.11 x .45	53,5 x 11,5	40	12121	CCTF-40A	2.64	67,0	.39	10,0	.63	16,0
Adhesive Back Mount										
1.26 x .45	32,0 x 11,5	30	12124	CCTFA-30	1.77	45,0	.73	18,6	.62	15,8
2.57 x .41	65,2 x 10,5	50	12126	CCTFA-50	3.08	78,3	.74	18,8		

Standard color natural.



- Hinged style allows for easy addition or removal of cables.
- Secures cable into place with easy installation.
- Will not strain cable.

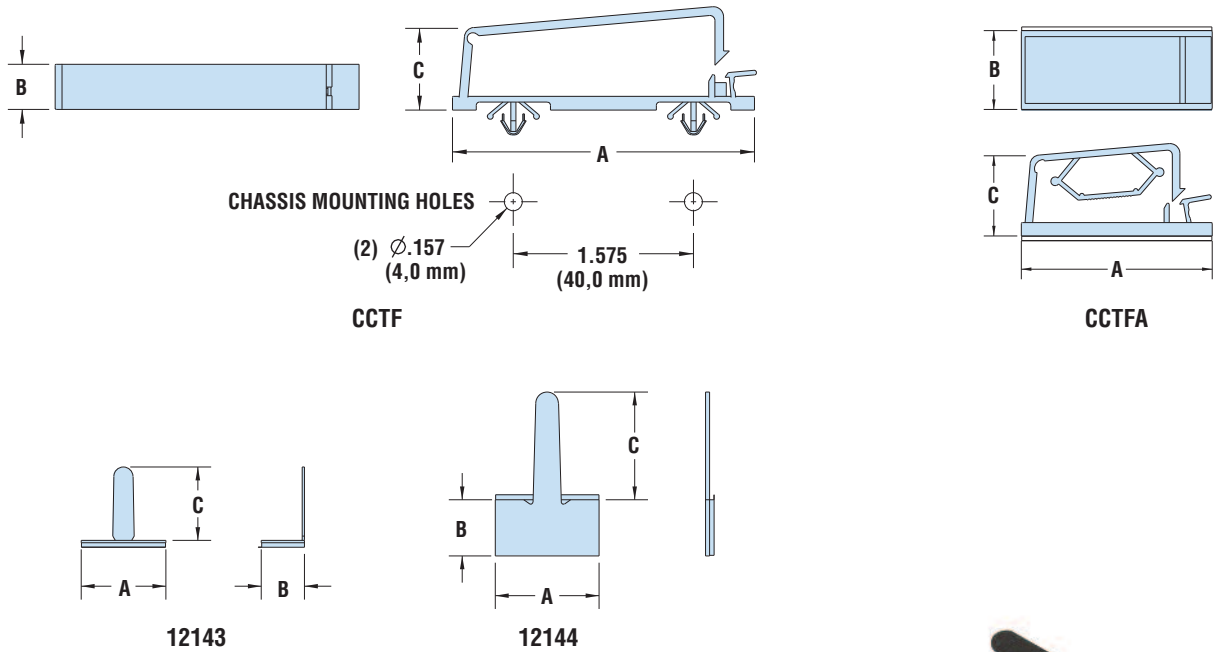

Heyco® Steel Cable Stays

Adhesive Back Mount



Base Length		Base Width		Tongue Length		PART NO.	DESCRIPTION
in.	mm.	in.	mm.	in.	mm.		
.59	15,1	.30	7,7	.52	13,1	12143	CS-5930A
.73	18,5	.39	10,0	.76	19,2	12144	CS-7339A



- Provide a secure, yet simple fastening for cables.
- Adhesive back mount results in a very secure attachment.

Material	Compression Cable Clamps Nylon 6/6	Material	Cable Stays Electrolytic Tin-Plated Steel with 3M Adhesive Tape
Flammability Rating	94V-2	Temperature Range	Application Temperature: 70°F (21°C) to 100°F (38°C)
Temperature Range	32°F (0°C) to 185°F (85°C)		Operating Temperature: -40°F (-40°C) to 176°F (80°C)

"Stay Connected" with



HEYware

a PennEngineering® Company

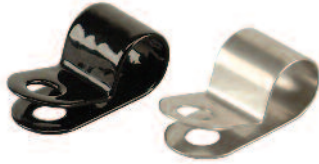

- For clamping cable or tubing securely into place, especially in **harsh environments**.
- Smooth "coined clamp" edges prevent damage to cable insulation.
- Constructed from corrosion resistant 304 stainless steel.
- Coated parts are constructed from 304 stainless steel and coated with polyolefin a thermoplastic co-polymer.
- Coating provides a durable non-toxic, odorless coating that has very good low temperature flexibility and excellent electrical properties. This coating also has **FDA food contact** approval.
- All parts require a .203" (5,2 mm) mounting hole suitable for a #10 screw.
- Not for use in a marine salt water environment. Contact Heyco for alternative materials.
- DFARS Compliant

Heyco® Stainless Steel Cable Clamps

PART DIMENSION A		STANDARD		COATED	
in.	mm.	PART NO.	DESCRIPTION	PART NO.	DESCRIPTION
.19	4,7	S3373	CC H 3/16 SS	S3323	CC H 3/16 SS Coated NEW!
.25	6,3	S3374	CC H 1/4 SS	S3324	CC H 1/4 SS Coated
.38	9,5	S3376	CC H 3/8 SS	S3326	CC H 3/8 SS Coated
.50	12,7	S3378	CC H 1/2 SS	S3328	CC H 1/2 SS Coated
.63	15,9	S3380	CC H 5/8 SS	S3330	CC H 5/8 SS Coated
.75	19,1	S3382	CC H 3/4 SS	S3332	CC H 3/4 SS Coated
.88	22,2	S3384	CC H 7/8 SS	S3334	CC H 7/8 SS Coated

Consult Heyco for additional sizes.

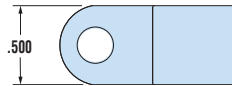

Heyco® Steel Cushion Clamps

MOUNTING HOLE DIA.		SCREW SIZE	PART DIMENSION A		PART NO.	DESCRIPTION
in.	mm.		in.	mm.		
.650" (16,5 mm) Overall Width, .031" (0,8 mm) Steel Thickness						
.265	6,7	1/4	.187	4,7	12300	CCSC L 3/16
			.250	6,3	12301	CCSC L 1/4
			.312	7,9	12302	CCSC L 5/16
			.375	9,5	12303	CCSC L 3/8
			.437	11,1	12304	CCSC L 7/16
			.500	12,7	12305	CCSC L 1/2
			.562	14,3	12306	CCSC L 9/16
			.625	15,9	12307	CCSC L 5/8
			.687	17,4	12308	CCSC L 11/16
			.750	19,1	12309	CCSC L 3/4
			.875	22,2	12310	CCSC L 7/8
			1.000	25,4	12311	CCSC L 1
			1.125	28,6	12312	CCSC L 1-1/8
1.250	31,8	12313	CCSC L 1-1/4			
.750" (19,1 mm) Overall Width, .047" (1,2 mm) Steel Thickness						
.406	10,3	7/16	.250	6,3	12331	CCSC H 1/4
			.312	7,9	12332	CCSC H 5/16
			.375	9,5	12333	CCSC H 3/8
			.437	11,1	12334	CCSC H 7/16
			.500	12,7	12335	CCSC H 1/2
			.625	15,9	12337	CCSC H 5/8
			.687	17,4	12338	CCSC H 11/16
			.875	22,2	12340	CCSC H 7/8
			1.000	25,4	12341	CCSC H 1
			1.250	31,8	12343	CCSC H 1-1/4



- Light to heavy duty steel clamp.
- E.P.D.M. cushion for electrical insulation and vibration absorption.
- Steel clamps are zinc electroplated for corrosion resistance.
- Color - Silver with durable black cushion.

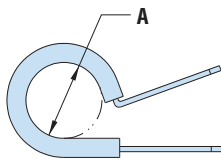

Quick Specs

	CC H	CCSC
Material	304 Stainless Steel	Zinc Plated Steel with an EPDM Sleeve

Heyco® Vinyl Coated Steel Clamps

Screw Mount

PART NO.	DESCRIPTION	PART DIMENSIONS									
		A		B		C		D		Coating Length	
		Overall Length	Flange Diameter	Arm Width	Mounting Hole Dia.	in.	mm.	in.	mm.	in.	mm.
12067	VCSC 087-18	.87	22,1	.32	8,1	.18	4,6	.18	4,6	.47	11,9
12068	VCSC 110-12	1.10	27,9	.32	8,1	.12	3,0	.12	3,0	.71	18,0
12069	VCSC 134-12	1.34	34,0	.24	6,1	.08	2,0	.12	3,0	.94	23,9
12070	VCSC 137-14	1.38	35,1	.32	8,1	.20	5,1	.14	3,6	.98	24,9
12071	VCSC 157-14	1.57	39,9	.32	8,1	.12	3,0	.14	3,6	1.18	30,0
12072	VCSC 177-17	1.77	45,0	.35	8,9	.16	4,1	.17	4,3	1.38	35,1
12073	VCSC 189-12	1.89	48,0	.24	6,1	.08	2,0	.12	3,0	1.57	39,9
12074	VCSC 213-13	2.13	54,1	.24	6,1	.14	3,6	.13	3,3	1.81	46,0
12075	VCSC 213-18	2.13	54,1	.32	8,1	.19	4,8	.18	4,6	1.65	41,9
12076	VCSC 252-17	2.52	64,0	.32	8,1	.20	5,1	.17	4,3	2.09	53,1
12077	VCSC 260-13	2.60	66,0	.31	7,9	.18	4,6	.13	3,3	2.17	55,1
12078	VCSC 299-18	2.99	75,9	.32	8,1	.18	4,6	.18	4,6	2.56	65,0
12079	VCSC 299-28	2.99	75,9	.43	10,9	.20	5,1	.28	7,1	2.44	62,0
12080	VCSC 331-18	3.31	84,1	.32	8,1	.18	4,6	.18	4,6	2.83	71,9
12081	VCSC 496-18	4.96	126,0	.32	8,1	.24	6,1	.18	4,6	4.41	112,0



- Flexible soft steel easily bends and forms to desired shape and holding diameter.
- Vinyl coating both grips and insulates the cable or wire bundle.

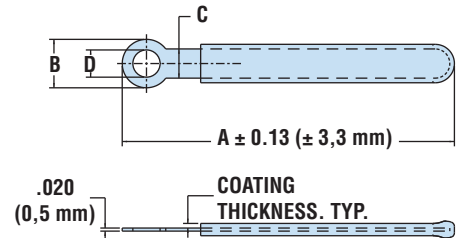

VCSC SCREW MOUNT

Adhesive Back Mount

PART NO.	DESCRIPTION	PACKAGING		PART DIMENSIONS							
		Std. Pack	Small Pack	A		B		C		D	
			†	Arm Length	Arm Width	Base Width	Base Length	in.	mm.	in.	mm.
12082	VCSC 71-08A	5000	10	.71	18,0	.08	2,0	.31	7,9	.35	8,9
12083	VCSC 98-14A	5000	10	.98	24,9	.14	3,6	.55	14,0	.55	14,0
12084	VCSC 157-16A	3000	10	1.57	39,9	.16	4,1	.75	19,1	.79	20,1

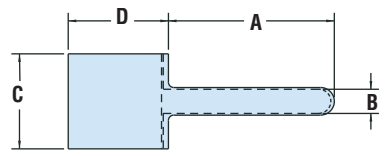

DOUBLE SIDED FOAM TAPE.

VCSC ADHESIVE BACK MOUNT

† To order Small Packs, please add the suffix -P to Part No.; e.g., 12082-P

Spring Clamp



PART NO.	DESCRIPTION	PART DIMENSIONS							
		A		B		C		D	
		Length	Clamping Height	Clamping Length	Mounting Hole	in.	mm.	in.	mm.
12710	VCSP-161-09	1.61	40,9	.09	2,3	1.19	30,2	.156	4,0
12711	VCSP-263-09	2.63	66,8	.09	2,3	2.24	56,9		

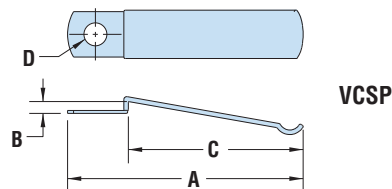

- This vinyl coated spring steel clamp secures round cable, ribbon cable and tubing.
- Vinyl coating protects and insulates.
- Mounts with a #6 (M3.5) screw, yet cable can be inserted and removed without removing the clip.

Material VCSC Body: Soft steel, electrogalvanized .02" (0,5 mm) thick
 VCSP Body: Stainless steel, w/vinyl coating .02" (0,5 mm) thick
 Coating: Soft, PVC, .032" (0,8 mm) minimum thickness

Quick Specs

“Coined”
edges prevent
cable damage



- Heyco’s SunRunner and SunRunner EZ’s robust “double-compression” design securely holds from (1) 12 gauge USE-2 to (2) 10 gauge PV-1000V solar wires.
- Also for use with other cables from .20” (5,1 mm) to .33” (8,3 mm) in diameter.
- Heyco SunRunner Clips are designed to provide a better method for PV module wire management **and may be used wherever single or multiple cable management is needed.**
- Smooth clip edges prevent damage to cable insulation.
- Locking tabs securely fasten clips to module extrusions, **or other panels.**
- Screwdriver slot for easy removal or movement of clips if necessary.
- Neatly dresses cables on PV panel frames or along mounting channels.
- Constructed from corrosion resistant 304 stainless steel, not for use in a marine salt water environment.
- 316 stainless steel now available for marine and other harsh environments.
- **SunRunner Vidrio™ is designed to mount directly onto the glass panel with compression force only.** Will not harm the glass surface, and the black color meets many HOA requirements!
- The TPE coating on the SunRunner Vidrio™ provides an electrically insulated surface.
- **SunRunner EZ’s are designed for thicker module frames** as well as racking – accommodates profiles up to .250” (6,4 mm) thick!
- **SunRunner 4 designed to hold up to (4) 12 gauge USE-2 or (4) 10 gauge PV-1000V solar wires.**
- SunRunner 4 is constructed from heat treated 410 stainless steel for excellent strength and corrosion protection for outdoor exposure.
- DFARS Compliant.



HEYClip™ SunRunner® Cable Clips

Double-Compression, Straight-thru Design

PANEL THICKNESS CLAMPING RANGE				WIRE DIA. RANGE	PART NO.		DESCRIPTION	FOOTPRINT		OVERALL HEIGHT	
Minimum	Maximum				304	316		A x B		C	
in.	mm.	in.	mm.		Stainless	Stainless	in.	mm.	in.	mm.	
1-2 Wires - SunRunner Clip for panels up to .090” (2,3 mm) thick											
.06	1,4	.09	2,3	.20” (5,1 mm)- .33” (8,3 mm) each cable	S6405	S6490	SunRunner® Clip 100 Pack	.97 x .50	24,6 x 12,7	.39	9,9
					S6445	S6495	SunRunner® Clip Bulk				
1-2 Wires - SunRunner Vidrio™ Clip for GLASS panels up to .090” (2,3 mm) thick NEW PRODUCTS											
.13	3,2	.25	6,4	.20” (5,1 mm)- .33” (8,3 mm) each cable	S6460	-	SunRunner® Vidrio™ Clip 100 Pack	.99 x .52	25,1 x 13,2	.45	11,4
					S6500	-	SunRunner® Vidrio™ Clip Bulk				
1-2 Wires - SunRunner EZ Clip for panels up to .250” (6,4 mm) thick											
.09	2,3	.25	6,4	.20” (5,1 mm)- .33” (8,3 mm) each cable	S6407	-	SunRunner® EZ Clip 100 Pack	.97 x .50	24,6 x 12,7	.41	10,4
					S6447	-	SunRunner® EZ Clip Bulk				
4 Wires - SunRunner 4 Clip for panels up to .125” (3,2 mm) thick											
.06	1,4	.13	3,2	.20” (5,1 mm)- .30” (7,6 mm) each cable*	S6443	-	SunRunner® 4 Clip 100 Pack	1,34 x .50	33,8 x 12,7	.36	9,1
					S6483	-	SunRunner® 4 Clip Bulk				
4 Wires - SunRunner 4 EZ Clip for panels up to .250” (6,4 mm) thick											
.13	3,2	.25	6,4	.20” (5,1 mm)- .30” (7,6 mm) each cable*	S6400	-	SunRunner® 4 EZ Clip 100 Pack	1,33 x .50	33,8 x 12,7	.36	9,1
					S6440	-	SunRunner® 4 EZ Clip Bulk				

*Can accommodate up to three .33” (8,3 mm) diameter cables.

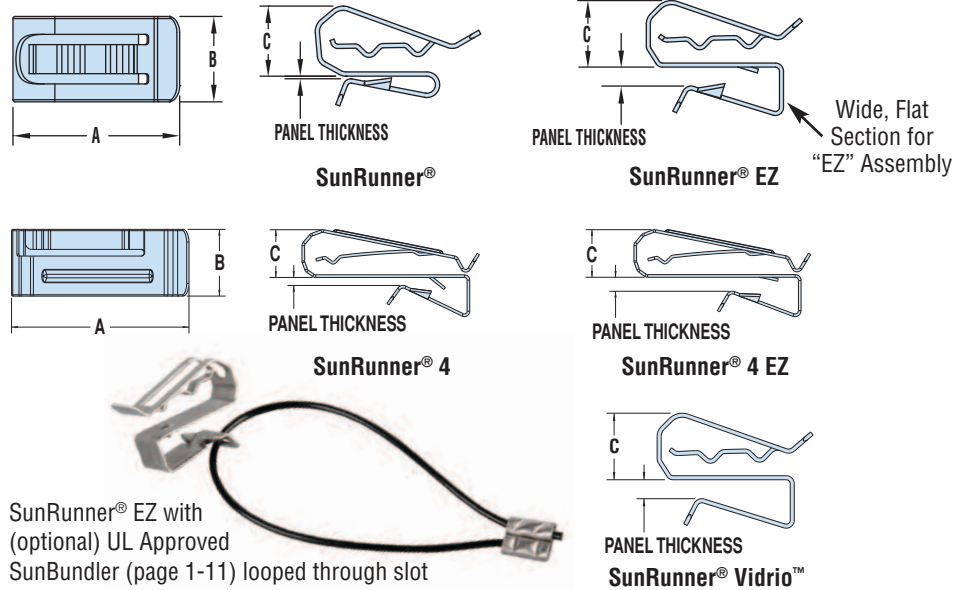

Material	.025” thick 304 or 316 stainless steel (SunRunner and SunRunner EZ) .020” thick 410 stainless steel (SunRunner 4 and SunRunner 4 EZ)
Certifications	Certified by UL for Compliance with both Canadian and US Requirements under File E54523
Temperature Range	-40°F (-40°C) to 572°F (300°C)

“Stay Connected” with



HEYware

a PennEngineering® Company

HEYClip™ SunRunner® 90° Cable Clips

Double-Compression, Right Angle Design

PANEL THICKNESS CLAMPING RANGE				WIRE DIA. RANGE Maximum	PART NO.	DESCRIPTION	FOOTPRINT		OVERALL HEIGHT	
Minimum	Maximum						A x B		C	
in.	mm.	in.	mm.				in.	mm.	in.	mm.
Single Wire Clip for panels up to .125" (3,2 mm) thick										
.06	1,4	.13	3,2	.20" (5,1 mm)- .33" (8,3 mm) each cable	S6406	SunRunner® 90° Clip 100 Pack	.82 x .78	20,8 x 19,8	.39	9,9
					S6446	SunRunner 90° Clip Bulk				
Double Wire Clip for panels up to .125" (3,2 mm) thick NEW PRODUCTS										
.06	1,4	.13	3,2	.20" (5,1 mm)- .33" (8,3 mm) each cable	S6436	SunRunner® 90°-2 Clip 100 Pack	.65 x .98	16,5 x 24,9	.39	9,9
					S6476	SunRunner® 90°-2 Clip Bulk				
Four Wire Clip for panels up to .125" (3,2 mm) thick NEW PRODUCTS										
.06	1,4	.13	3,2	.20" (5,1 mm)- .30" (7,6 mm) each cable*	S6439**	SunRunner® 90°-4 Clip 100 Pack	.56 x 1.63	14,2 x 41,4	.36	9,1
					S6479**	SunRunner® 90°-4 Clip Bulk				

*Can accommodate up to three .33" (8,3 mm) diameter cables.

**SunRunner 90-4 parts are not cULus

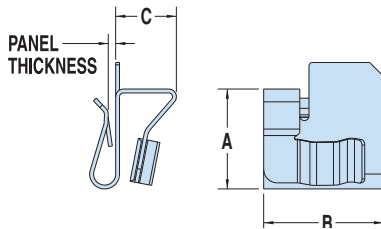

SunRunner® 90°

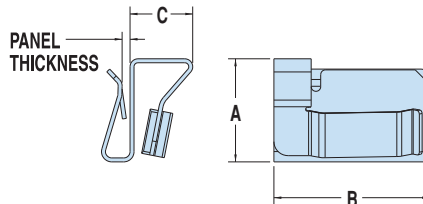

SunRunner® 90-2

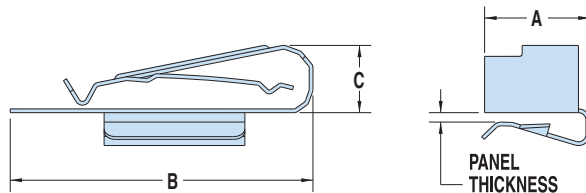

SunRunner® 90-4

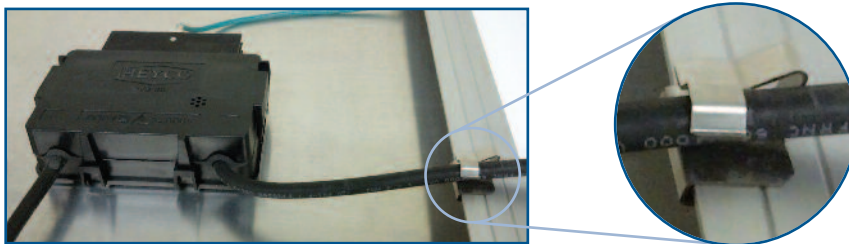

- SunRunner 90° Cable Clips are designed to mount at a 90° angle to the original SunRunner®.
- The SunRunner 90° will accommodate a single cable from .20" (5,1 mm) to .33" (8,3 mm); SunRunner 90-2 will accommodate (2) of these cables; SunRunner 4 will accommodate (4) cables from .30" (7,6 mm) to .20" (5,1 mm).
- SunRunner 90° Series is designed for use with PV modules mounted in the "landscape" mode. PV modules with shorter than normal junction box cables cannot be dressed out to the sides of the module. The SunRunner 90° Series will also allow the junction box cables to be run to the adjacent modules across the short side of the PV module frame.
- Not for use in a marine salt water environment. Contact Heyco for alternative materials.
- DFARS Compliant.



Material .020" thick heat treated 410 stainless steel (SunRunner 90-4)
.025" thick 304 stainless steel (SunRunner 90° and SunRunner 90-2)

Certifications Certified by UL for Compliance with both Canadian and US Requirements under File E54523

Quick
Specs

"Stay Connected" with



HEYware

a PennEngineering® Company

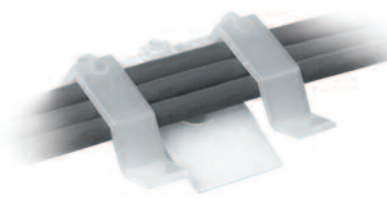

HEYClip™ Tension Wire Clips - Nylon Adhesive-Back Mount

- Gather and direct cables singly or in groups smaller than those accommodated by other Heyco Wire Holders.
- Part No. 3639 (WCA-5) may also be screw mounted. #8 screws not included.
- Apply to a clean, dry surface.

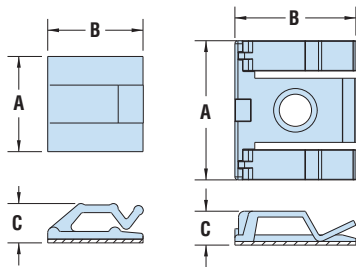

Style 1

Style 2

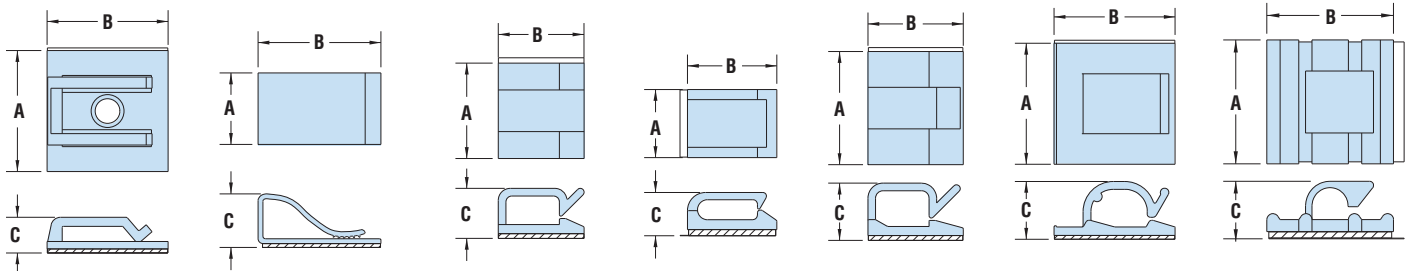

Style 3

Style 4

Style 5

Style 6

Style 7

Style 8

Style 9

WIRE CAPACITY				PART NO.	DESCRIPTION	RELEASE TAB?	PART DIMENSIONS						STYLE
Length		Width					Natural *	A		B		C	
in.	mm.	in.	mm.		in.	mm.		in.	mm.	in.	mm.		
.13	3,2	.25	6,4	3638	WC A-4	no	.63	15,9	.63	15,9	.25	6,4	1
.13	3,2	.50	12,7	3639	WC A-5 **	no	1.15	29,2	1.00	25,4	.28	7,1	2
.12	3,0	.62	15,8	3649	TCN3-801 **	yes	1.00	25,4	1.00	25,4	.29	7,4	3
.25	6,4	.88	22,4	12950	TCN4-804 Gray	yes	.59	15,0	1.02	25,8	.41	10,3	4
				12951	TCN4-805	yes							
.24	6,0	.19	4,7	12953	TCN5-2419	yes	.63	16,0	.45	11,4	.32	8,1	5
.31	8,0	.19	4,7	12954	TCN5-3119	yes	.63	16,0	.53	13,4	.32	8,1	
.32	8,2	.20	5,2	12955	TCN5-3220	yes	.63	16,0	.15	14,4	.34	8,7	
.35	9,0	.19	4,8	12956	TCN5-3519	yes	.63	16,0	.57	14,4	.33	8,3	
.35	9,0	.20	5,2	12957	TCN5-3520	yes	.55	14,0	.51	13,0	.34	8,7	
.40	10,2	.26	6,7	12959	TCN5-4026	yes	.63	16,0	.67	16,9	.40	10,2	
.17	4,3	.10	2,5	12961	TCN6-1710	yes	.39	10,0	.37	9,5	.23	5,9	6
.25	6,3	.10	2,5	12962	TCN6-2510	yes	.47	12,0	.37	9,5	.25	6,3	
.33	8,4	.10	2,5	12963	TCN6-3310	yes	.49	12,5	.37	9,5	.24	6,0	
.32	8,2	.10	2,5	12964	TCN6-3210	yes	.50	12,7	.50	12,7	.25	6,3	
.41	10,3	.10	2,5	12965	TCN6-4110	yes	.57	14,5	.37	9,5	.25	6,4	
.46	11,6	.12	3,1	12966	TCN6-4612	yes	.66	16,7	.51	13,0	.26	6,6	
.31	7,9	.24	6,0	12968	TCN7-3124	yes	.59	14,9	.75	19,0	.37	9,5	7
.35	9,0	.24	6,0	12969	TCN7-3524	yes	.63	16,0	.75	19,0	.37	9,5	
.46	11,8	.31	7,9	12971	TCN7-4631	yes	.75	19,0	.75	19,0	.46	11,8	
.54	13,7	.33	8,3	12972	TCN7-5433	yes	.82	20,9	.75	19,0	.48	12,1	
				3629	WC A-43	no	.63	15,9	.63	15,9	.31	7,9	
.22	5,5	.24	6,1	3636	WC A-44	no	.63	15,9	.63	15,9	.38	9,5	8
.35	8,9	.36	9,1	3637	WC A-46	yes	.75	19,1	.75	19,1	.50	12,7	
.46	11,7	.31	7,9	12974	TCN8-4631	yes	1.00	25,4	.61	15,6	.48	12,2	
.46	11,8	.31	7,9	12975	TCN8-4631-1	yes	1.00	25,4	1.00	25,4	.48	12,1	
				3628	WC A-42	no	.61	15,5	.61	15,5	.28	7,1	

* Standard color natural except Part No. 12950 color is Gray.

** Part Nos. 3639 and 3649 may also be #8 (M4) screw mounted.

Quick Specs

Material	Nylon 6/6
Flammability Rating	94V-2
Temperature Range	-40°F (-40°C) to 185°F (85°C)
	Adhesive-Back: 1/16" (1,6 mm)
Temperature Range	32°F (0°C) to 185°F (85°C)

“Stay Connected” with



HEYware

a PennEngineering® Company

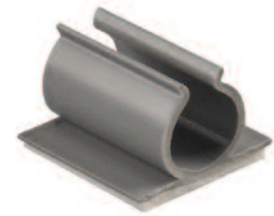

HEYClip™ Tension Wire Clips - Vinyl U Style

Adhesive-Back Mount

MAXIMUM BUNDLE DIAMETER A		PART NO. Gray	DESCRIPTION	PACKAGING		OVERALL HEIGHT D*		FOOTPRINT**	
in.	mm.			Std. Pack	Small Pack †	in.	mm.	B x C	
WCUA Series									
.13	3,2	3335	WCUA 125	5000	25	.29	7,4	.75 x .75	19,1 x 19,1
.25	6,4	3336	WCUA 250	5000	25	.47	11,9		
.38	9,5	3337	WCUA 375	5000	25	.59	15,1	1.00 x 1.00	25,4 x 25,4
.50	12,7	3338	WCUA 500	5000	10	.61	15,5		
.56	14,3	3339	WCUA 562	1000	10	.64	16,3		
.75	19,1	3341	WCUA 750	1000	10	.90	22,9		
WCDA Series									
NEW PRODUCT!									
.25	6,4	3821	WCDA 250	5000	25	.40	10,2	.50 x .50	12,7 x 12,7
.50	12,7	3822	WCDA 500	3000	25	.73	18,5	.75 x .75	19,1 x 19,1
.75	19,1	3823	WCDA 750	3000	10	1.02	25,9	1.13 x 1.00	28,7 x 25,4
1.00	25,4	3824	WCDA 1000	1000	10	1.30	33,0	1.50 x 1.25	38,1 x 31,8

Standard color gray.

* At maximum wire capacity.

** Custom lengths available by special order, consult Heyco.

† To order Small Packs, please add the suffix -P to Part No.; e.g., 3335-P.

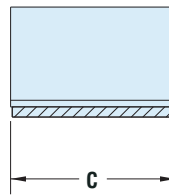
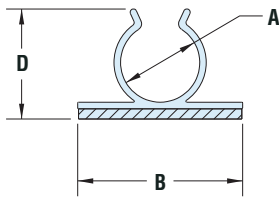

WCUA

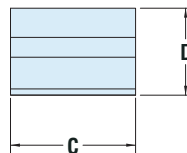
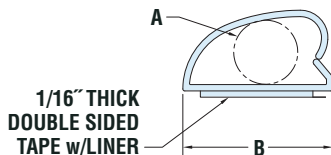

WCDA

Material	PVC
Flammability Rating	94V-0
Temperature Range	-20°F (-29°C) to 150°F (66°C)

Quick
Specs

“Stay Connected” with



HEYware

a PennEngineering® Company



HEYClip™ MaxRunner® Cable Clip Arrays

Clip Mount or Flush Mount with Screws, accommodates up to **12 Cables**

- **Hold up to 12 cables** with wire diameters ranging from .20" (5,2 mm) to .28" (7,2 mm).
- Patented design is the ultimate multiple strand wire management.
- Molded internal locking tabs securely hold the cables in place preventing side-to-side movement or slippage of the cables.
- Constructed from PPE+PS flame retardant “Noryl” material with a V-0 flame rating and a UV (f1) rating for excellent resistance to outdoor exposure.
- **Clip Mount** features a versatile, 301 stainless steel mounting clip.
- Clip is designed to secure the holder to a wide variety of aluminum extruded mounting rails of various profiles with thicknesses up to .250" (6,4 mm).
- **Flush Mount** designed to mount on flat panels or extrusions without mounting ledges.
- Easily attaches to any flat surface with four mounting screws.
- Recommended spacing is 4 feet.
- Load Rating not to exceed 15 lbs.
- US Patent No. 8950712B2

PANEL THICKNESS CLAMPING RANGE		WIRE DIA. RANGE		PART NO.	DESCRIPTION	FOOTPRINT		OVERALL HEIGHT			
Minimum	Maximum	Minimum	Maximum			in.	mm.	in.	mm.		
Clip Mount											
.06	1,5	.25	6,4	.20 - .28	5,2 - 7,2	S6403	MaxRunner 12 Clip Mount	3.00 x 3.13	76,2 - 79,5	.98	24,9
Flush Mount*											
N/A: designed for flat mount				.20 - .28	5,2 - 7,2	S6433	MaxRunner 12 Flush Mount	3.00 x 3.13	76,2 - 79,5	1.00	25,4

*Screws not included

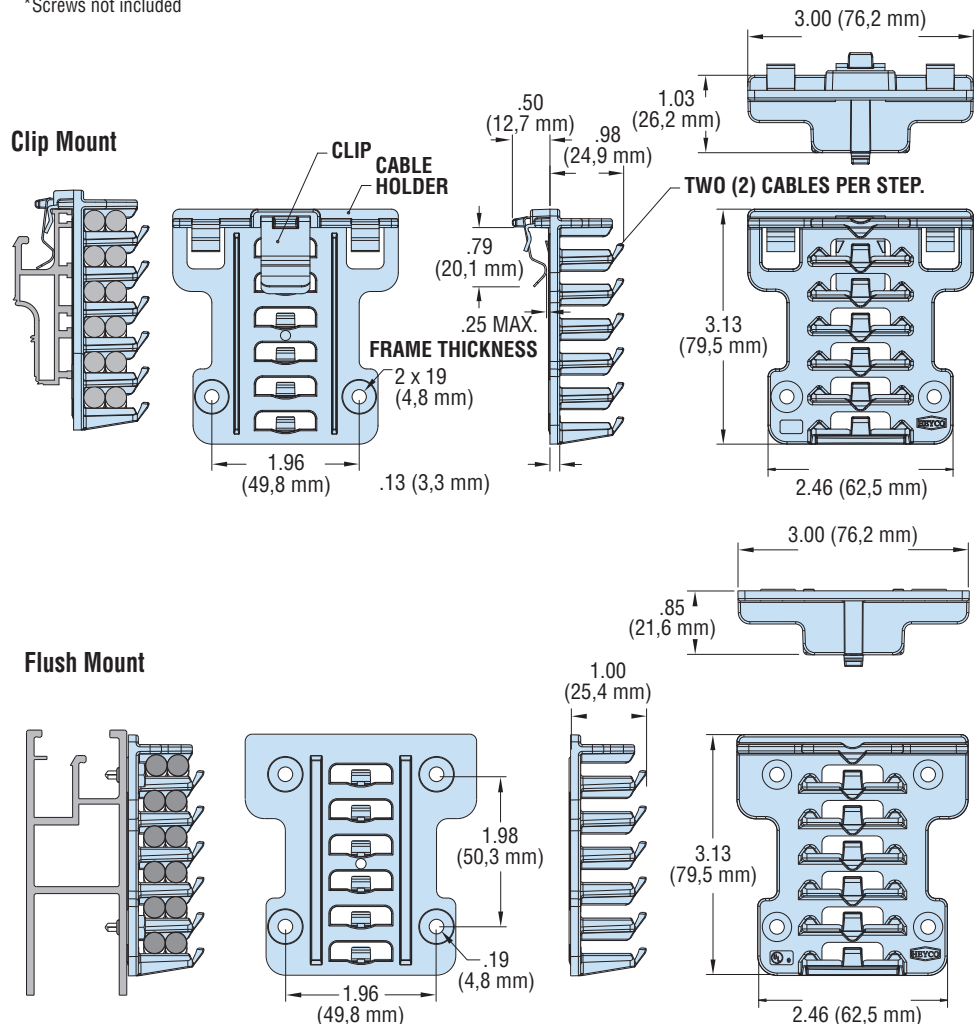

Quick Specs

Materials

Certifications



PPE & PS Noryl (Clip Mount includes a 301 stainless steel mounting clip)
 Certified by UL for Compliance with both Canadian and U.S. requirements under File E54523

Flammability Rating

94V-0

Temperature Range

-40°F (-40°C) to 203°F (95°C)



HEYClip™ Wave Locks

Wave Locks - Standard

BUNDLE DIAMETER RANGE		PART NO. Natural	DESCRIPTION	OVERALL HEIGHT C	
in.	mm.			in.	mm.
WL Series					
.13 - .15	3,2 - 3,8	12085	WL 125	.48	12,2
.16 - .24	4,1 - 6,1	12086	WL 200	.82	20,7
.20 - .30	5,1 - 7,6	12087	WL 250	.91	23,0
.30 - .40	7,6 - 10,2	12088	WL 350	1.03	26,2
.70 - .80	17,8 - 20,3	12091	WL 750	1.52	38,6

NEW!

- Part Description Key: WL XXX, where XXX = Average Bundle Diameter (inches).
- Barreled ends for greater holding power.
- Smooth rounded edges won't cut into cable's insulations - or installer's hand.
- Locking ends twist into place with fingertip pressure.

Standard color natural.

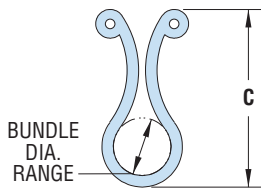

Wave Locks-Standard

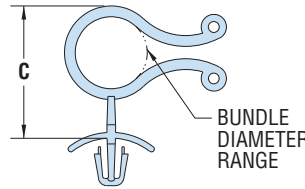

Wave Locks-Arrowhead



Wave Locks - Side Entry - Arrowhead Mount

BUNDLE DIAMETER RANGE		PART NO. Natural	DESCRIPTION	OVERALL HEIGHT C	
in.	mm.			in.	mm.
WL-90 Series For .063" (1,6 mm) thick panels					
.50 - .60	12,7 - 15,2	12094	WLS 550-90	.90	22,8

Standard color natural. Natural 94V-0 material available, consult Heyco.

- Part Description Key: WLS XXX-90, where XXX = Average Bundle Diameter (inches).
- .187" (4,8 mm) diameter mounting hole.

Wave Locks - Adhesive Back Mount

MAXIMUM BUNDLE DIAMETER		PART NO. Natural	DESCRIPTION	PACKAGING		OVERALL HEIGHT C	
in.	mm.			Std. Pack	Small Pack †	in.	mm.
WL-A Series							
.30 - .40	7,6 - 10,2	12096	WL 350A	5000	25	1.10	27,9
.40 - .50	10,2 - 12,7	12097	WL 450A	5000	25	1.26	32,0
.70 - .80	17,8 - 20,3	12098	WL 750A	5000	25	1.61	40,9

Standard color natural.

† To order Small Packs, please add the suffix -P to Part No.; e.g., 12096-P.

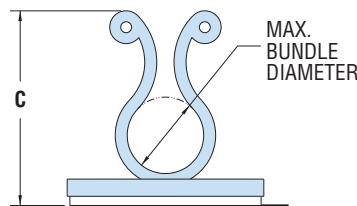

Wave Locks-Adhesive

- Part Description Key: WL XXXA, where XXX = Average Bundle Diameter (inches).



Material	Nylon 6/6
Flammability Rating	94V-2
Temperature Range	32°F (0°C) 185°F (85°C)

Quick Specs

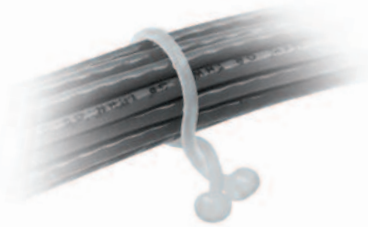

- Barreled ends for greater holding power.
- Smooth, rounded edges ensure that Lockit Clips won't cut into cable's insulation—or the installer's hand.
- Releasable and reusable loops for easy wire bundling.
- Locking ends twist into place with fingertip pressure.
- Part Description Key: LL XXX, where XXX = Maximum Bundle Diameter (inches).

HEYClip™ Lockit™ Loops

Standard Loops

MAXIMUM BUNDLE DIAMETER		PART NO. Natural	DESCRIPTION	OVERALL HEIGHT C	
in.	mm.			in.	mm.
LL Series					
.25	6,4	3793	LL 250	.84	21,2
.38	9,5	3795	LL 375	1.02	25,9
.50	12,7	3797	LL 500	1.20	30,4
.75	19,1	3799	LL 750	1.45	36,8

Standard color natural.

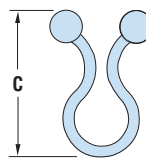

- Part Description Key (part numbers **4155** thru **4172** only): PMLL XX-YY, where XX = Maximum Bundle Diameter (inches) and YY = Height Above Panel (inches).

Standoff Loops - Arrowhead Mount

MAXIMUM BUNDLE DIAMETER		PART NO. Natural	DESCRIPTION	SPACER HEIGHT A		OVERALL LENGTH ABOVE PANEL C		MOUNTING HOLE	
in.	mm.			in.	mm.	in.	mm.	in.	mm.

PMLL Series For Panels from .03" (0,8 mm) - .08" (2,0 mm) thick

.28	7,0	14155M	PMLL 28-16-1	.16	4,0	.91	23,1	.156	4,0	NEW!
		14155	PMLL 28-19-1	.19	4,8	.94	23,9			NEW!
		14156	PMLL 28-50-1	.50	12,7	1.25	31,8			NEW!
		14157	PMLL 28-75-1	.75	19,1	1.50	38,2			NEW!
		14158	PMLL 28-100-1	1.00	25,4	1.75	44,5			NEW!
.28	7,0	4155M	PMLL 28-16	.16	4,0	.91	23,1	.236	6,0	NEW!
		4155	PMLL 28-19	.19	4,8	.94	23,9			NEW!
		4156	PMLL 28-50	.50	12,7	1.25	31,8			NEW!
		4157	PMLL 28-75	.75	19,1	1.50	38,2			NEW!
		4158	PMLL 28-100	1.00	25,4	1.75	44,5			NEW!
.39	10,0	4160	PMLL 39-19	.19	4,8	1.10	27,9	.236	6,0	NEW!
		4161	PMLL 39-50	.50	12,7	1.41	35,8			NEW!
		4162	PMLL 39-75	.75	19,1	1.66	42,2			NEW!
		4163	PMLL 39-100	1.00	25,4	1.91	48,5			NEW!
.50	12,5	4165	PMLL 50-19	.19	4,8	1.28	32,5	.236	6,0	NEW!
		4166	PMLL 50-50	.50	12,7	1.59	40,4			NEW!
		4167	PMLL 50-75	.75	19,1	1.84	46,8			NEW!
		4168	PMLL 50-100	1.00	25,4	2.09	53,1			NEW!
.59	15,0	4170M	PMLL 59-16	.16	4,0	1.44	36,5	.250	6,4	NEW!
		4170	PMLL 59-19	.19	4,8	1.47	37,2			NEW!
		4171	PMLL 59-50	.50	12,7	1.78	45,2			NEW!
		4172	PMLL 59-75	.75	19,1	2.03	51,6			NEW!
		4173	PMLL 59-100	1.00	25,4	2.28	57,9			NEW!

For Panels up to .09" (2,4 mm) thick

.25	6,4	3778	PMLL 250	.14	3,6	.93	23,6	.185	4,7
.38	9,5	3779	PMLL 375	.14	3,6	1.11	28,2		
.50	12,7	3780	PMLL 500	.14	3,6	1.26	32,0		
.75	19,1	3782	PMLL 750	.14	3,6	1.55	39,4		

For Panels up to .06" (1,5 mm) thick

1.00	25,4	3796	PMLL 1000	.14	3,6	2.22	56,4	.250	6,4
------	------	-------------	-----------	-----	-----	------	------	------	-----

Standard color natural.

Material	Nylon 6/6
Flammability Rating	94V-2
Temperature Range	32°F (0°C) to 185°F (85°C)

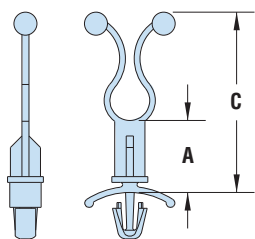

Quick Specs

HEYClip™ Lockit™ Loops and Clips Standoff Loops - Blind Mount

MAXIMUM BUNDLE DIAMETER		PART NO. Natural	DESCRIPTION	SPACER HEIGHT A		OVERALL LENGTH ABOVE PANEL C		MOUNTING HOLE DIAMETER	
in.	mm.			in.	mm.	in.	mm.	in.	mm.
BMLL Series For .25" (6,4 mm) Minimum Thickness Panels									
.28	7,0	4052M	BMLL 28-16	.16	4,0	.91	23,1	.312	7,9
		4052	BMLL 28-19	.19	4,8	.94	23,9		
		4053	BMLL 28-50	.50	12,7	1.25	31,8		
		4260	BMLL 28-75	.75	19,1	1.50	38,2		
.39	10,0	4056	BMLL 39-19	.19	4,8	1.10	27,9		
		4057	BMLL 39-50	.50	12,7	1.41	35,8		
		4261	BMLL 39-75	.75	19,1	1.66	42,2		
.50	12,5	4175	BMLL 50-19	.19	4,8	1.28	32,5		
		4176	BMLL 50-50	.50	12,7	1.59	40,4		
		4177	BMLL 50-75	.75	19,1	1.84	46,8		
.59	15,0	4180M	BMLL 59-16	.16	4,0	1.44	36,5		
		4180	BMLL 59-19	.19	4,8	1.47	37,3		
		4181	BMLL 59-50	.50	12,7	1.78	45,2		
		4182	BMLL 59-75	.75	19,1	2.03	51,6		

Standard color natural.

Standoff Lockit™ Clips - Arrowhead Mount

MAXIMUM BUNDLE DIAMETER		PART NO. Natural	DESCRIPTION	SPACER HEIGHT A		OVERALL LENGTH ABOVE PANEL C		MOUNTING HOLE DIAMETER		STYLE
in.	mm.			in.	mm.	in.	mm.	in.	mm.	
PMLC Series For Panels up to .06" (1,6 mm) thick										
.25	6,4	4185	PMLC 25-19	.19	4,8	.72	18,3	.187	4,8	1
		4186	PMLC 25-25	.25	6,4	.78	19,9			
		4187	PMLC 25-37	.37	9,5	.91	23,0			
		4188	PMLC 25-50	.50	12,7	1.03	26,2			
		4189	PMLC 25-63	.63	15,9	1.16	29,4			
		4190	PMLC 25-100	1.00	25,4	1.53	39,9			
For Panels from .03" (0,8 mm) - .08" (2,0 mm) thick										
.44	11,1	14185	PMLC 43-19	.19	4,8	.76	19,3	.187	4,8	1
		14186	PMLC 43-25	.25	6,4	.82	20,9			
		14187	PMLC 43-37	.37	9,5	.94	24,0			
		14188	PMLC 43-50	.50	12,7	1.07	27,2			
		14189	PMLC 43-63	.63	15,9	1.20	30,4			
		14190	PMLC 43-100	1.00	25,4	1.57	39,9			
.47	11,9	4345	PMLC 50-19	.19	4,8	.96	24,4	.187	4,8	2
		4346	PMLC 50-25	.25	6,4	1.02	26,0			
		4347	PMLC 50-37	.37	9,5	1.15	29,1			
		4348	PMLC 50-50	.50	12,7	1.27	32,3			
.73	18,5	4191	PMLC 73-19	.19	4,8	1.22	30,9	.187	4,8	2
		4192	PMLC 73-25	.25	6,4	1.28	32,5			
		4193	PMLC 73-37	.37	9,5	1.40	35,6			
		4194	PMLC 73-50	.50	12,7	1.53	38,8			
For Panels from .08" (2,0 mm) - .16" (4,0 mm) thick										
.47	11,9	4366	PMLC 50-19-1	.19	4,8	.96	24,4	.187	4,8	2
		4367	PMLC 50-25-1	.25	6,4	1.02	26,0			
		4368	PMLC 50-37-1	.37	9,5	1.15	29,1			
		4369	PMLC 50-50-1	.50	12,7	1.27	32,3			
.73	18,5	4195	PMLC 73-19-1	.19	4,8	1.22	30,9	.187	4,8	2
		4196	PMLC 73-25-1	.25	6,4	1.28	32,5			
		4197	PMLC 73-37-1	.37	9,5	1.40	35,6			
		4198	PMLC 73-50-1	.50	12,7	1.53	38,8			

Standard color natural.



- Part Description Key: BMLL XX-YY, where XX = Maximum Bundle Diameter (inches) and YY = Height Above Panel (inches).
- For Quick Specs see page 7-48.

NEW!

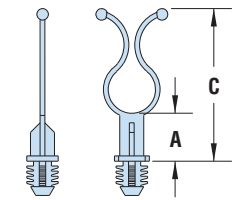

NEW!



- Locking ends click into place.
- Part Description Key: PMLC XX-YY, where XX = Maximum Bundle Diameter (inches) and YY = Height Above Panel (inches).
- For Quick Specs see page 7-48.

NEW!

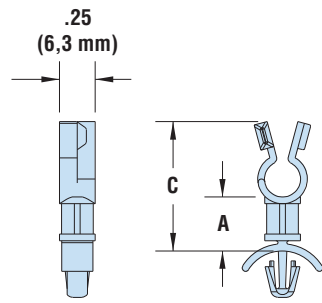

Style 1

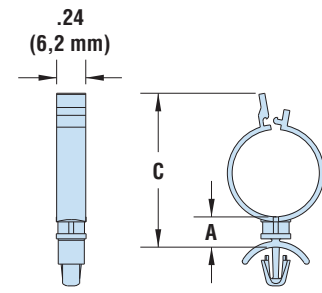

Style 2

“Stay Connected” with



HEYware

a PennEngineering® Company



- Push mount design allows for fast installation.
- Releasable and reusable wire clip.
- Bayonet design allows from .02" (0,5 mm) panel thickness to .15" (3,8 mm).
- Bayonet snap locks into a .250" (6,3 mm) hole and will hold a 25 pound continuous load or a 50 pound impact load.
- Multiple sizes available for bundles from .19" (4,7 mm) to 1.00" (25,4 mm).



HEYClip™ Locking Releasable Wire Clips - Arrowhead Mount

MAXIMUM BUNDLE DIAMETER	PART NO.		DESCRIPTION	FOOTPRINT		OVERALL HEIGHT		CLAMP WIDTH		MOUNTING HOLE DIA.	
	Gray	Black		A x B	C	D	in.	mm.	in.	mm.	

PMWC Series For Panels .02" (0,5 mm) to .08" (2,0 mm) thick												
.19	4,7	3845	3870	PMWC 187-20	.54 x 1.01	13,7 x 25,7	.39	9,9	.38	9,7	.250	6,4
.25	6,4	3846	3871	PMWC 250-20	.58 x 1.01	14,7 x 25,7	.45	11,4	.41	10,4		
.38	9,5	3847	3872	PMWC 375-20	.65 x 1.01	16,5 x 25,7	.53	13,5	.50	12,7		
.50	12,7	3848	3906	PMWC 500-20	.75 x 1.20	19,1 x 30,5	.73	18,5	.59	15,0		
.75	19,1	3849	3908	PMWC 750-20	.88 x 1.38	22,4 x 35,1	.99	25,1	.67	17,0		
1.00	25,4	3853	3909	PMWC 1000-20	1.37 x 1.88	34,8 x 47,8	1.35	34,3	.99	25,1		

For Panels .09" (2,3 mm) to .15" (3,8 mm) thick												
.19	4,7	3880	3910	PMWC 187-90	.54 x 1.01	13,7 x 25,7	.39	9,9	.38	9,7	.250	6,4
.25	6,4	3881	3912	PMWC 250-90	.58 x 1.01	14,7 x 25,7	.45	11,4	.41	10,4		
.38	9,5	3882	3913	PMWC 375-90	.65 x 1.01	16,5 x 25,7	.53	13,5	.50	12,7		
.50	12,7	3883	3914	PMWC 500-90	.75 x 1.20	19,1 x 30,5	.73	18,5	.59	15,0		
.75	19,1	3884	3915	PMWC 750-90	.88 x 1.38	22,4 x 35,1	.99	25,1	.67	17,0		
1.00	25,4	3885	3916	PMWC 1000-90	1.37 x 1.88	34,8 x 47,8	1.35	34,3	.99	25,1		

Standard color gray or black.

Arrowhead Mount Instructions



Simply insert base of clip into .250" diameter hole.

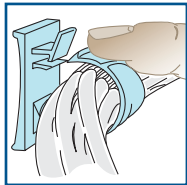

HEYClip opens easily for access to bundle.



Unique lock/release feature operates easily and locks securely. When closed, HEYClip will not open until tab is released.

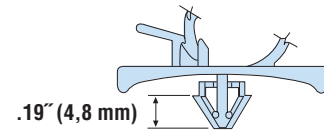
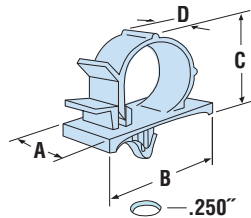

Release tab provides easy opening without forcing.

Barbed locking element ensures reliable retention.

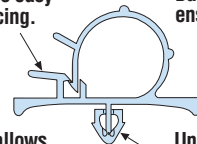

Quick lock/release allows fast lock-up and easy access to wire bundle.

Unique design of push mount permits fast installation and provides high pull-out resistance.

Quick Specs

Material	Nylon 6/6
Flammability Rating	94V-2
Temperature Range	32°F (0°C) to 185°F (85°C) - Gray 32°F (0°C) to 221°F (105°C) - Black

“Stay Connected” with



HEYware

a PennEngineering® Company

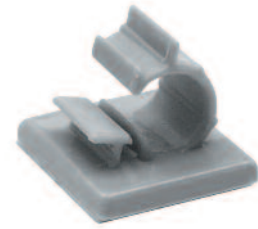

HEYClip™ Locking Releasable Wire Clips - Adhesive-Back Mount

MAXIMUM BUNDLE DIAMETER			RATED STATIC LOAD		PART NO. Adhesive			DESCRIPTION	FOOTPRINT		OVERALL HEIGHT		CLAMP WIDTH	
A		B	lb.	kg.	Standard	Super			A x B		C		D	
in.	mm.				Gray	Black	Black	in.	mm.	in.	mm.	in.	mm.	
WCA Series														
.19	4,7	1/2	3857	3917	-	-	WCA 187-500	.74 x .62	18,8 x 15,7	.34	8,6	.39	9,9	
.25	6,4	3/4	3858	3918	3918A	-	WCA 250-750	1.00 x .87	25,4 x 22,1	.42	10,7	.63	16,0	
.38	9,5	1	3859	3919	3919A	-	WCA 375-1000	1.00 x 1.00	25,4 x 25,4	.50	12,7			
.50	12,7	1-1/4	3860	3920	3920A	-	WCA 500-1250	1.00 x 1.21	25,4 x 30,7	.68	17,3			
.75	19,1	1-3/4	3861	3921	-	-	WCA 750-1750	1.15 x 1.45	29,2 x 36,8	.99	25,1	.64	16,3	
1.00	25,4	4	3867	3923	-	-	WCA1000-4000	1.98 x 2.24	50,3 x 56,9	1.37	34,8	1.26	32,0	
1.50	38,1	6	3868	3930	-	-	WCA 1500-6000	2.42 x 2.95	61,5 x 74,9	1.77	45,0	1.31	33,3	

Standard color gray or black. Super duty adhesive backing available as shown.

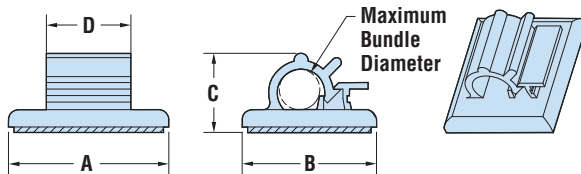

- Adhesive backing on part has a tab for easy removal.
- Releasable and reusable clips for easy wire bundle routing.
- Quick and easy installation—simply peel off backing and press into place.
- Multiple sizes for bundles from .19" (4,7 mm) to 1.50" (38,1 mm) in diameter.
- Static Loads pertain to parts fastened to a flat, clean, and dry surface.
- Three sizes in Super Adhesive Black.



HEYClip™ Locking Releasable Wire Clips - Adjustable

MAXIMUM BUNDLE DIAMETER RANGE				PART NO.	DESCRIPTION	OVERALL HEIGHT		FOOTPRINT	
A		B				D *		B x C	
Minimum	Maximum			Natural		in.	mm.	in.	mm.
in.	mm.	in.	mm.						
WCLP Series - Arrowhead Mount									
.47	11,9	.55	14,0	4335	WCLP 562	1.17	29,8	.50 x 1.24	12,7 x 31,5
.58	14,7	.75	19,1	4336	WCLP 750	1.36	34,5	.50 x 1.48	12,7 x 37,6
WCLA Series - Adhesive Mount**									
.22	5,5	.26	6,5	4323	WCLA 258	.74	18,8	.65 x .85	16,5 x 21,6
.31	7,9	.41	10,3	4324	WCLA 406	.90	22,8	.75 x 1.00	19,1 x 25,4
.47	11,9	.56	14,3	4325	WCLA 562	1.12	28,5	.75 x 1.24	19,1 x 31,5
.58	14,7	.75	19,1	4326	WCLA 750	1.32	33,6	.75 x 1.50	19,1 x 38,1
.87	22,2	1.00	25,4	4327	WCLA 1000	1.78	45,3	1.00 x 1.97	25,4 x 50,1

Standard color natural. *At maximum wire capacity. **Adhesive-Back is 1/16" (1,6 mm) thick.

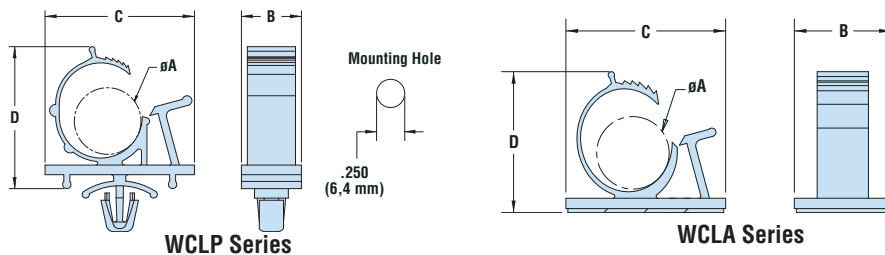

WCLP Series:

- Gather and route wires.
- Adjust to diameter needed to bundle.
- Push mount design allows for fast installation.

WCLA Series:

- Lock securely and easily. Re-open for routing changes.
- Ratcheting clip holds bundle securely in place.
- Good for high vibration applications. Once closed the clip will not open until tab is released.

Material	Nylon 6/6
Flammability Rating	94V-2
Temperature Range	-20°F (-29°C) to 150°F (66°C) (Adhesive-Back) -40°F (-40°C) to 185°F (85°C) (Adjustable)

Quick Specs



- Designed to mount easily on panel with push rivet (see table) or a #6 screw.
- Allows mounting to a wide range of panel thicknesses.
- See Quick Specs on page 7-55.

HEYClip™ Cable Holders - Snap Rivet Mount

WIRE CAPACITY		PART NO.	DESCRIPTION	OVERALL HEIGHT C		FOOTPRINT A x B		MOUNTING HOLE DIAMETER			
in.	mm.			in.	mm.	in.	mm.	in.	mm.		
Top Entry - Regular Gate											
.44	x .17	11,1	x 4,3	12025	CHSR R-11	.45	11,4	.49 x .61	12,4 x 15,5	.144	3,7
	x .36		x 9,1	12026	CHSR R-16	.64	16,3				
	x .73		x 18,5	12027	CHSR R-25	1.00	18,5				
	x 1.04		x 26,4	12028	CHSR R-33	1.31	26,4				
Top Entry - Latch Gate											
.44	x .14	11,1	x 3,6	12029	CHSR L-11	.45	11,4	.49 x .61	12,4 x 15,5	.144	3,7
	x .34		x 8,6	12030	CHSR L-16	.64	16,3				
	x .72		x 18,3	12031	CHSR L-25	1.00	25,4				
	x 1.00		x 25,4	12032	CHSR L-33	1.31	33,3				

NEW PRODUCTS!

Standard color natural.

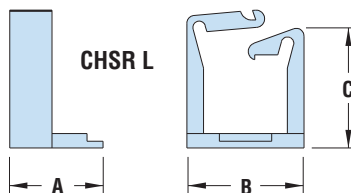
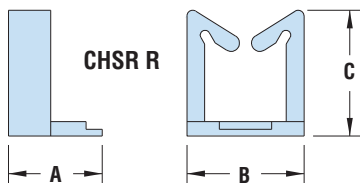

Rivet Table for CHSR			
PART NO.	DESCRIPTION	PANEL THICKNESS	
		in.	mm.
9044	PR 142-047 BLACK	.01-.05	0,3-1,2
9046	PR 142-083 BLACK	.05-.08	1,2-2,1
9048	PR 142-106 BLACK	.07-.11	1,8-2,7
9050	PR 142-118 BLACK	.08-.12	2,1-3,0
9052	PR 142-146 BLACK	.11-.14	2,8-3,7
9054	PR 142-177 BLACK	.14-.18	3,6-4,6
9056	PR 142-217 BLACK	.18-.22	4,6-5,6



HEYClip™ Cable Holders - Two Prong Mount

For panels up to .063" (1,6 mm) thick

WIRE CAPACITY		PART NO.	DESCRIPTION	OVERALL HEIGHT C		FOOTPRINT A x B		MOUNTING HOLE DIAMETER			
in.	mm.			in.	mm.	in.	mm.	in.	mm.		
Top Entry - Regular Gate											
.44	x .19	11,1	x 4,8	4337	CH R-13-P	.51	13,0	.22 x .61	5,6 x 15,5	.187	4,8
	x .38		x 9,7	4338	CH R-18-P	.71	18,0				
	x .74		x 18,8	4339	CH R-27-P	1.06	26,9				
	x 1.05		x 26,7	4340	CH R-35-P	1.37	34,8				
Top Entry - Latch Gate											
.44	x .14	11,1	x 3,6	4341	CH L-13-P	.51	13,0	.22 x .61	5,6 x 15,5	.187	4,8
	x .33		x 8,4	4342	CH L-18-P	.71	18,0				
	x .69		x 17,5	4343	CH L-27-P	1.06	27,0				
	x 1.00		x 25,4	4344	CH L-35-P	1.37	34,8				

Standard color natural. Flame retardant UL 94V-0 material available, consult Heyco.

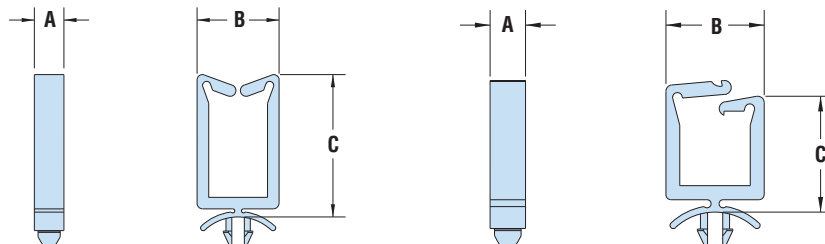

Regular Gate

Latch Gate

- Gather and direct single or bundles of cable at low cost.
- **Two orientations:**
 1. Vertical for **Top Entry** and narrow width.
 2. Horizontal for **Side Entry** and low height where clearance is a problem.
- **Two gate types:**
 1. Regular gate secures cables with tension alone.
 2. Latch gate locks cables in place.

Both types install with fingertip pressure into a 3/16" (4,8 mm) diameter mounting hole.
- Part Description Key: CH X-Y-Z, where R = Regular Gate, L = Latch Gate, Y = Overall Height (mm) and P indicates the Split Prong mounting design.
- See Quick Specs on page 7-55.



HEYClip™ Shorty Cable Holders

Arrowhead Mount – Overall Height ≤ .51" (13,0 mm)

WIRE CAPACITY		PART NO.		DESCRIPTION	OVERALL HEIGHT C		FOOTPRINT A x B		MOUNTING HOLE DIA.		STYLE
in.	mm.	Natural 94V-2	94V-0		in.	mm.	in.	mm.	in.	mm.	
MH1,7 Series For Panels up to .063" (1,6 mm) thick											
.19 x .04	4,8 x 0,9	4245	-	CHRS 41-1 †	.16	4,1	.08 x .28	2,0 x 7,0	.067	1,7	3
MH1,8 Series For Panels up to .063" (1,6 mm) thick											
.17 x .12 x .33	4,3 x 3,0 x 8,5	4222	4222F	CHRS 58-1	.23	5,8	.07 x .27	1,9 x 6,9	.071	1,8	1
		4223	4223F	CHRS 112-1	.44	11,2					
For Panels up to .090" (2,3 mm) thick											
.17 x .12 x .33	4,3 x 3,0 x 8,5	4224	4224F	CHRS 58-2	.23	5,8	.07 x .27	1,9 x 6,9	.071	1,8	1
		4225	4225F	CHRS 112-2	.44	11,2					
MH3,0 Series For Panels up to .063" (1,6 mm) thick											
.16 x .25	4,1 x 6,4	3660	-	CHRS 1	.29	7,4	.17 x .36	4,3 x 9,1	.118	3,0	2
.26 x .12	6,6 x 3,0	4226	4226F	CHRS 73-1	.29	7,3	.16 x .36	4,0 x 9,1*			
.32 x .16	8,1 x 3,9	4227	4227F	CHRS 91-1	.36	9,1	.16 x .43	4,0 x 10,8			
.36 x .24 x .30	9,1 x 6,0 x 7,7	4228	4228F	CHRS 112-1	.44	11,2	.16 x .47	4,0 x 12,0			
		4229	4229F	CHRS 130-1	.51	13,0					
For Panels up to .100" (2,6 mm) thick											
.26 x .12	6,6 x 3,0	4230	4230F	CHRS 73-2	.29	7,3	.16 x .36	4,0 x 9,1*	.118	3,0	2
.32 x .16	8,1 x 3,9	4231	4231F	CHRS 91-2	.36	9,1	.16 x .43	4,0 x 10,8			
.36 x .24 x .30	9,1 x 6,0 x 7,7	4232	4232F	CHRS 112-2	.44	11,2	.16 x .47	4,0 x 12,0			
		4233	4233F	CHRS 130-2	.51	13,0					
MH3,5 Series For Panels up to .063" (1,6 mm) thick											
.16 x .25 x .35	4,1 x 6,4 x 8,9	3661	-	CHRS 2	.29	7,4	.17 x .36	4,3 x 9,1	.138	3,5	2
		3662	-	CHRS 3	.45	11,4	.17 x .48	4,3 x 12,2			
.26 x .12	6,6 x 3,0	4234	4234F	CHRS 73-1-2	.29	7,3	.16 x .36	4,0 x 9,1*			
.32 x .16	8,1 x 3,9	4235	4235F	CHRS 91-1-2	.36	9,1	.16 x .43	4,0 x 10,8			
.36 x .24 x .30	9,1 x 6,0 x 7,7	4236	4236F	CHRS 112-1-2	.44	11,2	.16 x .47	4,0 x 12,0			
		4237	4237F	CHRS 130-1-2	.51	13,0					
For Panels up to .090" (2,3 mm) thick											
.26 x .12	6,6 x 3,0	4238	4238F	CHRS 73-2-2	.29	7,3	.16 x .36	4,0 x 9,1*	.138	3,5	2
.32 x .16	8,1 x 3,9	4239	4239F	CHRS 91-2-2	.36	9,1	.16 x .43	4,0 x 10,8			
.36 x .24 x .30	9,1 x 6,0 x 7,7	4262	4262F	CHRS 112-2-2	.44	11,2	.16 x .47	4,0 x 12,0			
		4263	4263F	CHRS 130-2-2	.51	13,0					

Standard color natural 94V-2 and natural 94V-0.

† Two Prong mounting style.

*Features raised “bumps” on sides of part.

- Part Description Key: CHRS-X-Y-Z, where X = Overall Height (mm), Y = Mounting Panel Thickness (mm) and Z (if present) indicates a different Mounting Hole Dia.
- For Shorty Side Entry Cable Holders, see page 7-62.

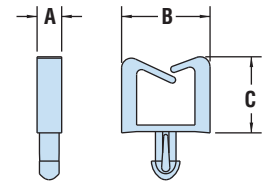
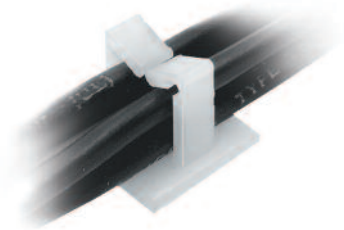

Style 1

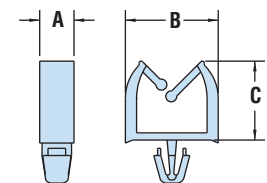

Style 2

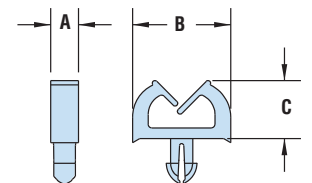

Style 3

Material	Nylon 6/6
Flammability Rating	94V-2
Temperature Range	32°F (0°C) to 185°F (85°C)

Quick Specs

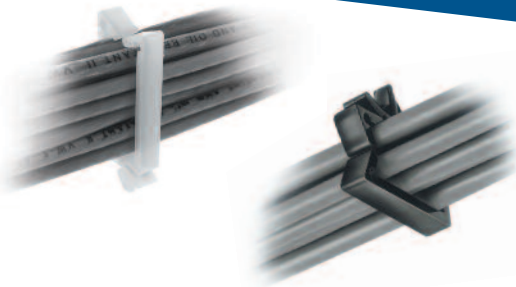

HEYClip™ Cable Holders - Arrowhead Mount

- Gather and direct single or bundles of cable at low cost.
- **Two orientations:**
 1. Vertical for **Top Entry** and narrow width.
 2. Horizontal for **Side Entry** and low height where clearance is a problem.
- **Two gate types:**
 1. Regular gate secures cables with tension alone.
 2. Latch gate locks cables in place.
- Both types install with fingertip pressure into a 3/16" (4,8 mm) diameter mounting hole.

Top Entry: Part Description Key: CH X-Y-Z, where R = Regular Gate, L = Latch Gate, Y = Overall Height (mm), and Z, if present, distinguishes Panel Thickness.

Side Entry: Part Description Key: CH X-Y-Z, where R = Regular Gate, L = Latch Gate Y = Approximate Overall Length (mm), and Z is always 90 indicating a Side Entry part.

WIRE CAPACITY		PART NO.		DESCRIPTION	OVERALL HEIGHT C		FOOTPRINT A x B		MOUNTING HOLE DIA.			
in.	mm.	Natural	Black		in.	mm.	in.	mm.	in.	mm.		
Top Entry-Regular Gate For Panels up to .047" (1,2 mm) thick												
.80	x .50	20,3	x 12,7	3596	-	CH R-20 *	.77	19,6	.22 x .93	5,5 x 23,6	.187	4,8
	x .85		x 21,6	3597	-	CH R-28 *	1.11	28,4				
For panels up to .078" (1,9 mm) thick												
.44	x .19	11,1	x 4,8	3600	3600B	CH R-12	.48	12,2	.22 x .61	5,6 x 15,5	.187	4,8
	x .38		x 9,7	3605	3605B	CH R-18	.72	18,2				
	x .74		x 18,8	3610	3610B	CH R-27	1.06	27,0				
	x 1.05		x 26,7	3615	3615B	CH R-35	1.38	35,0				
For Panels up to .125" (3,2 mm) thick												
.44	x .19	11,1	x 4,8	3601	3601B	CH R-13-3	.51	13,0	.22 x .61	5,6 x 15,5	.187	4,8
	x .38		x 9,7	3606	3606B	CH R-18-3	.71	18,0				
	x .74		x 18,8	3611	3611B	CH R-27-3	1.06	26,9				
	x 1.05		x 26,7	3616	3616B	CH R-35-3	1.37	34,8				
Top Entry-Latch Gate For Panels up to .078" (1,9 mm) thick												
.44	x .14	11,1	x 3,6	3620	3620B	CH L-12	.48	12,2	.22 x .61	5,6 x 15,5	.187	4,8
	x .33		x 8,4	3625	3625B	CH L-18	.72	18,3				
	x .69		x 17,5	3630	3630B	CH L-27	1.07	27,2				
	x 1.00		x 25,4	3635	3635B	CH L-35	1.39	35,3				
For Panels up to .125" (3,2 mm) thick												
.44	x .14	11,1	x 3,6	3602	3602B	CH L-13-3	.51	13,0	.22 x .61	5,6 x 15,5	.187	4,8
	x .33		x 8,4	3607	3607B	CH L-18-3	.71	18,0				
	x .69		x 17,5	3612	3612B	CH L-27-3	1.06	27,0				
	x 1.00		x 25,4	3617	3617B	CH L-35-3	1.38	35,0				
Side Entry-Regular Gate For Panels up to .063" (1,6 mm) thick												
NEW!	.43 x .38	10,9	9,7	3609	-	CH R-17-90	.63	16,0	.22 x .54	5,6 x 13,6	.187	4,8
	.19 x .42		4,8 x 10,7	3618	-	CH R-11-90	.42	10,7				
For Panels up to .090" (2,3mm) thick												
.44	x .75	11,1	x 19,1	3652**	3652B	CH R-27-90	.62	15,9	.22 x 1.00	5,6 x 25,4	.187	4,8
	x 1.06		x 26,9	3667**	3667B	CH R-35-90	.62	15,9				
Side Entry-Latch Gate For Panels up to .090" (2,3 mm) thick												
.44	x .72	11,1	x 18,3	3697**	3697B	CH L-27-90	.66	16,7	.22 x 1.00	5,6 x 25,4	.187	4,8
	x 1.03		x 26,2	3712**	3712B	CH L-35-90	.66	16,7				

Standard colors natural and black, except as noted. Flame retardant UL 94V-0 material available, consult Heyco.

* Part Nos. **3596** and **3597** are of relatively wide construction, relative to the parts that follow.

** White

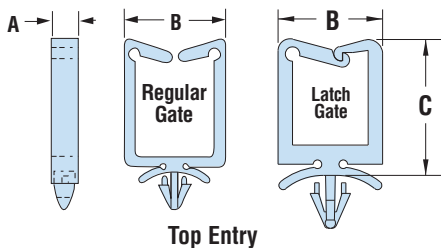

Top Entry

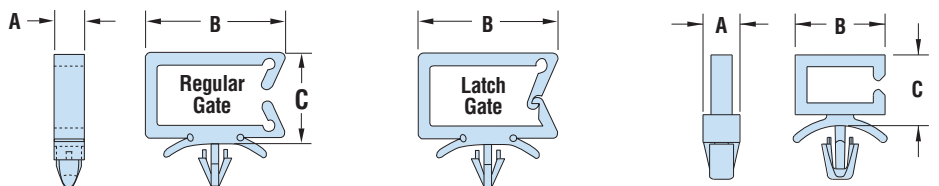

Side Entry

Part No. 3618

Material	Nylon 6/6
Certifications	Recognized under UL File E54523 (Top Entry parts only)
Flammability Rating	94V-2
Temperature Range	32°F (0°C) to 185°F (85°C)

“Stay Connected” with



HEYware

a PennEngineering® Company



HEYClip™ Cable Holders - Blind Head Mount

For .250" (6,4 mm) *Minimum* Thickness Panels

WIRE CAPACITY		PART NO.	DESCRIPTION	OVERALL HEIGHT C		FOOTPRINT A x B		MOUNTING HOLE DIA.		
in.	mm.			in.	mm.	in.	mm.	in.	mm.	
Top Entry - Regular Gate										
.44	x .19	11,1	4202	CH RB-13	.51	13,0	.22 x .61	5,6 x 15,5	.312	7,9
	x .38		4203	CH RB-18	.71	18,0				
	x .74		4204	CH RB-27	1.06	26,9				
	x 1.05		4205	CH RB-35	1.40	35,6				
Top Entry - Latch Gate										
.44	x .14	11,1	4206	CH LB-13	.51	13,0	.22 x .61	5,6 x 15,5	.312	7,9
	x .33		4207	CH LB-18	.71	18,0				
	x .69		4208	CH LB-27	1.06	27,0				
	x 1.00		4209	CH LB-35	1.38	35,0				
Side Entry - Regular Gate*										
.11	x .33	2,8	4220	CH RB-13-90	.20	5,1	.37 x .50	9,5 x 12,7	.157	4,0
	x .49		4221	CH RB-17-90	.20	5,1	.37 x .67	9,5 x 17,0		

Standard color natural. Flame retardant UL 94V-0 material available, consult Heyco. *For Panel thickness up to .161" (4,1 mm)

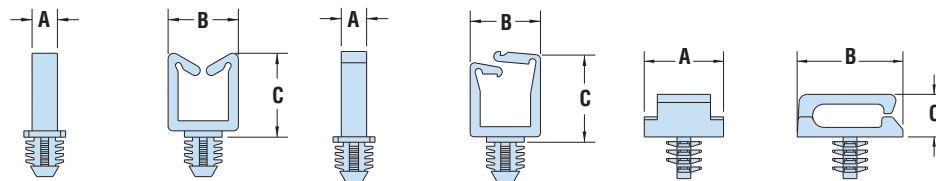

Top Entry Regular Gate

Top Entry Latch Gate

Side Entry Regular Gate

- Gather and route cables.
- Part Description Key: CH RB-X, where X = Overall Height (mm).



- Gather and direct single or bundles of cable.
- Apply to a clean, dry surface.
- Adhesive backing on part has tab for easy removal.
- Part Description Key: CH RA-X, where X = Overall Height (mm).
- Feature convenient peel away tab (or something like that - should agree with other AB parts).
- Part Description Key: CH RA-X, where X = Overall Height (mm).

HEYClip™ Cable Holders - Adhesive Back Mount

WIRE CAPACITY		PART NO.	DESCRIPTION	OVERALL HEIGHT C		FOOTPRINT A x B		STYLE	
in.	mm.			in.	mm.	in.	mm.		
CH RA Series									
.17	x .12	4,4 x 3,0	4271	CH RA-72	.31	7,9	.37 x .37	9,5 x 9,5	4
.18	x .04		4212	CH RA-65	.26	6,5	.37 x .37	9,4 x 9,4	
	x .11		4213	CH RA-83	.33	8,3			
.25	x .13	7,9 x 4,1	4214	CH RA-102	.40	10,2	.50 x .50	12,7 x 12,7	1
.31	x .16		4215	CH RA-119	.47	11,9			
.35	x .24	8,9	4216	CH RA-141	.56	14,1			
	x .31		4217	CH RA-157	.62	15,7			
.45	x .19	11,4 x 9,5	3603	CH RA-122	.47	11,9	.76 x .74	19,3 x 18,8	2
	x .38		3608	CH RA-172	.68	17,2			
	x .75		3613	CH RA-267	1.05	26,7			
.29	x .25	7,4 x 6,4	3614	CH RA-121	.48	12,1	.50 x 1.00	12,7 x 25,4	3

Standard color natural. Flame retardant UL 94V-0 material available, consult Heyco.

Material	Nylon 6/6
Flammability Rating	94V-2
Temperature Range	32°F (0°C) to 185°F (85°C)

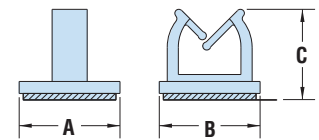

Style 1

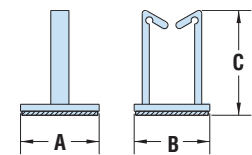

Style 2

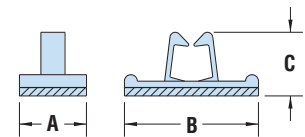

Style 3

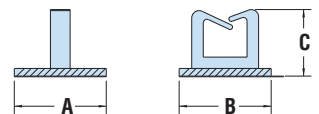

Style 4



- Self-adjusting Arrowhead Mount protrudes approximately .22" (5,6 mm). (CHSO only)
- Part Description Key: CH SO-X, where X = Overall Height (mm).
- Self-adjusting Arrowhead Mount protrudes approximately .20" (5,1 mm).

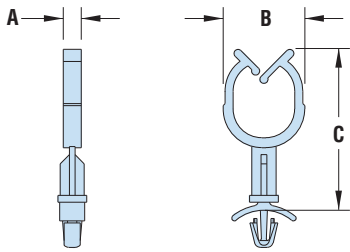

CH SO Series

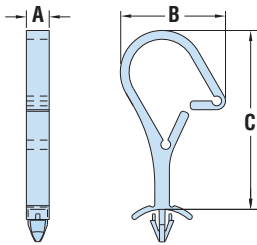

CH RJ Series

HEYClip™ Standoff Cable Holders - Arrowhead Mount

WIRE CAPACITY		PART NO.		DESCRIPTION	HEIGHT ABOVE PANEL C		FOOTPRINT A x B		MOUNTING HOLE DIA.	
in.	mm.	Natural			in.	mm.	in.	mm.	in.	mm.
CH SO Series For Panels up to .063" (1,6 mm) thick										
.54 x .54	13,6 x 13,6		3349	CH SO-6	1.00	25,5	16 x .71	4,0 x 18,0	.187	4,8
			3350	CH SO-8	1.08	27,5				
			3351	CH SO-10	1.16	29,5				
			3359	CH SO-12	1.24	31,5				
			3360	CH SO-14	1.32	33,5				
			3361	CH SO-16	1.40	35,5				
			3369	CH SO-18	1.48	37,5				
			3370	CH SO-20	1.56	39,5				
			3371	CH SO-22	1.63	41,5				
			3385	CH SO-24	1.71	43,5				
			3386	CH SO-26	1.79	45,5				
			3387	CH SO-28	1.87	47,5				
CH RJ Series For Panels .09" (2,3 mm) thick										
.62	15,7		3598	CH RJ-625	1.70	42,9	.22 x 1.00	5,6 x 25,4	.187	4,8

Standard color natural. Flame retardant UL 94V-0 material available, consult Heyco.

HEYClip™ Round Cable Holders

BUNDLE DIAMETER		PART NO.		DESCRIPTION	OVERALL HEIGHT C		FOOTPRINT A x B		MOUNTING HOLE		STYLE
in.	mm.	Natural	Black		in.	mm.	in.	mm.	in.	mm.	
Arrowhead Mount - For Panels from .030" (0,8 mm) to .060" (1,5 mm) thick											
.45	11,4	3663	3663B	CHCS 4	.57	14,5	.18 x .57	4,5 x 14,5	.12	3,1	1
.62	15,9	3666	3666B	CHCS 10	.97	24,6	.30 x 1.03	7,5 x 26,2	.25	6,4	2
Arrowhead Mount - For Panels from .058" (1,5 mm) to .064" (2,5 mm) thick											
1.00	25,4	3668	3668B	CHCS 16	1.34	34,1	.38 x 1.25	9,5 x 31,7	.25	6,4	3
Slotted with Adhesive Back Mount											
.62	15,9	3931	-	CHCS 10A	.95	24,1	1.00 x 1.00	25,4 x 25,4	.25	6,4	4
Slotted for Screw Mount											
.62	15,9	3932	-	CHCS 10B	.92	23,3	1.00 x 1.00	25,4 x 25,4	.25	6,4	4

Standard color natural. Flame retardant UL 94V-0 material available, consult Heyco.

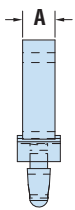

Style 1

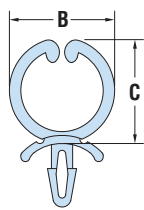

Style 2

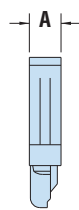

Style 3

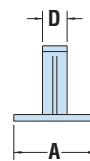
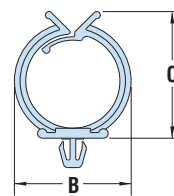
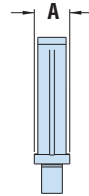
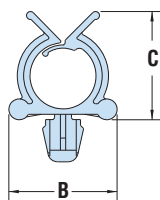

Style 4

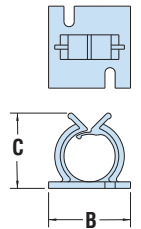

Quick Specs

Material	Nylon 6/6
Flammability Rating	94V-2
Temperature Range	32°F (0°C) to 185°F (85°C)

“Stay Connected” with



HEYware

a PennEngineering® Company



HEYClip™ Lockit™ Cable Holders - Arrowhead Mount

WIRE CAPACITY		PART NO.	DESCRIPTION	OVERALL HEIGHT C		FOOTPRINT A x B		MOUNTING HOLE DIA.		STYLE
in.	mm.			in.	mm.	in.	mm.	in.	mm.	
Top Entry For Panels up to .063" (1,6 mm) thick										
.11 x .19	2,9 x 4,8	3310	CH LK-49	.19	4,9	.08 x .34	2,0 x 8,7	.063	1,6	1
.15 x .52	3,7 x 13,1	3311	CH LK-90	.35	9,0	.20 x .77	5,0 x 19,6	.138	3,5	2
.15 x .53	3,7 x 13,5	3345	CH LK-95	.37	9,5	.20 x .77	5,0 x 19,6	.187	4,8	
.19 x .42	4,8 x 10,7	3319	CH LK-106	.42	10,6	.20 x .69	5,0 x 17,4			
.35 x .42	8,8 x 10,7	3320	CH LK-146	.57	14,6					
.39 x .63	10,0 x 16,1	3321	CH LK-158	.62	15,8	.20 x .88	5,0 x 22,3			
.74 x .85	18,0 x 21,7	3391	CH LK-273	1.07	27,3	.20 x .96	5,0 x 24,3			
Top Entry For Panels up to .125" (3,2 mm) thick NEW PRODUCT!										
.55 x .64	14,1 x 16,3	3347	CH LK-196	.78	19,8	.20 x .89	5,0 x 22,6	.187	4,8	2
Side Entry Snap-in Style - see schematic drawing NEW PRODUCT!										
.28 x .46	7,2 x 11,6	12162F	CH LKS-144	.57	14,4	.55 x .57	14,0 x 14,6	Snap-in		3

Standard color natural. Flame retardant UL 94V-0 material available, consult Heyco.

*V-0 natural material available, consult Heyco. Note: V-0 material standard for Part No. 12162F.

- Lock securely on closure.
- Self-adjusting Arrowhead Mount protrudes approximately as follows:
 - PN 3310 .06" (1,5 mm)
 - PN 3311 .12" (3,0 mm)
 - PN 3319-3347 .22" (5,6 mm)
- Part Description Key: CH LK-X, where X = Overall Height (mm).

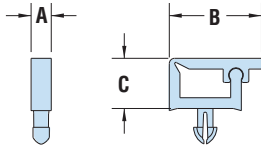

Style 1

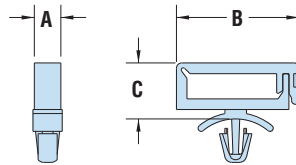

Style 2

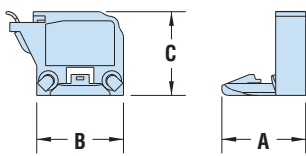

Style 3

Mounting Hole Dimensions

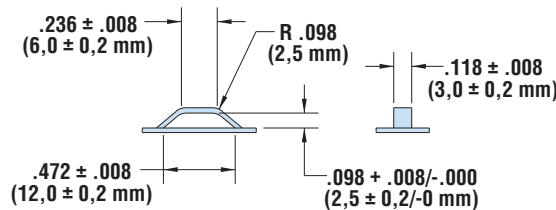

Material	Nylon 6/6
Flammability Rating	94V-0
Temperature Range	32°F (0°C) to 185°F (85°C)

Quick Specs



- Lock securely and adhere to most clean, dry surfaces.
- Part No. 3309 maximum flat wire height .50" (12,7 mm), width 1.25" (31,8 mm)
- Part No. 3395 maximum flat wire height .25" (6,4 mm), width 1.25" (31,8 mm)
- Part No. 3397 maximum flat wire height .25" (6,4 mm), width 2.50" (63,5 mm)

HEYClip™ Hinged Cable Holders

WIRE CAPACITY		PART NO. Natural	DESCRIPTION	PART DIMENSIONS									
in.	mm.			A Length		B Width		C Height		D MH Spacing			
Double Arrowhead Mount For Panels from .030" (0,8 mm) to .039" (1,0 mm) Thick													
.37 x 1.11	28,1 x 9,3	12136	CH H-37-111	1.57	40,0	.31	8,0	.52	13,3	.787	20,0	NEW!	
For Panels up to .118" (3,0 mm) Thick													
.55 x .75	19,1 x 13,9	12139	CH H-55-75	1.22	31,0	.31	8,0	.73	18,6	.630	16,0	NEW!	
Adhesive Back Mount													
.25 x 1.25	5,6 x 31,8	3395	CH HA-25-125*	1.75	44,5	.75	19,1	.50	12,7				
.50 x 1.25	11,2 x 31,8	3309	CH HA-50-125*	1.75	44,5	.75	19,1	.75	19,1				
.25 x 2.50	12,7 x 63,5	3397	CH HA-25-250	3.00	76,2	.75	19,1	.50	12,7				

Standard color Natural. *Standard color Gray.

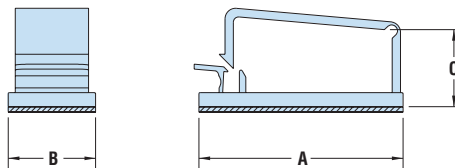

- Designed for rectangular mounting hole or edge slot mounting.
- Hinged latch design permits retrofitting into pre-wired applications.
- Route cables and protect them from sharp edges.

HEYClip™ Hinged Edge Cable Holders

Designed for Rectangular Edge Slot or Through-Hole Mounting - suitable for retrofit applications

WIRE CAPACITY		PANEL DIMENSIONS							PART NO. Natural	DESCRIPTION	PART DIMENSIONS						
in.	mm.	Thru Hole or Edge Slot				Thickness		A			B						
in.	mm.	X	Y	Z	W	in.	mm.	in.	mm.	in.	mm.						
.77 x .20	19,5 x 5,2	.858	21,8	.421	10,7	.161	4,1	.98	25,0	.031 - 0,8 - .063	1,6	3300	CH HE-25	1.19	30,2	.47	12,0
								1.02	26,0	.079	2,0						
.77 x .47	19,5 x 12,0	.870	22,0	.710	18,0	.200	5,0	.98	25,0	.020 - 0,5 - .063	1,6	3301	CH HE-22	1.22	31,0	.75	19,0

Standard color natural.

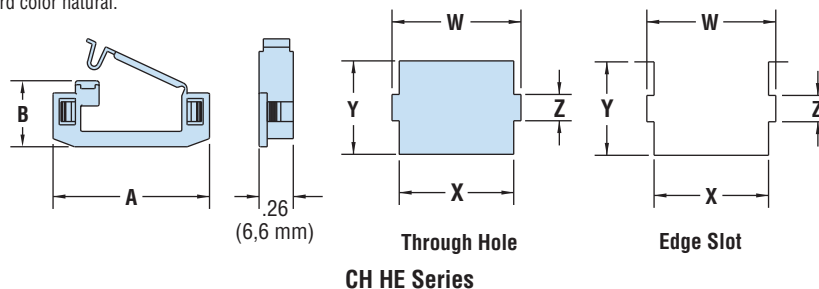

CH HE Series

Quick Specs

Material Nylon 6/6
 Flammability Rating 94V-2
 Temperature Range 32°F (0°C) to 185°F (85°C)

Heyco® Hinged Edge Strain Relief Bushings

Designed for Rectangular Edge Slot or Split Panel Mounting – suitable for retrofit applications

WILL FIT THESE CABLES				PANEL DIMENSIONS						PART NO. Black	DESCRIPTION	BODY LENGTH	
UL Type	AWG/ Conds.	Approx. Size		Edge Slot or Split Panel X		Y		Thickness				in.	mm.

ST 101A – For Round or Flat Cables

SV & SVT	18/2	.220	5,6	.512	13,0	.453	11,5	.06	1,6	1839	ST 101A	.55	14,0
	18/3	.245	6,2										
HPD	18/2	.270	6,9										
	16/2	.290	7,4										

SR 8R-200 – For Round, Flat or Multiple Cables

Round, Flat or Multiple	up to .600	up to 15,2	.875	22,2	.875	22,2	.10	2,5	1266	SR 8R-200	.80	20,3
-------------------------	------------	------------	------	------	------	------	-----	-----	------	-----------	-----	------

Standard color black. Consult Heyco for white and other colors

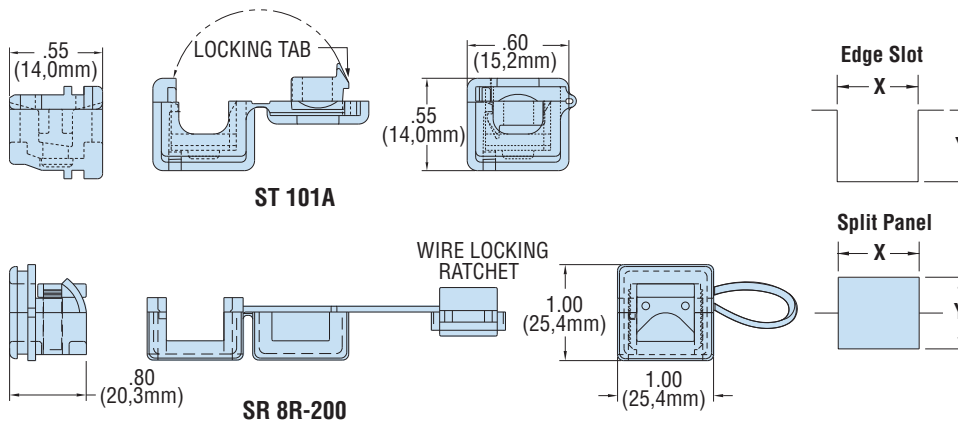

- Designed for rectangular edge slot or split panel mounting - suitable for retrofit applications.
- Independent of final mounting, Hinged Edge Strain Reliefs self-lock onto the cable and may be preassembled “off line” for final assembly at a later time or remote location.
- Rectangular design eliminates the possibility of part rotation under forces of twist.
- SR 8R-200’s unique wire locking ratchet allows for a generous wire range of .25” (6,4 mm) to .60” (15,2 mm).
- Heyco’s automated Pre-Assembly Equipment (for ST 101A only) speeds assembly onto the cable, reducing both cost and the risk of carpal tunnel syndrome. See pages 4-15 & 4-16 in the Heyco Catalog.
- For our complete line of Strain Relief Bushings, see Section 4 in the Heyco Catalog.

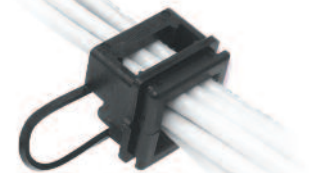

HEYClip™ Edge Cable Holders

Designed for Rectangular Edge Slot Mounting - suitable for retrofit applications

WIRE CAPACITY		PANEL DIMENSIONS Edge Slot Size						Thickness		PART NO. Natural	DESC.	PART DIMENSIONS			
in.	mm.	X		Y		W		in.	mm.			A		B	
.46 x .29	11,6 x 7,4	.551	14,0	.484	12,4	.106	2,7	.031 - .063	0,8 - 1,6	4246	CH E-14	.78	19,8	.64	16,3
.66 x .59	16,7 x 15,0	.756	19,2	.831	21,1	.098	2,5	.031 - .063	0,8 - 1,6	4247	CH E-19	1.06	26,8	.98	24,9
.66 x .58	16,8 x 14,7	.827	21,0	.827	21,0	.094	2,4	.031 - .063	0,8 - 1,6	4248	CH E-21	1.13	28,8	.98	24,9
.90 x .91	22,8 x 23,1	1.063	27,0	1.140	29,0	.118	3,0	.031 - .063	0,8 - 1,6	4249	CH E-27	1.37	34,8	1.31	33,3

Standard color natural.

Material	Nylon 6/6
Certifications	Recognized under the Component Program of Underwriters' Laboratories File E15331 (ST & SR Parts only) Canadian Certified by Canadian Standards Association File 8919 (ST & SR Parts only)
Flammability Rating	94V-2
Temperature Range	32°F (0°C) to 221°F (105°C) - (ST & SR Parts) 32°F (0°C) to 185°F (85°C) - (CH E Parts)

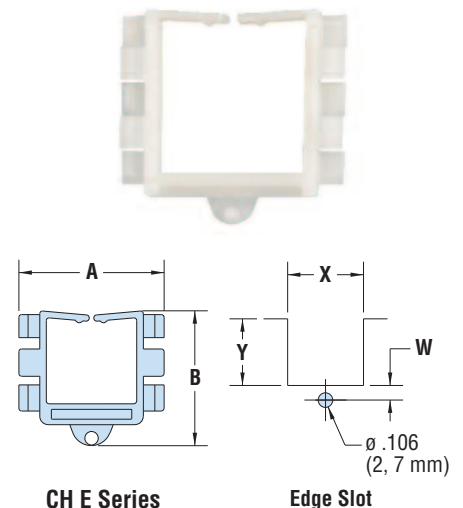

CH E Series

Edge Slot

**ALL NEW
PRODUCTS!**



HEYClip™ Shorty Side Entry Cable Holders Arrowhead Mount

- For Top Entry Shorty Cable Holders, see page 7-55.
- Ideal when space is restricted and side entry is required.

WIRE CAPACITY		PART NO. Natural	DESCRIPTION	PART DIMENSIONS						MOUNTING HOLE DIA.	
in.	mm.			A Length		B Width		C Height		in.	mm.
For Panels from .047" (1,2 mm) to .078" (2,0 mm) Thick											
.11 x .17	2,8 x 4,2	12130	CH SE-1117	.52	13,2	.20	5,0	.19	4,7	.138	3,5
.17 x .22	4,3 x 5,5	12131	CH SE-1722	.59	15,1	.20	5,0	.26	6,7		
For Panels from .062" (1,6 mm) to .094" (2,4 mm) Thick											
.10 x .17	2,6 x 4,2	12133	CH SE-1017	.50	12,7	.20	5,0	.21	5,3	.138	3,5

Standard color natural. Flame retardant UL 94V-0 material available, consult Heyco.

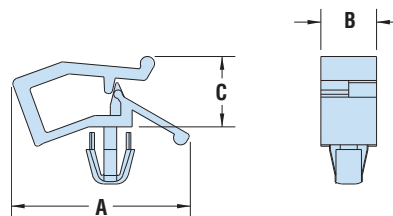

HEYClip™ Ladder Cable Holders Adhesive Back Mount

- Adjustable design secures wire bundles.
- Applies simply to clean dry surface.

**ALL NEW
PRODUCTS!**

MAXIMUM BUNDLE DIAMETER		PART NO. Natural	DESCRIPTION	PART DIMENSIONS						MOUNTING HOLE DIA.	
in.	mm.			A Length		B Width		C Ladder Width		in.	mm.
.47	12,0	12360	CH LAD-047	.79	20,0	.59	15,0	.20	5,0	.133	3,4
.77	19,5	12361	CH LAD-077								
.51	13,0	12362	CH LAD-051	.98	25,0	.71	18,0	.31	8,0	.138	3,5
.67	17,0	12363	CH LAD-067								
.73	18,5	12364	CH LAD-073								
.87	22,0	12365	CH LAD-087								
1.02	26,0	12367	CH LAD-102	1.20	30,5	.83	21,0	.47	12,0		

Standard color natural.

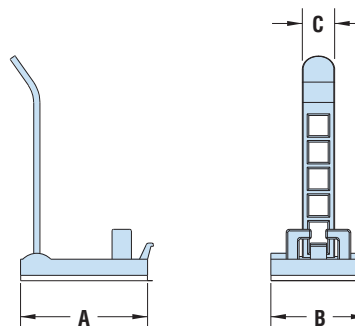

*Quick
Specs*

Material	Nylon 6/6
Flammability Rating	94V-2
Temperature Range	32°F (0°C) to 185°F (85°C)

“Stay Connected” with



HEYware

a PennEngineering® Company



HEYClip™ Split Dart Cable Holders

MAXIMUM BUNDLE DIA.		MOUNTING HOLE DIA.		PART NO. Natural	DESCRIPTION	OVERALL HEIGHT C		STYLE
in.	mm.	in.	mm.			in.	mm.	
For panels up to .047" (1,2 mm) thick								
.150	3,8	.256	6,5	12379	CH SD-38-65	.35	8,9	1
For panels up to .063" (1,6 mm) thick								
.114	2,9	.177	4,5	12387	CH SD-29-45	.25	6,4	2
.150	3,8	.256	6,5	12386	CH SD-38-65-1	.35	8,9	1
.331	8,4	.217	5,5	12380	CH SD-84-55	.43	10,9	3
		.236	6,0	12381	CH SD-84-60	.47	11,9	
For panels up to .075" (1,9 mm) thick								
.437	11,1	.236	6,0	12382	CH SD-111-60	.55	14,0	3
For panels up to .079" (2,0 mm) thick								
.197	5,0	.256	6,5	12383	CH SD-50-65	.32	8,1	3
.217	5,5	.217	5,5	12384	CH SD-55-55	.31	7,9	
.295	7,5	.217	5,5	12385	CH SD-75-55	.38	9,7	

Standard color natural.

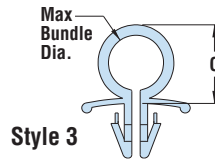
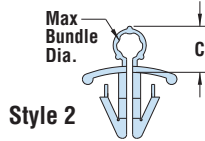
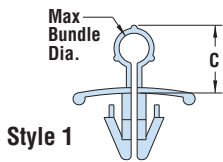

HEYClip™ Optical Fiber Network Cable Holders

WIRE CAPACITY		MOUNTING HOLE DIAMETER		DART STYLE	PART NO. Natural	DESCRIPTION	OVERALL HEIGHT C		FOOTPRINT A x B		
in.	mm.	in.	mm.				94V-2	94V-0	in.	mm.	in.
For Round Mounting Holes For panels from .031" (0,8 mm) to .079" (2,0 mm) thick											
.83 x .75	21,1 x 19,1	.187	4,8	1	12150	12150F	CH OF-282-48	1.25	31,8	.27 x 1.06	6,9 x 26,9
		.250	6,4	2	12151	12151F	CH OF-282-64				
1.13 x .99	28,7 x 25,1	.187	4,8	1	12153	12153F	CH OF-344-48	1.50	38,1	.27 x 1.35	6,9 x 34,3
		.250	6,4	2	12154	12154F	CH OF-344-64				
For Square Mounting Holes For panels from .031" (0,8 mm) to .079" (2,0 mm) thick											
.83 x .75	21,1 x 19,1	.374	9,5	4	12156	12156F	CH OF-282-95S	1.19	30,2	.27 x 1.06	6,9 x 26,9
		.307	7,8	3	12161	12161F	CH OF-344-78S				
1.13 x .99	28,7 x 25,1	.374	9,5	4	12157	12157F	CH OF-344-95S	1.44	36,6	.27 x 1.35	6,9 x 34,3
		.374	9,5	4	12158	12158F	CH OF-550-95S				
1.38 x 1.73	35,1 x 43,9	.374	9,5	4	12158	12158F	CH OF-550-95S	2.25	57,2	.27 x 1.69	6,9 x 42,9

Standard color natural.

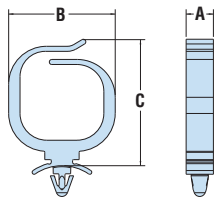

Style 1

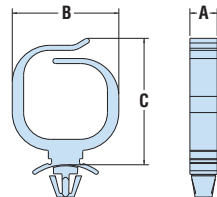

Style 2

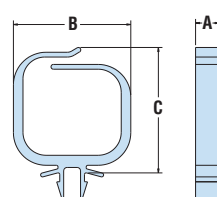

Style 3

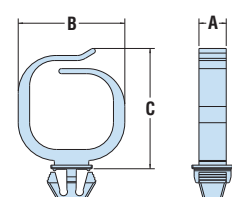

Style 4

	Split Dart	Optical Fiber
Material	Nylon 6/6	Nylon 6/6
Flammability Rating	94V-2	94V-2 and 94V-0
Temperature Range	-40°F (-40°C) to 185°F (85°C)	32°F (0°C) to 185°F (85°C) (94V-2) 32°F (0°C) to 203°F (95°C) (94V-0)

Quick Specs

- Split dart feature allows user to easily slip the cable holder over the cable which is held firmly in place once inserted into the mounting hole.
- Designed to hold a single cable or wire bundles.



- Smooth, rounded corners eliminate stress on delicate fiber optic wires.
- Gather and route fiber optic wires.
- Available for round and square mounting holes.





- Smooth, radiused edges ensure that Nytyes won't cut into the cable's insulation—or the installer's hand.
- One-piece design reduces cost and installation time.
- Nytyes feature a bent tip for ease of pickup and insertion around small bundles. V-shaped raised ridges on the tip provide a sure grip.
- Close, evenly spaced teeth permit fine adjustment—from .025" (0,6 mm) on the smallest Nytyes to .063" (1,6 mm) on the largest.
- Compliant with MS3367 and MIL-S-23190E

Heyco® Nytye® Nylon Cable Ties

PART SPECIFICATIONS				PART NO.		DESCRIPTION	PART DIMENSIONS			
Max. Tensile Strength		Max. Bundle Diameter		Natural	UV Black		A Length		B Width	
Lbs.	N	in.	mm.			in.	mm.	in.	mm.	
Miniature										
18	80	.63	16,0	13100	13100B	NT-18-031	3.15	80	.10	2,5
		.87	22,0	13102	13102B	NT-18-039	3.94	100		
		1.18	30,0	13105	13105B	NT-18-047	4.72	120		
		1.38	35,0	13107	13107B	NT-18-059	5.91	150		
		1.57	40,0	13108	13108B	NT-18-063	6.30	180		
		2.36	60,0	13111	13111B	NT-18-078	7.87	200		
Intermediate										
40	178	.87	22,0	13120	13120B	NT-40-039	3.94	100	.14	3,6
		1.18	30,0	13121	13121B	NT-40-047	4.72	120		
		1.30	33,0	13122	13122B	NT-40-055	5.51	140		
		1.38	35,0	13123	13123B	NT-40-059	5.91	150		
		1.65	42,0	13124	13124B	NT-40-070	7.09	180		
		1.97	50,0	13126	13126B	NT-40-078	7.87	200		
		2.56	65,0	13128	13128B	NT-40-099	9.92	252		
		3.15	80,0	13129	13129B	NT-40-110	11.02	280		
		3.35	85,0	13130	13130B	NT-40-118	11.81	300		
		4.02	102,0	13134	13134B	NT-40-145	14.57	370		
Standard										
50	222	.94	24,0	13140	13140B	NT-50-047	4.72	120	.19	4,8
		1.57	40,0	13142	13142B	NT-50-063	6.30	160		
		1.65	42,0	13143	13143B	NT-50-072	7.20	183		
		1.97	50,0	13145	13145B	NT-50-078	7.87	200		
		2.56	65,0	13147	13147B	NT-50-098	9.84	250		
		2.76	70,0	13149	13149B	NT-50-110	11.02	280		
		3.23	82,0	13151	13151B	NT-50-118	11.81	300		
		3.54	90,0	13153	13153B	NT-50-137	13.78	350		
		4.02	102,0	13155	13155B	NT-50-145	14.57	370		
		4.13	105,0	13156	13156B	NT-50-157	15.75	400		
		5.12	130,0	13158	13158B	NT-50-177	17.72	450		
		5.91	150,0	13160	13160B	NT-50-196	19.68	500		

Standard colors natural and UV Black. Consult Heyco for heat-stabilized material and colors.

Heyco® Cable Tie Tensioning Tool



Part No. 0998 fits all standard duty Nytyes. Metal construction, has three tension settings, and automatically trims excess.

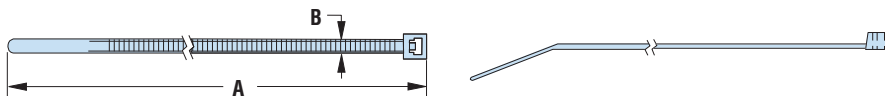

Quick Specs

Material	Nylon 6/6
Certifications	 Certified by UL for Compliance with both Canadian and U.S. requirements under File E54523
Flammability Rating	94V-2
Temperature Range	-40°F (-40°C) to 185°F (85°C)



Heyco® Nytye® Heavy Duty and Extra Heavy Duty/HVAC Nylon Cable Ties

PART SPECIFICATIONS				PART NO.		DESCRIPTION	PART DIMENSIONS			
Max. Tensile Strength		Max. Bundle Diameter		Natural	UV Black		A Length		B Width	
Lbs.	N	in.	mm.			in.	mm.	in.	mm.	
Heavy Duty										
120	534	1.30	33.0	13172	13172B	NT-120-059	5.91	150	.30	7.6
		1.97	50.0	13175	13175B	NT-120-078	7.87	200		
		2.48	63.0	13178	13178B	NT-120-098	9.84	250		
		3.23	82.0	13181	13181B	NT-120-118	11.81	300		
		3.54	90.0	13183	13183B	NT-120-137	13.78	350		
		3.98	101.0	13185	13185B	NT-120-149	14.96	380		
4.13	105.0	13186	13186B	NT-120-157	15.75	400				
Extra Heavy Duty/HVAC										
175	778	7.48	190.0	13208	13208B	NT-175-256	25.59	650	.35	9.0
		9.65	245.0	13215	13215B	NT-175-315	31.50	800		
		10.67	271.0	13217	13217B	NT-175-362	36.22	920		
		11.42	290.0	13218	13218B	NT-175-394	39.37	1000		
		14.49	368.0	13220	13220B	NT-175-482	48.23	1225		

Standard colors natural and UV Black. Consult Heyco for heat-stabilized material and colors.

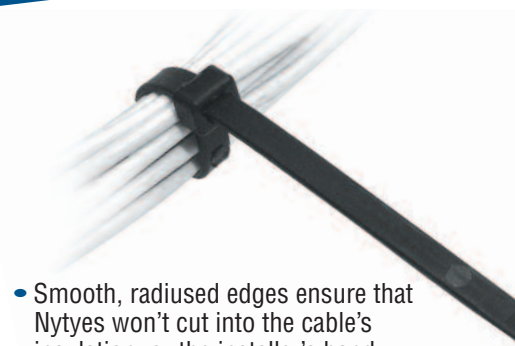
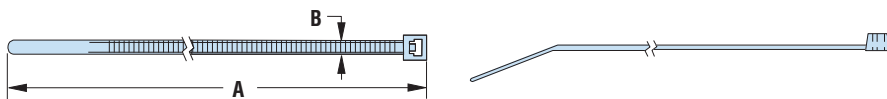

- Smooth, radiused edges ensure that Nytyes won't cut into the cable's insulation—or the installer's hand.
- One-piece design reduces cost and installation time.
- Nytyes feature a bent tip for ease of pickup and insertion around small bundles. V-shaped raised ridges on the tip provide a sure grip.
- Close, evenly spaced teeth permit fine adjustment—from .025" (0,6 mm) on the smallest Nytyes to .063" (1,6 mm) on the largest.
- Compliant with MS3367 and MIL-S-23190E



Heyco® Nytye® Double Loop Cable Ties

PART SPECIFICATIONS					PART NO.	DESCRIPTION	PART DIMENSIONS				
Max. Tensile Strength		Max. Bundle Diameter 1	Max. Bundle Diameter 2	Natural			A Length		B Width		
Lbs.	N	in.	mm.	in.	mm.	in.	mm.	in.	mm.		
50	222	1.85	47,0	1.77	45,0	13320	NTDL-050-076	7.68	195	.19	4,8
		2.32	59,0	2.05	52,0	13321	NTDL-050-088	8.86	225		
		3.27	83,0	2.99	76,0	13323	NTDL-050-118	11.81	300		
		4.13	105,0	3.86	98,0	13324	NTDL-050-145	14.56	370		

Standard color natural.

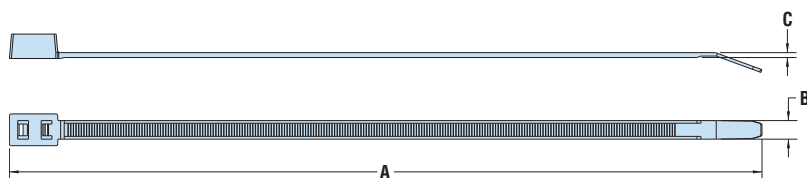

- Cost-effective way to secure and separate two bundles with one cable tie
- Quickly and easily pulls through increasing productivity
- Single part covers multiple bundle sizes resulting in reduced part number inventory

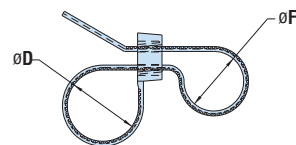

Material: Nylon 6/6
 Certifications: Certified by UL for Compliance with both Canadian and U.S. requirements under File E54523 (NT parts only)
 Flammability Rating: 94V-2
 Temperature Range: -40°F (-40°C) to 185°F (85°C)

Quick Specs



Heyco® Nytye® Push Mount Nylon Cable Ties

PART SPECIFICATIONS				PART NO.		DESCRIPTION	PART DIMENSIONS										STYLE
Max. Tensile Strength		Max. Bundle Diameter		Natural	UV Black		A Length		B Width		C Spacer Height		Max. Panel Thickness		Mounting Hole Dia.		
Lbs.	N	in.	mm.			in.	mm.	in.	mm.	in.	mm.	in.	mm.	in.	mm.		
Tension Wings																	
40	178	1.42	36,0	-	3907†	PWMS-155-HSB	6.23	158	.14	3,5	-	-	.09	2,3	.187	4,7	1
50	222	1.57	40,0	13254	13254B	PMT-50-070	7.09	180	.19	4,8	-	-	.09	2,4	.187	4,7	2
		1.75	44,5	3904	3905	PMT 150	8.00	203	.19	4,8	-	-	.13	3,2	.250	6,4	1
Tension Wings, Standoff																	
18	80	.75	19,1	13262	13262B	PMST-18-050-156	5.04	128	.10	2,5	.24	6,1	.08	2,0	.156	4,0	3
40	178	1.38	35,0	13267	13267B	PMST-40-066-197	6.69	170	.14	3,6	.51	13,0	.08	2,0	.197	5,0	
		1.25	31,8	13268	13268B	PMST-40-068-187	6.81	173	.14	3,6	.78	19,8	.08	2,0	.187	4,7	
Cupped Base, Standoff, Releasable																	
30	133	1.25	31,8	13273	13273B	PMRS-30-066	6.63	168	.14	3,6	.53	13,5	.023 - .098	0,6 - 2,5	.236 - .255	6,0 - 6,5	4

NEW!

Standard color natural and UV Black. Consult Heyco for heat-stabilized material and colors.

† cURus

Style 1

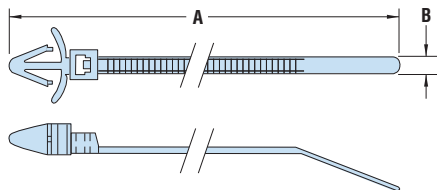

Style 3

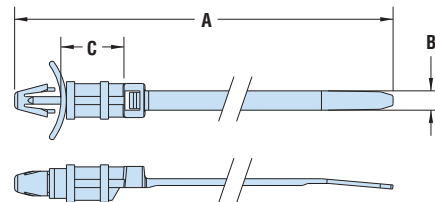

Style 2

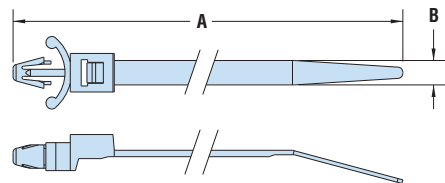

Style 4

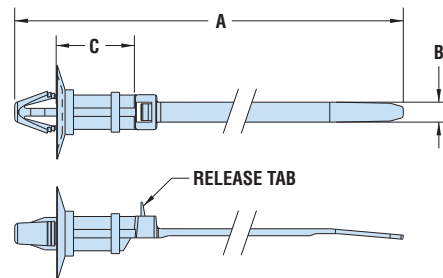

Quick
Specs

Material Nylon 6/6
 Flammability Rating 94V-2
 Temperature Range -40°F (-40°C) to 185°F (85°C)

“Stay Connected” with



HEYware

a PennEngineering® Company

Heyco® Nytye® Nylon Cable Tie Variations

PART SPECIFICATIONS				PART NO.		DESCRIPTION	PART DIMENSIONS			
Max. Tensile Strength	Max. Bundle Diameter	Natural	UV Black				A Length	B Width		
Lbs.	N	in.	mm.			in.	mm.	in.	mm.	

Low Profile

65	289	5.91	150	13294	13294B	NLTP-65-097	19.68	500	.35	9,0
----	-----	------	-----	-------	--------	-------------	-------	-----	-----	-----

Releasable

40	178	1.38	35,0	13297	13297B	RNT-40-059	5.94	151	.14	3,5
50	222	1.97	50,0	13301	13301B	RNT-50-079	7.95	202	.18	4,5
100	444	2.87	73,0	13302	13302B	RNT-100-098	9.84	250	.30	7,5

Screw Mount

										Screw Size	
18	80	.87	22,0	13307	-	MNT-18-044	4.41	112	.10	2,5	#4 screw
40	178	1.38	35,0	13308	-	MNT-40-067	6.69	170	.14	3,6	#8 screw
50	222	1.75	44,4	3560*	-	MNT-150	8.00	203	.19	4,8	#10 screw
		1.97	50,0	13309	-	MNT-50-086	8.66	220	.17	4,3	

Identification

										Marking Area W x L				
										in.	mm.	in.	mm.	
18	80	.87	22,0	13316	-	NTID-18-039	3.94	100	.10	2,5	.31	8,0	1.00	25,4

Standard color natural and UV Black. Consult Heyco for heat-stabilized material and colors.
*cURus

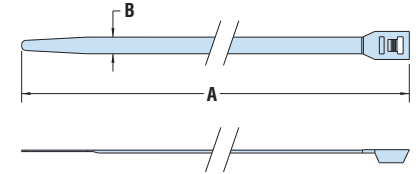

Low Profile

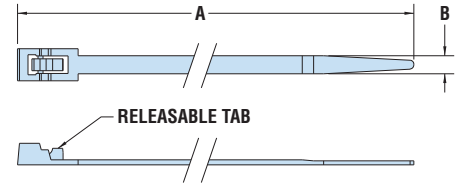

Releasable

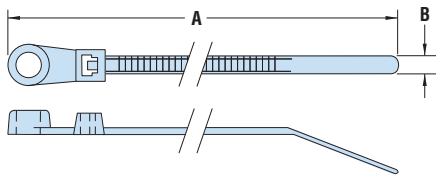

Screw Mount

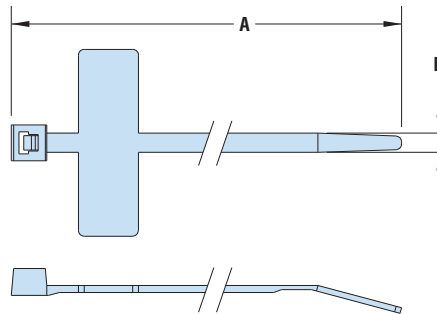

Identification

Material	Nylon 6/6
Certifications	Certified by Underwriters' Laboratories for compliance with both Canadian and US Requirements under File E54523 (Releasable and Screw Mount Nytyes only)
Flammability Rating	94V-2
Temperature Range	32°F (0°C) to 185°F (85°C)

Quick Specs



Heyco® Nytye® Mounting Platforms

Flat Platforms – Adhesive Back Mount

- Multiple sizes, strengths, and mounting options anchor Nytyes® securely.
- Five Types:
 - 1) Flat - Adhesive-Back and Screw Mounts
 - 2) Saddle - Screw Mount only
 - 3) Push Mount - Arrowhead and Blind Mounts
 - 4) Snap Over Bolt
 - 5) Stainless Steel Edge Clip "SunRunner Series"

	MAX. TENSILE STRENGTH		ADHESIVE	INSERT POINTS	RELEASE TAB?	PART NO.	DESCRIPTION	PART DIMENSIONS					
	Lbs.	N						A		B		C	
								in.	mm.	in.	mm.	in.	mm.
NEW!	18	80	Rubber Acrylic	4	yes	3591 3591A	MP-050x050-ABR MP-050x050-ABA	.50	12,7	.50	12,7	.17	4,3
NEW!	40	178	Rubber Acrylic	4	yes	3595 3595A	MP-075x075-ABR MP-075x075-ABA	.75	19,1	.75	19,1	.28	7,0
NEW!			Rubber Acrylic	4	yes	3594 3594A	MP-080x080-ABR MP-080x080-ABA	.80	20,3	.80	20,3	.19	4,8
NEW!	50	222	Rubber	2	yes	3599 3599A	MP-100x100-ABR MP-100x100-ABA	1.00	25,4	1.00	25,4	.32	8,1
			Rubber	4	yes	3590* 3593*	MP-110x110-ABA MP-115x115-ABA	1.10 1.15	27,9 29,2	1.10 1.15	27,9 29,2	.24 .26	6,0 6,6

Standard color natural. *These adhesive-backed parts are also screw mountable.

Flat Platforms – Screw Mount

- Rubber based adhesive effective up to 158°F (70°C).
- Acrylic based adhesive effective up to 167°F (75°C).
- Apply Adhesive-Backed parts to a clean, dry surface.

	MAX. TENSILE STRENGTH		SCREW SIZE		INSERT POINTS	PART NO.	DESCRIPTION	PART DIMENSIONS					
	Lbs.	N	in.	mm.				A		B		C	
								in.	mm.	in.	mm.	in.	mm.
	40	178	#6	3,5	4	4264	MP-075x075-S6	.75	19,1	.75	19,1	.24	6,0
	50	222	#8	4,0	4	4265 3589	MP-038x075-S8 MP-100x100-S8	.38	9,5	.75	19,1	.20	5,0
NEW!					NEW!	2	3580	MP-110x110-S8	1.10	27,9	1.10	27,9	.24
			#6	3,5	4	3581	MP-115x115-S6	1.15	29,2	1.15	29,2	.26	6,6

Standard color natural.

Tensile Lbs.	Width	
	in.	mm.
18	.10	2,5
40	.14	3,6
50	.19	4,8
120	.30	7,6

Saddle Platforms – Screw Mount

	MAX. TENSILE STRENGTH		SCREW SIZE		INSERT POINTS	PART NO.	DESCRIPTION	PART DIMENSIONS					
	Lbs.	N	in.	mm.				A		B		C	
								in.	mm.	in.	mm.	in.	mm.
	18	80	#4	3,0	2	4269	MP S-4	.51	13,0	.33	8,3	.24	6,1
	50	222	#8	4,0	2	3759	MP S-8	.60	15,2	.38	9,7	.28	7,0
	120	534	#10	5,0	2	3753	MP S-10	.87	22,2	.62	15,7	.39	9,9

Standard color natural.

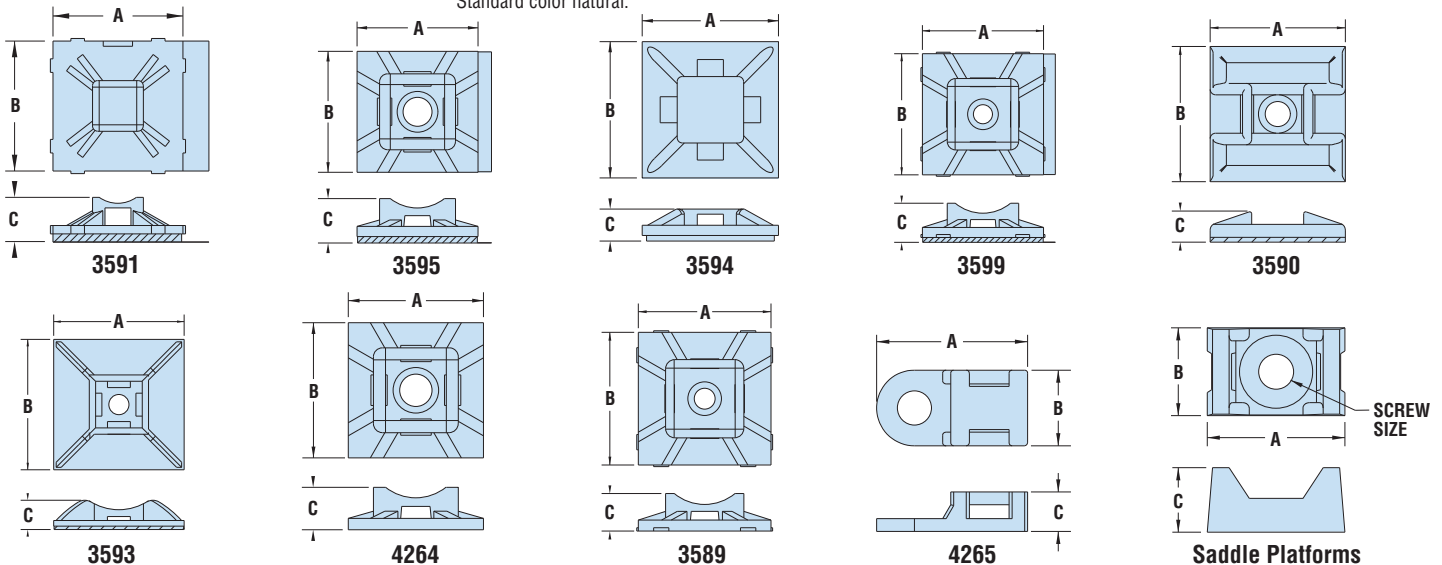

Material
Certifications
Flammability Rating
Temperature Range

Nylon 6/6
 Recognized under the Component Program of Underwriters' Laboratories File E54523 (Adhesive-Back Mount parts only)
 94V-2
 -32°F (0°C) to 158°F (70°C) (Rubber adhesive backed)
 -32°F (0°C) to 167°F (75°C) (Acrylic adhesive backed)
 32°F (0°C) to 185°F (85°C) (Non-adhesive backed)

Heyco® Nytye® Mounting Platforms

Push Mount Platforms

MAX. TENSILE STRENGTH		MOUNTING HOLE DIA.		MAX. PANEL THICKNESS*		INSERT POINTS	PART NO.	DESCRIPTION	PART DIMENSIONS					
Lbs.	N	in.	mm.	in.	mm.				A		B		C	
Arrowhead Mount														
50	222	.19	4,8	.08	2,0	2	4266	MP PM-19	.56	14,3	.24	6,1	.63	15,9
		.25	6,4	.11	2,8	2	3762	MP PM-25	.63	15,9	.28	7,1	.69	17,5
		.26	6,7	.35	9,0	2	4267	MP PM-26	.80	20,2	.31	7,9	.82	20,9
Blind Head Mount*														
40	178	.31	7,9	.25	6,4	2	4268	MP PMB-31	.43	11,0	.33	8,3	.52	13,1
Reverse Button Mount														
50	222	.25	6,4	.13	3,2	2	3592	MP R-2	.42	10,7	.15	3,8	.41	10,3

*Minimum Panel Thickness for Blind Mount Platforms

Snap Over Bolt Platform

MAX. TENSILE STRENGTH		INSERT POINTS	BOLT SIZE		PART NO.	DESCRIPTION	PART DIMENSIONS						
Lbs.	N		in.	mm.			Black	A		B		C	
NEW! NEW!	120	534	2	1/2	12,0	3710	MP S-1/2	2.31	58,7	1.25	31,8	1.05	26,7
				9/16	14,0	3711	MP S-9/16						
				5/8	16,0	3754	MP S-5/8						

Standard color black.

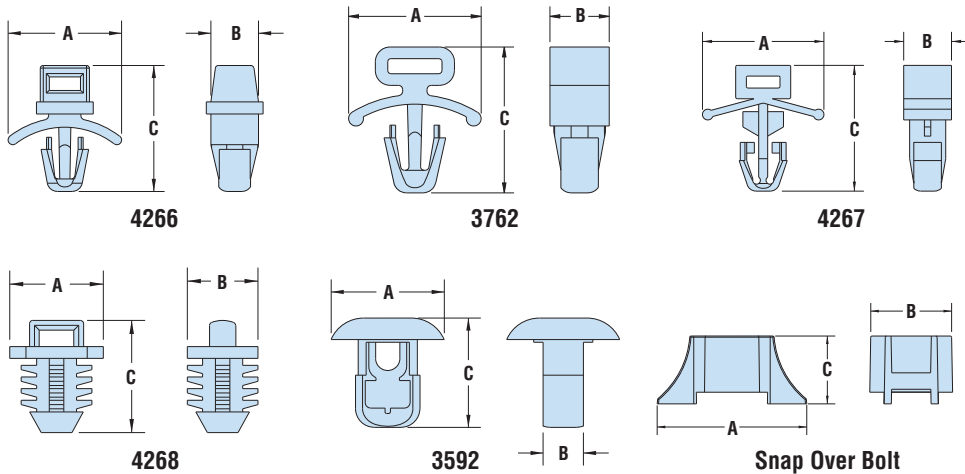

Stainless Steel Edge Clip Platform

ALL NEW PRODUCTS

MAX. CABLE TIE WIDTH*		PANEL THICKNESS RANGE		INSERT POINTS	PART NO.	DESCRIPTION	PART DIMENSIONS							
in.	mm.	Minimum	Maximum				A		B		C			
.31	8,0	.06	1,5	.12	3,0	4	S6474	SunRunner CT	1.03	26,2	.63	16,0	.77	19,5
		.12	3,0	.25	6,4	4	S6475	SunRunner CT-EZ						

*Edge Clip Platforms SunRunner CT and CT-EZ fit all Heyco Stainless Steel Cable Ties, see page 7-69

Material .025" Thick 304 stainless steel (CT & CT-EZ)
 Certifications Certified by UL for Compliance with both Canadian and US Requirements under File E54523



- Multiple sizes, strengths, and mounting options anchor Nytyes® securely.
- Five Types:
 - 1) Flat - Adhesive-Back and Screw Mounts
 - 2) Saddle - Screw Mount only
 - 3) Push Mount - Arrowhead and Blind Mounts
 - 4) Snap Over Bolt
 - 5) Stainless Steel Clip
- Rubber based adhesive effective up to 126°F (52°C).
- Apply Adhesive-Backed parts to a clean, dry surface.
- For Push Mount and Snap Over Bolt Platform Quick Specs, see page 7-68.

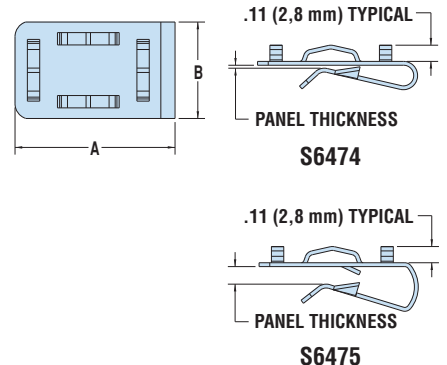

“Stay Connected” with



HEYware

a PennEngineering® Company



- Non-magnetic stainless steel locking device for maximum strength.
- Notch-free tie design provides for precise locking positions.
- Serrated finger grip tail reduces slippage during installation.
- Stronger and lower profile than notched body ties.
- Rounded edge design protects cable insulation.
- Part Description Key: NTMP-XXX-YYY where XXX = tensile (foot pounds) and YYY = length (inches x 10)

Heyco® Nytyes® with Stainless Steel Locking Device

PART SPECIFICATIONS				PART NO.		DESCRIPTION	PART DIMENSIONS					
Min. Tensile Strength		Max. Bundle Diameter		Natural	Black		A Length		B Width		C Thickness	
Lbs.	N	in.	mm.			in.	mm.	in.	mm.	in.	mm.	
18	80	.87	22,0	13000	13000B	NTMP-018-039	3.90	100	.12	3,0	.04	1,1
35	160	1.42	36,0	13001	13001B	NTMP-036-059	5.90	150	.16	4,0	.05	1,2
		2.09	53,0	13002	13002B	NTMP-036-079	7.90	200				
45	200	2.56	65,0	13003	13003B	NTMP-045-098	9.80	250	.20	5,0	.06	1,5
		2.99	76,0	13004	13004B	NTMP-045-118	11.80	300				
56	250	2.09	53,0	13008	13008B	NTMP-056-079	7.90	200	.31	8,0		
		2.60	66,0	13009	13009B	NTMP-056-094	9.40	240				
		2.99	76,0	13010	13010B	NTMP-056-118	11.80	300				
112	500	2.99	76,0	13011	13011B	NTMP-112-118	11.80	300				
		3.74	95,0	13012	13012B	NTMP-112-138	13.80	350				
124	550	4.45	113,0	13013	13013B	NTMP-112-157	15.70	400	.39	10,0	.07	1,7
		4.72	120,0	13014	13014B	NTMP-124-177	17.70	450				
		6.22	158,0	13015	13015B	NTMP-124-197	19.70	500				

Standard colors natural and UV Black.

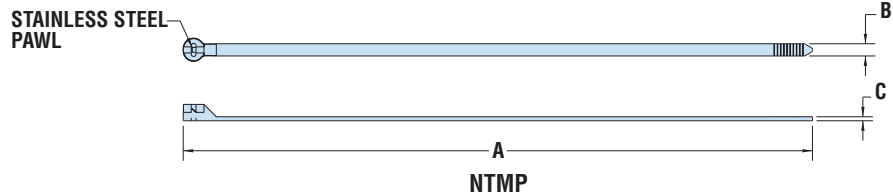

Material	Nylon 6/6 Wire Tie with a Stainless Steel Locking Pawl
Flammability Rating	94V-2
Temperature Range	-40°F (-40°C) to 185°F (85°C)



Lower Cost Bulk Pack Available!

UL APPROVED

Heyco® Heavy Duty Stainless Steel Wire Cable Ties

- Extremely durable, vinyl jacketed Stainless Steel Cable Tie.
- Smooth vinyl jacketing prevents damage to installation cable insulation.
- Stainless steel crimp sleeve for easy field installation with electrician linesmen pliers, or wire cutters.
- Certified by UL Specification 62275 for indoor and outdoor usage.
- UV protected vinyl jacket is excellent for solar installation where product durability is required.
- Use standard wire cutters to both crimp the sleeve and cut the excess wire.
- Covered by the Heyco Twenty Year Solar Warranty, visit solar power components section at Heyco.com.
- DFARS Compliant

PART SPECIFICATIONS				PART NO.		DESCRIPTION	PART DIMENSIONS			
Max. Tensile Strength		Max. Bundle Diameter		100 Pack	Bulk		A Length		B Diameter	
lbs.	N	in.	mm.			in.	mm.	in.	mm.	
Black vinyl jacketed 302/304 stainless steel wire										
100	440	2.30	58,4	S6408	S6409	SunBundler® 8	8	203	.06	1,6
		2.92	74,2	S6410	S6411	SunBundler® 10	10	254		
		3.88	98,6	S6412	S6413	SunBundler® 12	12	305		
		4.20	106,7	S6414	S6415	SunBundler® 14	14	356		
		6.36	161,5	S6420	S6421	SunBundler® 20	20	508		

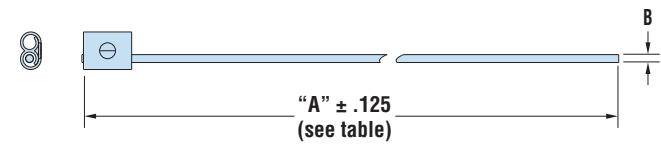

Material	Commercial Aircraft Grade 302/304 stainless wire w/UV protected vinyl jacket
Certifications	Certified by Underwriters' Laboratories for Compliance with both Canadian and U.S. Requirements under File E54523
Temperature Range	-40°F (-40°C) to 221°F (105°C)

Heyco® Stainless Steel Cable Ties

Ball Lock Stainless Steel Strip Cable Ties - Standard and PVC Coated

PART SPECIFICATIONS				PART NO.		DESCRIPTION	PART DIMENSIONS							
Min. Tensile Strength		Max. Bundle Diameter		Standard Steel	PVC Coated Black		A Length		B Width					
Lbs.	N	in.	mm.			in.	mm.	in.	mm.					
AISI 304														
112	500	1.18	30,0	12801	12801B	NTSS-0150-46A	5.91	150,0	.18	4,6				
		2.05	52,0	12802	12802B	NTSS-0200-46A	7.87	200,0						
		2.68	68,0	12803	12803B	NTSS-0250-46A	9.84	250,0						
		3.23	82,0	12805	12805B	NTSS-0300-46A	11.81	300,0						
		3.86	98,0	12806	12806B	NTSS-0350-46A	13.78	350,0						
		4.33	110,0	12808	12808B	NTSS-0400-46A	15.75	400,0						
		5.75	146,0	12810	12810B	NTSS-0500-46A	19.69	500,0						
		7.09	180,0	12812	12812B	NTSS-0600-46A	23.62	600,0						
9.50	240,0	12814	12814B	NTSS-0800-46A	31.50	800,0								
250	1115	2.05	52,0	12821	12821B	NTSS-0200-79A	7.87	200,0	.31	7,9				
		2.68	68,0	12822	12822B	NTSS-0250-79A	9.84	250,0						
		3.23	82,0	12824	12824B	NTSS-0300-79A	11.81	300,0						
		3.86	98,0	12825	12825B	NTSS-0350-79A	13.78	350,0						
		4.33	110,0	12827	12827B	NTSS-0400-79A	15.75	400,0						
		5.75	146,0	12829	12829B	NTSS-0500-79A	19.69	500,0						
		7.09	180,0	12831	12831B	NTSS-0600-79A	23.62	600,0						
		8.27	210,0	12833	12833B	NTSS-0700-79A	27.56	700,0						
		9.50	240,0	12834	12834B	NTSS-0800-79A	31.50	800,0						
		12.09	307,0	12836	12836B	NTSS-1000-79A	39.37	1000,0						
		AISI 316												
		112	500	1.18	30,0	12851	12851B	NTSS-0150-46B			5.91	150,0	.18	4,6
2.05	52,0			12852	12852B	NTSS-0200-46B	7.87	200,0						
2.68	68,0			12853	12853B	NTSS-0250-46B	9.84	250,0						
3.23	82,0			12855	12855B	NTSS-0300-46B	11.81	300,0						
3.86	98,0			12856	12856B	NTSS-0350-46B	13.78	350,0						
4.33	110,0			12858	12858B	NTSS-0400-46B	15.75	400,0						
5.75	146,0			12860	12860B	NTSS-0500-46B	19.69	500,0						
7.09	180,0			12862	12862B	NTSS-0600-46B	23.62	600,0						
9.50	240,0	12864	12864B	NTSS-0800-46B	31.50	800,0								
250	1115	2.05	52,0	12871	12871B	NTSS-0200-79B	7.87	200,0	.31	7,9				
		2.68	68,0	12872	12872B	NTSS-0250-79B	9.84	250,0						
		3.23	82,0	12874	12874B	NTSS-0300-79B	11.81	300,0						
		3.86	98,0	12875	12875B	NTSS-0350-79B	13.78	350,0						
		4.33	110,0	12877	12877B	NTSS-0400-79B	15.75	400,0						
		5.75	146,0	12879	12879B	NTSS-0500-79B	19.69	500,0						
		7.09	180,0	12881	12881B	NTSS-0600-79B	23.62	600,0						
		8.27	210,0	12883	12883B	NTSS-0700-79B	27.56	700,0						
		9.50	240,0	12884	12884B	NTSS-0800-79B	31.50	800,0						
		12.09	307,0	12886	12886B	NTSS-1000-79B	39.37	1000,0						

NEW PRODUCT



- For ease of assembly, position locking head so the widest end is down.
- Part Description Key: NTSS-XXXX-YYA where XXXX = length (mm) and YYA = width (mm) with A indicating AISI 304 stainless steel and B indicating AISI 316 stainless steel.
- Stainless steel cable ties have more strength and better durability than nylon cable ties.
- Locking ball design for maximum holding strength and ease of installation.
- Coated ties offer additional protection and separation of dissimilar metals for improved corrosion resistance.
- Suitable for harsh outdoor environments; conform to standard IEC92 for Marine Electrical Appliances and the requirements of CB1113-85 “Plastic Covered Metal Cable Ties”, “Steel Sea Boats Construction Level Standard.”
- Secure bundles in moist and high temperature environments with decay, fire, corrosion, and radio resistance.
- Widely used in shipping, communication, and flight applications.
- .010" (0,25 mm) thick.
- Custom lengths available.
- 100 pack standard.

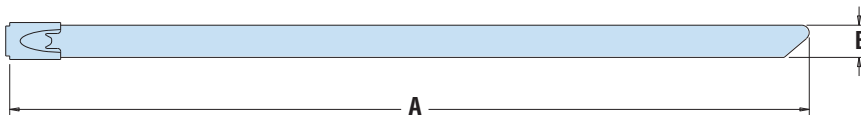

NTSS

Materials

AISI 304 or 316 stainless steel with PVC coating

Quick Specs



Heyco® Edge Clips

Edge Clips Unassembled or Assembled with 8" Cable Tie

- Ideal for use where holes cannot be used or where adhesives are unacceptable due to temperature issues.
- Applies easily to plastic and metal without the need for a mounting hole.
- Ideal for assembly usage. Clip provides low insertion force and high extraction.
- Two piece assembly allows the clip to slide along the strap ensuring proper orientation.
- For Acetal Cable ties add “A” to the Assembled Part No.; eg 14275A.

UNASSEMBLED EDGE CLIP			EDGE CLIP ASSEMBLED WITH CABLE TIE			ASSEMBLED NYTYE CABLE TIE					
Fixing	Part No. Black	Desc.	Cable Tie Orientation	Part No. Black	Description	Tensile Strength		Max. Bundle Diameter		Overall Length	
						Lbs.	N	in.	mm.	in.	mm.
For Panels from .04" (1,0 mm) to .12" (3,0 mm) Thick											
Top	14267	NTEC1-TB	Perpendicular	14275	NTEC1-TP-50-078	50	222	1.77	45,0	7.87	200
			Parallel	14276	NTEC1-TL-50-078						
Side	14268	NTEC1-SB	Perpendicular	14277	NTEC1-SP-50-078	50	222	1.77	45,0	7.87	200
			Parallel	14278	NTEC1-SL-50-078						
For Panels from .12" (3,0 mm) to .24" (6,0 mm) Thick											
Top	14270	NTEC2-TP	Perpendicular	14280	NTEC2-TP-50-078	50	222	1.77	45,0	7.87	200
	14271	NTEC2-TL	Parallel	14281	NTEC2-TL-50-078						
Side	14272	NTEC2-SP	Perpendicular	14282	NTEC2-SP-50-078	50	222	1.77	45,0	7.87	200
	14273	NTEC2-SL	Parallel	14283	NTEC2-SL-50-078						

Standard color black.

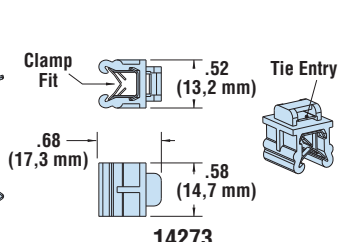
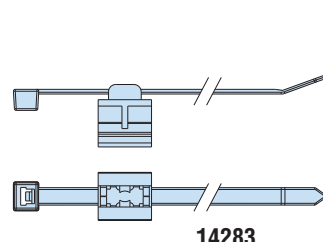
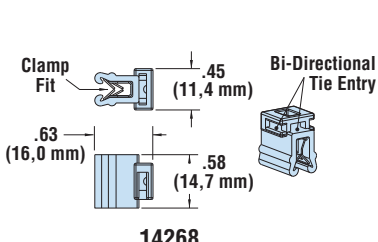
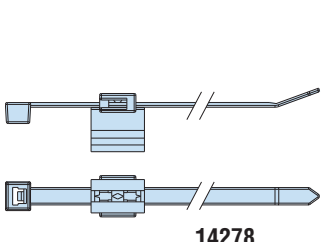
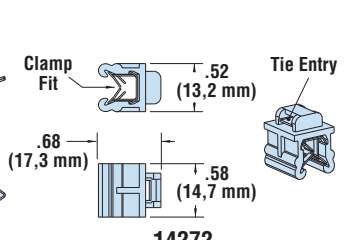
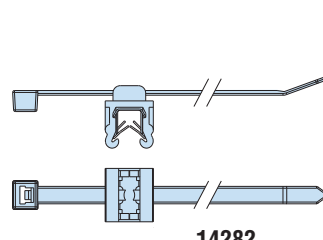
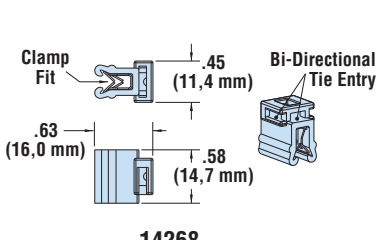
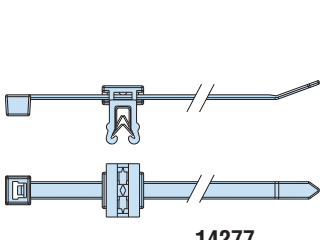
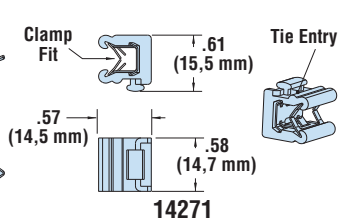
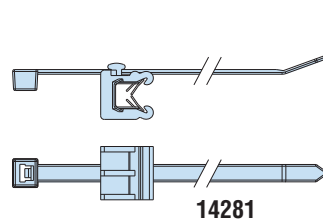
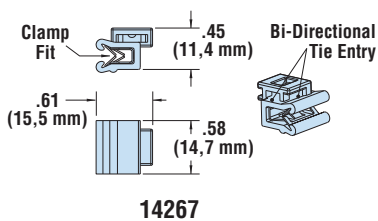
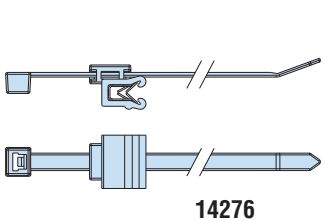
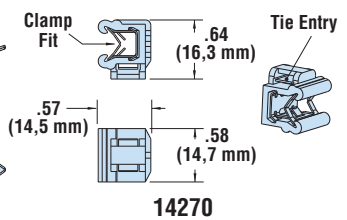
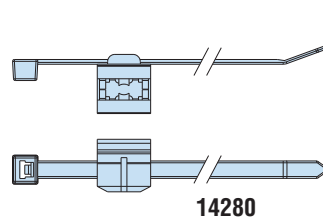
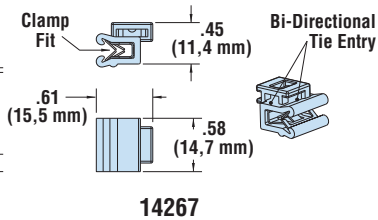
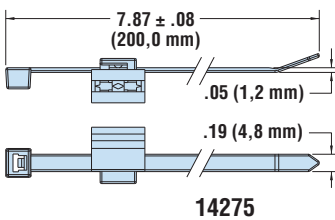

Material	Nylon 6/6 high impact modified, heat and UV stabilized
Flammability Rating	94V-2
Temperature Range	-40°F (-40°C) to 221°F (105°C)

Heyco® Beaded Ties

TENSILE STRENGTH		MAXIMUM BUNDLE DIAMETER		DESC.	PART NUMBERS						
Lbs.	N	in.	mm.		NYLON		POLYETHYLENE				
					Black	Natural	Black	Natural	Blue	Red	Yellow
Standard											
10	45	1-1/8	28,6	BT 4	3509	3490	3419	3420	3421	3422	3423
		1-3/8	35,0	BT 5	3519	3491	3424	3425	3426	3427	3428
18	80	1-7/8	48,0	BT 6	3523	3492	3429	3430	3431	3432	3433
		2-1/2	64,0	BT 8	3524	3493	3434	3435	3436	3437	3438
		3	76,0	BT 10	3495	3494	3439	3440	3441	3442	3443
		4	101,6	BT 14	3498	3496	3484	3480	3476	3482	3483
Nylon Push Mount*											
40	180	1-3/8	35,0	PBT 5	3499B	3499					

Standard colors: PE-black, natural, blue, red, and yellow. N-Black and natural.

*Mounts into a .250" (6,4 mm) diameter hole, maximum panel thickness .142" (3,6 mm).

Mounting Platform for Beaded Ties

- Part No. **3750**
- Adhesive backed
- May also be screw mounted
- Molded of natural nylon.
- Consult Heyco for other colors

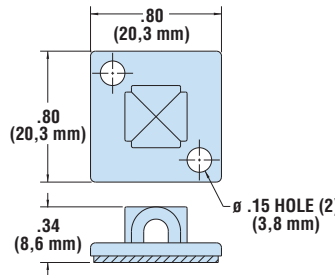
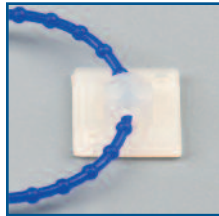

- **Releasable and reusable** ties for easy bundling, closing, bagging, holding, and tying.
- Polyethylene for high flexibility and moderate strength.
- Multiple sizes for bundles up to 4" (101,6 mm) diameter.

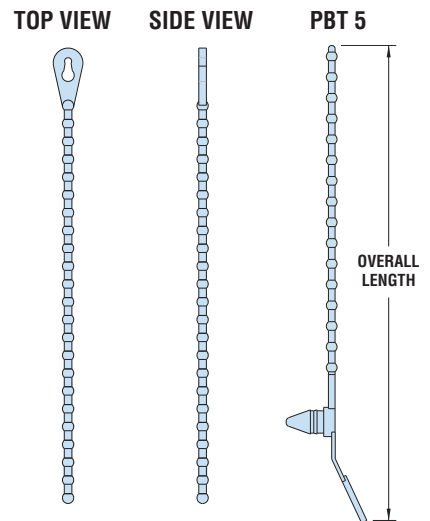

Heyco® Braided Sleeving

BUNDLE RANGE				PART NO.		DESCRIPTION	PART DIMENSIONS			
Minimum Diameter		Maximum Diameter		Black	FR Black		Nominal Diameter		Quantity Per Spool	
in.	mm.	in.	mm.			in.	mm.	ft.	mtrs.	
.09	2,3	.25	6,4	8980	8983	BS 125	.13	3,2	1000	305
.13	3,2	.44	11,1	8985	8988	BS 250	.25	6,4	500	152
.25	6,4	.75	19,1	8990	8993	BS 500	.50	12,7	250	76
.50	12,7	1.25	31,8	8995	8998	BS 750	.75	19,1	200	61
.75	19,1	1.75	44,5	9000	9003	BS 1250	1.25	31,8		
1.25	31,8	2.75	69,9	9005	9008	BS 1750	1.75	44,5		
1.50	38,1	3.50	88,9	9010	9013	BS 2.0	2.00	50,8		

Standard color black.

FR sleeving flammability rating-UL VW-1.



- **Braided sleeve slips on quickly and is self-fitting** over irregular shapes and contours. No wire pulling compounds are required due to its low surface friction. Slight tensioning after application makes for an even tighter fit.
- Expandable up to three times its own diameter, the open-weave construction can fit many applications, simplifying inventory. The open-weave allows for easy inspection of sleeved components and easy break out of individual cables.
- Full cable flexibility is maintained in any direction, even at low temperatures. Wires encased in Heyco Braided Sleeving can flex and bend as readily as if they had no protective oversleeving. Bundles can be flexed repeatedly without damage.
- Tough, cut-resistant sleeving is designed for protecting wire bundles and harnesses, hoses, tubing, and cable assemblies from mechanical damage and environmental hazards.
- Preferred cutting method: hot knife.

Beaded Ties		Braided Sleeving	
Material	Polyethylene or Nylon	Materials	Polyester Monofilament Yarns or Flame Retardant Polyester Yarn
Flammability Rating	94V-2	Certifications	Recognized under the Component Program of Underwriters' Laboratories File E173954
Temperature Range	40°F (0°C) to 221°F (85°C)	Monofilament Dia.	.010"
		Temperature Range	-103°F (-75°C) to 257°F (125°C)



- Easy to use: Just twist on wire!
- Allows breakouts of single/multiple wires and re-routing of replacement wires.
- Absorbs vibration, insulates cables and hose, and resists abrasion.
- Multiple sizes bundle and protect cables, wires, tubing, and hoses from .13” (3,2 mm) to 7.00” (177,8 mm) diameters.
- Conforms to: Fed Spec LP390, Mil I-631D, Mil P-21922B
- For hose and cable **clamps** see pages 36 through 43.

Heyco® Hose and Cable Wrap-Polyethylene

Standard

BUNDLE RANGE				PART NO.		DESCRIPTION	PART DIMENSIONS					
Minimum Diameter		Maximum Diameter		UV Black	Natural		A Outside Diameter		B Pitch		C Thickness	
in.	mm.	in.	mm.			in.	mm.	in.	mm.	in.	mm.	
.13	3,2	1.50	38,1	8904	8905	CW 187 PE*	.19	4,8	.25	6,3	.03	0,8
.19	4,8	2.00	50,8	8908	8909	CW 250 PE	.25	6,3	.38	9,5	.05	1,1
.31	7,9	3.00	76,2	8912	8913	CW 375 PE	.38	9,5	.44	11,1	.05	1,3
.38	9,5	4.00	101,6	8916	8917	CW 500 PE	.50	12,7	.50	12,7	.06	1,6
.50	12,7	4.50	114,3	8920	8921	CW 625 PE*	.63	15,9	.63	15,9	.06	1,6
		5.00	127,0	8924	8925	CW 750 PE	.75	19,1	.75	19,1	.07	1,7
1.00	25,4	7.00	177,8	8928	8929	CW 1000 PE	1.00	25,4	1.00	25,4	.08	2,0

Standard colors UV black or natural.

* Parts are not UR recognized.

Heavy Duty

BUNDLE RANGE				PART NO.		DESCRIPTION	PART DIMENSIONS					
Minimum Diameter		Maximum Diameter		Black	Color Coded		A Outside Dia.		B Pitch		C Thickness	
in.	mm.	in.	mm.			in.	mm.	in.	mm.	in.	mm.	
.75	19,1	1.50	38,1	8964	8965 Red	CWG 99 PE	.93	23,6	.95	24,1	.12	3,0
1.00	25,4	2.00	50,8	8966	8967 Blue	CWG 126 PE	1.12	28,4	1.25	31,8	.13	3,3
1.25	31,8	2.50	63,5	8968	8969 Green	CWG 153 PE	1.37	34,8	1.35	34,3	.14	3,5
1.50	38,1	3.00	76,2	8970	8971 Yellow	CWG 181 PE	1.62	41,1	1.50	38,1	.15	3,9
2.00	50,8	3.50	88,9	8972	8973 Orange	CWG 234 PE	2.09	53,1	1.60	40,6	.17	4,3

*Standard color black or color coded.

- Designed to shield hydraulic, pneumatic, and high pressure hoses; cables and cable bundles.
- Available in a **variety of sizes** that fit cable, cable bundles and hoses from .75” (19,1 mm) to 3.50” (88,9 mm) in diameter.
- **Smooth finish interior wall.**
- May be **color coded** (see tabular chart).
- Packaged as one continuous piece, not spooled.
- May be **cut to desired length**, please consult Heyco.

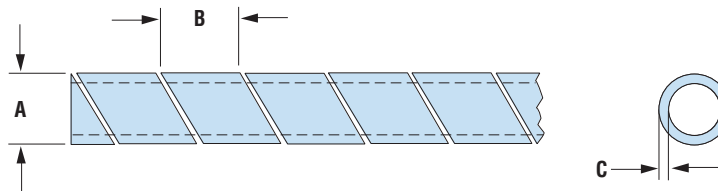

Quick Specs

Material	Polyethylene (Standard), High Density Polyethylene (Heavy Duty)
Certifications	UL Recognized under the Component Program of Underwriters' Laboratories File E173954. (Standard Only)
Temperature Range	-76°F (-60°C) to 190°F (88°C) UL rated temp not to exceed 122°F (50°C) (Standard) 0°F (-18°C) to 165°F (74°C) (Heavy Duty)

“Stay Connected” with



HEYware

a PennEngineering® Company



Heyco® Hose and Cable Wrap-Nylon

BUNDLE RANGE				PART NO.		DESCRIPTION	PART DIMENSIONS					
Minimum Diameter		Maximum Diameter		UV Black	Natural		A Outside Diameter		B Pitch		C Thickness	
in.	mm.	in.	mm.			in.	mm.	in.	mm.	in.	mm.	
.13	3,2	1.50	38,1	8936	8937	CW 187 N*	.19	4,8	.25	6,3	.02	0,5
.19	4,8	2.00	50,8	8940	8941	CW 250 N	.25	6,3	.38	9,5	.03	0,6
.31	7,9	3.00	76,2	8944	8945	CW 375 N	.38	9,5	.44	11,1	.04	0,9
.38	9,5	4.00	101,6	8948	8949	CW 500 N	.50	12,7	.50	12,7		
.50	12,7	4.50	114,3	8952	8953	CW 625 N*	.63	15,9	.63	15,9	.03	0,8
		5.00	127,0	8956	8957	CW 750 N	.75	19,0	.75	19,1		
1.00	25,4	7.00	177,8	8960	8961	CW 1000 N	1.00	25,4	1.00	25,4		

Standard colors UV black or natural.

* Parts are not UL recognized.

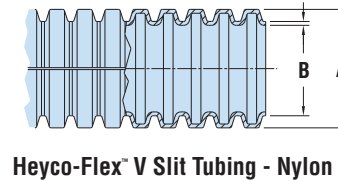
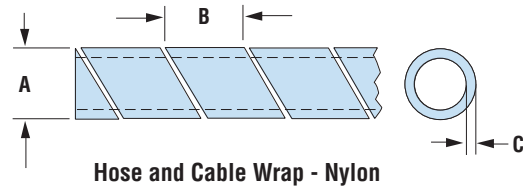

- Easy to use: Just twist on wire!
- Allows breakouts of single/multiple wires and re-routing of replacement wires.
- Absorbs vibration, insulates cables, and resists abrasion.
- Multiple sizes bundle and protect cables, wires, tubing, and hoses from .13” (3,2 mm) to 7.00” (177,8 mm) diameters.
- Available in UV black or natural nylon color.
- Conforms to: ASTM D 4066, Group 2; Fed Spec LP410A
- For hose and cable **clamps**, see pages 7-36 through 7-43.

Heyco-Flex™ V Nylon Slit Tubing

NOMINAL DIAMETER	PART NO.	DESCRIPTION	PART DIMENSIONS						ROLL LENGTH
			A Outside Diameter		B Inside Diameter		Wall Thickness Range		
in.	Black		in.	mm.	in.	mm.	in.	mm.	ft.
1/8	1634A	HF5 1/8	.26	6,6	.17	4,3	.01-.02	0,2-0,5	100
1/4	1635A	HF5 1/4	.39	9,9	.29	7,3			
11/32	1636A	HF5 11/32	.51	13,0	.35	8,8			
3/8	1637A	HF5 3/8	.53	13,5	.42	10,5			
7/16	1638A	HF5 7/16	.63	15,9	.44	11,2			
1/2	1639A	HF5 1/2	.64	16,2	.53	13,3			
5/8	1641A	HF5 5/8	.81	20,5	.66	16,8			
3/4	1642A	HF5 3/4	.93	23,6	.79	20,1			
1	1643A	HF5 1	1.12	28,5	.92	23,3			
1-1/16	1644A	HF5 1-1/16	1.22	30,9	1.01	25,6			
1-1/4	1646A	HF5 1-1/4	1.49	37,9	1.28	32,6			
1-1/2	1649A	HF5 1-1/2	1.73	43,9	1.47	37,2			

Standard color black.

CW	
Material	Nylon
Certifications	Recognized under the Component Program of Underwriters' Laboratories File E173954
Temperature Range	-40°F (-40°C) to 250°F (121°C) – UL rated temp not to exceed 149°F (65°C)
HF5	
Material	Polyamide 6 Nylon
Flammability Rating	94HB
Temperature Range	-40°F (-40°C) to 239°F (115°C) Continuous -40°F (-40°C) to 374°F (190°C) Intermittent



- **Slit design allows side entry** and encirclement of preassembled harnesses and capillary tubes.
- Unique slit design allows for wire breakouts.
- Heyco-Flex V is lightweight and flexible, yet durable enough to meet your wire management requirements.
- Multiple sizes 1/8” to 1-1/2”.
- All nylon construction resists salt water, weak acids, gasoline, alcohol, oil, grease, and common solvents.
- Quick installation; cuts with utility knife, PVC cutter or Heyco cutting tool #8340. See page 2-8.

Quick Specs



HEYClip™ Snap Rivets

- Designed for **fast and easy installation with no tools** - just fingertip pressure required.
- Simply place rivet into the hole and press down on the head to fasten; legs expand to securely fasten components.
- To release, simply pull up on rivet head section.
- Round head provides a clean, finished look.
- Part Description Key: PR X-Y where X = Mounting Hole Diameter (inches) and Y = minimum Panel Thickness (inches).
- Standard Material: Nylon 6. Nylon 6/6 UL 94V-0 available by special order, consult Heyco.
- Standard Pack - 1,000/bag.

WILL FIT THESE PANELS				PART NO.			DESCRIPTION	PART DIMENSIONS						EXTRACTION FORCE			
MOUNTING HOLE DIA.		ASSEMBLED PANEL THICKNESS		Black	White	V-0 Black *		A Length		B Head Height		C Head Diameter		N	Style		
in.	mm.	Min. in.	Max. mm.					in.	mm.	in.	mm.	in.	mm.			in.	mm.
PR Series																	
.083	2,1	.02	0,5	.05	1,3	9296	9297	9296F	PR 083-024	.10	2,5						
		.05	1,3	.08	2,0	9300	9301	9300F	PR 083-051	.13	3,3						
		.08	2,0	.11	2,8	9302	9303	9302F	PR 083-083	.16	4,1	.05	1,3	.17	4,3	29	2
		.11	2,8	.14	3,6	9304	9305	9304F	PR 083-114	.19	4,8						
		.15	3,8	.17	4,3	9306	9307	9306F	PR 083-146	.22	5,6						
		.17	4,3	.20	5,1	9308	9309	9308F	PR 083-173	.25	6,4						
.102	2,6	.04	1,0	.08	2,0	9020	9021	9020F	PR 102-039	.13	3,3						
		.08	2,0	.12	3,0	9022	9023	9022F	PR 102-082	.17	4,3						
		.11	2,8	.14	3,6	9024	9025	9024F	PR 102-106	.19	4,8	.06	1,5	.20	5,1	49	2
		.13	3,3	.17	4,3	9026	9027	9026F	PR 102-134	.22	5,6						
		.17	4,3	.21	5,3	9310	9311	9310F	PR 102-169	.25	6,4						
		.20	5,1	.24	6,1	9312	9313	9312F	PR 102-201	.28	7,1						
.106	2,7	.13	3,3	.17	4,3	19000	19001	19000F	PR 106-133	.23	5,8	.06	1,5	.20	5,1	49	NEW!
.118	3,0	.14	3,5	.18	4,6	19002	19003	19002F	PR 118-137	.30	7,6	.07	1,8	.24	6,1	122	NEW!
		.14	3,5	.22	5,6	19004	19005	19004F	PR 118-138	.31	7,9	.06	1,5	.24	6,1		NEW!
.122	3,1	.04	1,0	.08	2,0	9028	9029	9028F	PR 122-039	.14	3,5						
		.08	2,0	.12	3,0	9030	9031	9030F	PR 122-079	.18	4,6						
		.12	3,0	.16	4,1	9032	9033	9032F	PR 122-118	.22	5,6						
		.16	4,1	.19	4,8	9034	9035	9034F	PR 122-157	.26	6,6						
		.20	5,1	.24	6,1	9036	9037	9036F	PR 122-197	.30	7,6						
		.22	5,5	.26	6,6	9038	9039	9038F	PR 122-217	.32	8,1	.06	1,5	.25	6,4	78	2
		.26	6,6	.30	7,6	9040	9041	9040F	PR 122-256	.35	8,9						
		.30	7,6	.34	8,6	9042	9043	9042F	PR 122-295	.39	9,9						
		.45	11,4	.51	13,0	9314	9315	9314F	PR 122-453	.57	14,5						
		.81	20,6	.85	21,6	9316	9317	9316F	PR 122-807	.91	23,1						
.142	3,6	.05	1,3	.08	2,0	9044	9045	9044F	PR 142-047	.14	3,5						
		.08	2,0	.12	3,0	9046	9047	9046F	PR 142-083	.18	4,6						
		.11	2,8	.14	3,6	9048	9049	9048F	PR 142-106	.20	5,1	.06	1,5	.25	6,4	118	1
		.12	3,0	.16	4,1	9050	9051	9050F	PR 142-118	.22	5,6						
		.15	3,8	.18	4,6	9052	9053	9052F	PR 142-146	.24	6,1						
		.18	4,6	.22	5,6	9054	9055	9054F	PR 142-177	.28	7,1						
.157	4,0	.09	2,3	.11	2,8	19006	19007	19006F	PR 157-086	.22	5,6	.08	2,0	.31	7,9	196	1
		.21	5,3	.24	6,1	19008	19009	19008F	PR 157-212	.31	7,9	.07	1,8	.32	8,1		NEW!
		.41	10,4	.45	11,4	19010	19011	19010F	PR 157-413	.53	13,5	.08	2,0	.31	7,9	196	2
.161	4,1	.10	2,5	.14	3,5	9058	9059	9058F	PR 161-098	.20	5,1						
		.14	3,5	.18	4,6	9060	9061	9060F	PR 161-138	.24	6,1						
		.18	4,6	.22	5,6	9062	9063	9062F	PR 161-177	.28	7,1						
		.22	5,6	.26	6,6	9064	9065	9064F	PR 161-217	.32	8,1	.07	1,8	.32	8,1	196	1
		.26	6,6	.30	7,6	9066	9067	9066F	PR 161-256	.35	8,9						
		.30	7,6	.34	8,6	9068	9069	9068F	PR 161-295	.39	9,9						
		.35	8,9	.41	10,4	9318	9319	9318F	PR 161-354	.47	11,9						
		.49	12,4	.55	14,0	9320	9321	9320F	PR 161-492	.61	15,5						

Available in Small Packs **NEW**

PART NO.		DESCRIPTION	QTY
Black	White		
9028-P	9029-P	PR 122-039 100PK	100
9030-P	9031-P	PR 122-079 100PK	
9032-P	9033-P	PR 122-118 100PK	
9034-P	9035-P	PR 122-157 100PK	
9036-P	9037-P	PR 122-197 100PK	
9038-P	9039-P	PR 122-217 100PK	
9058-P	9059-P	PR 161-098 50PK	50
9060-P	9061-P	PR 161-138 50PK	
9062-P	9063-P	PR 161-177 50PK	
9064-P	9065-P	PR 161-217 50PK	
9066-P	9067-P	PR 161-256 50PK	
9068-P	9069-P	PR 161-295 50PK	
9074-P	9075-P	PR 201-138 50PK	20
9076-P	9077-P	PR 201-177 50PK	
9078-P	9079-P	PR 201-217 50PK	
9080-P	9081-P	PR 201-256 50PK	
9082-P	9083-P	PR 201-295 50PK	
9084-P	9085-P	PR 240-098 20PK	
9324-P	9325-P	PR 240-138 20PK	

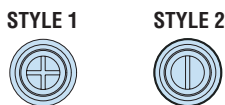
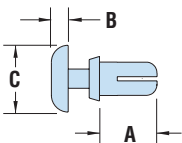

Quick Specs

Standard colors black and white.
*Black nylon 6/6 UL 94V-0.

Material	Nylon 6 UL V-2
Flammability Rating	94V-2
Temperature Range	-40°F (-40°C) to 239°F (115°C)

“Stay Connected” with



HEYware

a PennEngineering® Company



HEYClip™ Snap Rivets – continued

WILL FIT THESE PANELS				PART NO.			DESCRIPTION	PART DIMENSIONS						EXTRACTION FORCE		
MOUNTING HOLE DIA.	ASSEMBLED PANEL THICKNESS		Black	White	V-0 Black *	A Length		B Head Height		C Head Diameter		N	Style			
	in.	mm.					Min.	Max.	in.	mm.	in.			mm.	in.	mm.
PR Series																
.201	5,1	.06	1,5	.10	2,5	9070	9071	9070F	PR 201-059	.18	4,6					1
		.10	2,5	.14	3,5	9072	9073	9072F	PR 201-098	.22	5,6					
		.14	3,5	.18	4,6	9074	9075	9074F	PR 201-138	.26	6,6					
		.18	4,6	.22	5,6	9076	9077	9076F	PR 201-177	.30	7,6	.09	2,3	.35	8,9	
		.22	5,6	.26	6,6	9078	9079	9078F	PR 201-217	.34	8,6					
		.26	6,6	.30	7,6	9080	9081	9080F	PR 201-256	.37	9,4					
		.30	7,6	.34	8,6	9082	9083	9082F	PR 201-295	.41	10,4					
.232	5,9	.12	3,0	.16	4,1	9322	9323	9322F	PR 232-118	.25	6,4	.11	2,8	.47	11,9	294
.240	6,1	.10	2,5	.16	4,1	9084	9085	9084F	PR 240-098	.24	6,1	.10	2,5			
		.14	3,5	.22	5,6	9324	9325	9324F	PR 240-138	.32	8,1	.12	3,0			

Standard colors black and white.

*Black nylon 6/6 UL 94V-0.

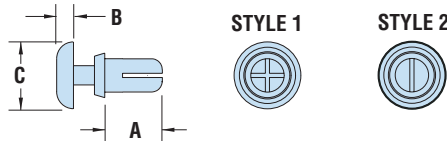

- Designed for **fast and easy installation with no tools** - just fingertip pressure required.
- Simply place rivet into the hole and press down on the head to fasten; legs expand to securely fasten components.
- To release, simply pull up on rivet head section.
- Round head provides a clean, finished look.
- Part Description Key: PR X-Y where X = Mounting Hole Diameter (inches) and Y = minimum Panel Thickness (inches).
- Standard Material: Nylon 6. Nylon 6/6 UL 94V-0 available by special order, consult Heyco.
- Standard Pack - 1,000/bag.
- See Quick Specs on opposite page.

HEYClip™ Heat Resistant Snap Rivets

WILL FIT THESE PANELS				PART NO.			DESCRIPTION	PART DIMENSIONS						EXTRACTION FORCE	
MOUNTING HOLE DIA.	ASSEMBLED PANEL THICKNESS		Tan Nylon 4/6 UL94V-2	Tan	Nylon 4/6 UL94V-2	A Length		B Head Height		C Head Diameter		N	Style		
	in.	mm.					Min.	Max.	in.	mm.	in.			mm.	in.
PR Tan Series															
.122	3,1	.04	1,0	.08	2,0	9028H	PR 122-039 HR Tan	.14	3,5					78	2
		.08	2,0	.12	3,0	9030H	PR 122-079 HR Tan	.18	4,5						
		.12	3,0	.16	4,0	9032H	PR 122-118 HR Tan	.22	5,6	.06	1,6	.25	6,4		
		.16	4,0	.19	5,0	9034H	PR 122-157 HR Tan	.26	6,5						
		.22	5,5	.26	6,5	9038H	PR 122-217 HR Tan	.32	8,0						
.142	3,6	.05	1,2	.08	2,1	9044H	PR 142-047 HR Tan	.14	3,5					118	1
		.08	2,1	.12	3,0	9046H	PR 142-083 HR Tan	.18	4,5						
		.11	2,7	.14	3,6	9048H	PR 142-106 HR Tan	.20	5,0	.06	1,6	.25	6,4		
		.12	3,0	.16	4,0	9050H	PR 142-118 HR Tan	.22	5,6						
.161	4,1	.10	2,5	.14	3,5	9058H	PR 161-098 HR Tan	.20	5,0					196	1
		.14	3,5	.18	4,5	9060H	PR 161-138 HR Tan	.24	6,0						
		.18	4,5	.22	5,5	9062H	PR 161-177 HR Tan	.28	7,0	.07	1,8	.32	8,0		
		.22	5,5	.26	6,5	9064H	PR 161-217 HR Tan	.32	8,0						
		.30	7,5	.34	8,5	9068H	PR 161-295 HR Tan	.39	10,0						

Standard color tan (beige).



- Molded from Nylon 4/6 94V-2 - **heat resistant to 266°F (130°C)**.
- Automotive **tan** (beige) color.
- Designed for fast and easy installation with no tools - just fingertip pressure required.
- Simply place rivet into the hole and press down on the head to fasten; legs expand to securely fasten components.
- Part Description Key: PR X-Y where X = Mounting Hole Diameter (inches) and Y = minimum Panel Thickness (inches).
- Standard Pack - 1,000/bag.

Material: Nylon 4/6
 Flammability Rating: 94V-2
 Temperature Range: -4°F (-18°C) to 266°F (130°C)

Quick Specs



HEYClip™ Countersunk Type H Rivets

- Flat, **chamfered rivet head** for **easier disassembly** when required.
- Accommodate countersunk hole specification DIN ISO 7721.
- The "H" type rivet is designed with a flat head for fast and easy installation, without any tools.
- Simply place rivet into the hole and press down on the head to fasten.
- Part Description Key: PRH X-Y where X = Mounting Hole Diameter (inches) and Y = minimum Panel Thickness (inches).
- Standard Material: Nylon 6. Nylon 6/6 UL 94V-0 available by special order, consult Heyco.
- Standard Pack - 1,000/bag.

WILL FIT THESE PANELS						PART NO.			DESCRIPTION	PART DIMENSIONS						EXTRACTION FORCE	
MOUNTING HOLE DIA.		ASSEMBLED PANEL THICKNESS				Black	White	V-0 Black *		A Length		B Head Height		C Head Diameter		N	Style
in.	mm.	Min.	Max.	in.	mm.					in.	mm.	in.	mm.	in.	mm.		
PRH Series																	
.102	2,6	.22	5,5	.26	6,5	9118	9119	9118F	PRH 102-217	.33	8,5	.03	0,7	.18	4,6	49	1
.122	3,1	.04	1,0	.08	2,0	9156	9157	9156F	PRH 122-039	.14	3,5	.04	1,0	.25	6,4	78	1
		.08	2,0	.12	3,0	9158	9159	9158F	PRH 122-079	.18	4,5						
		.12	3,0	.16	4,0	9160	9161	9160F	PRH 122-118	.22	5,5						
		.16	4,0	.19	5,0	9162	9163	9162F	PRH 122-157	.26	6,5						
		.20	5,0	.24	6,0	9164	9165	9164F	PRH 122-197	.31	7,5						
		.22	5,5	.26	6,5	9166	9167	9166F	PRH 122-217	.32	8,0						
		.26	6,5	.30	7,5	9168	9169	9168F	PRH 122-256	.35	9,0						
.30	7,5	.34	8,5	9170	9171	9170F	PRH 122-295	.39	10,0								
.142	3,6	.04	1,0	.08	2,0	9172	9173	9172F	PRH 142-039	.14	3,5	.04	1,0	.25	6,4	118	2
		.08	2,0	.12	3,0	9174	9175	9174F	PRH 142-079	.19	4,5						
		.12	3,0	.16	4,0	9176	9177	9176F	PRH 142-118	.22	5,5						
		.14	3,5	.18	4,5	9178	9179	9178F	PRH 142-138	.24	6,0						
		.18	4,5	.22	5,5	9180	9181	9180F	PRH 142-177	.28	7,0						
		.22	5,5	.26	6,5	9182	9183	-	PRH 142-217	.32	8,0						

Standard colors black and white.
*Black nylon 6/6 UL 94V-0.

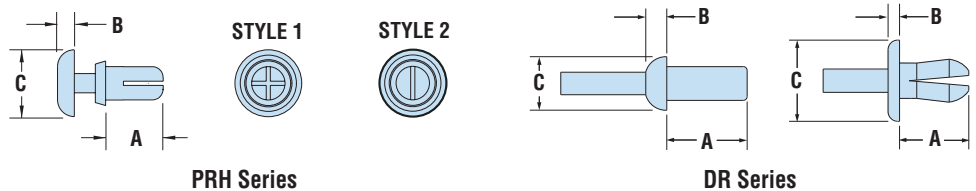

HEYClip™ Drive Rivets

- Install by placing rivet into hole and pushing the drive pin into the rivet to expand legs and lock in place.
- No tools required.
- Part Description Key: DR X-Y where X = Mounting Hole Diameter (inches) and Y = minimum Panel Thickness (inches).
- Standard Pack - 1,000/bag.

WILL FIT THESE PANELS						PART NO.		DESCRIPTION	PART DIMENSIONS						
MOUNTING HOLE DIA.		ASSEMBLED PANEL THICKNESS				Black	Natural		A Length		B Head Height		C Head Diameter		
in.	mm.	Min.	Max.	in.	mm.				in.	mm.	in.	mm.	in.	mm.	
.161	4,1	.16	4,0	.26	6,5	9331	9332	DR 161-157	.32	8,1	.06	1,5	.30	7,5	NEW!
		.04	1,0	.38	9,5	9184	9185	DR 189-039	.42	10,7	.06	1,5	.28	7,1	
.187	4,8	.16	4,0	.28	7,1	9186	9187	DR 189-158	.38	9,7	.06	1,5	.43	10,9	
		.201	5,1	.06	1,5	.28	7,0	9336	-	DR 201-059	.36	9,1	.07	1,8	.33
.218	5,5	.09	2,4	.16	4,0	9188	9189	DR 217-094	.45	11,4	.08	2,0	.37	9,4	
.236	6,0	.12	3,0	.28	7,0	9337	-	DR 236-118	.39	10,0	.08	2,0	.43	10,9	NEW!
		.06	1,5	.25	6,4	9190	9191	DR 252-059	.37	9,3	.19	4,7	.44	11,1	
.250	6,4	.12	3,0	.28	7,0	9341	-	DR 252-118	.49	12,5	.08	2,0	.47	11,9	NEW!
		.28	7,1	.50	12,7	9192	9193	DR 252-280	.62	15,8					

Standard colors black and natural.
*Standard color white.

Material	PRH - Nylon 6	DR - Nylon 6/6
Flammability Rating	94V-2	
Temperature Range	-40°F (-40°C) to 185°F (85°C)	

Quick Specs

“Stay Connected” with



HEYware

a PennEngineering® Company



HEYClip™ Releasable Type T Rivets

WILL FIT THESE PANELS					PART NO.		DESCRIPTION	PART DIMENSIONS						STYLE	
MOUNTING HOLE DIA.		ASSEMBLED PANEL THICKNESS			Black	White		A		B		C			
in.	mm.	Min.	Max.	in.				mm.	Length	mm.	Head Height	mm.	Head Diameter		mm.
KR Series															
.122	3,1	.04	1,0	.08	2,0	9088	9089	KR 122-039	.14	3,5					1
		.08	2,0	.12	3,0	9090	9091	KR 122-079	.18	4,5					
		.12	3,0	.16	4,0	9092	9093	KR 122-118	.22	5,5	.32	8,0	.39	10,0	
		.16	4,0	.20	5,0	9094	9095	KR 122-157	.26	6,5					
		.20	5,0	.24	6,0	9194	9195	KR 122-197	.30	7,5					
		.22	5,5	.26	6,5	9096	9097	KR 122-217	.32	8,0					
.142	3,6	.04	1,0	.08	2,0	9098	9099	KR 142-039	.14	3,5					2
		.08	2,0	.12	3,0	9100	9101	KR 142-079	.18	4,5					
		.12	3,0	.16	4,0	9102	9103	KR 142-118	.22	5,5	.32	8,0	.39	10,0	
		.14	3,5	.18	4,5	9104	9105	KR 142-137	.24	6,0					
		.18	4,5	.22	5,5	9106	9107	KR 142-177	.28	7,0					
		.22	5,5	.26	6,5	9196	9197	KR 142-217	.32	8,0					
.161	4,1	.10	2,5	.14	3,5	9108	9109	KR 161-098	.20	5,0					2
		.14	3,5	.18	4,5	9110	9111	KR 161-137	.24	6,0					
		.18	4,5	.22	5,5	9112	9113	KR 161-177	.28	7,0	.32	8,0	.47	12,0	
		.22	5,5	.26	6,5	9114	9115	KR 161-217	.32	8,0					
		.26	6,5	.30	7,5	9198	9199	KR 161-256	.35	9,0					
		.30	7,5	.34	8,5	9116	9117	KR 161-295	.39	10,0					

Standard colors black and white.

- The “T” style rivet is designed with a **large finger grip**, knob-shaped head for optimal installation and removal by simply pushing or pulling the rivet from the hole.
- Can be used multiple times.
- Part Description Key: KR X-Y where X = Mounting Hole Diameter (inches) and Y = minimum Panel Thickness (inches).
- Standard Material: Nylon 6. Nylon 6/6 UL 94V-0 available by special order, consult Heyco.
- Standard Pack - 1,000/bag.

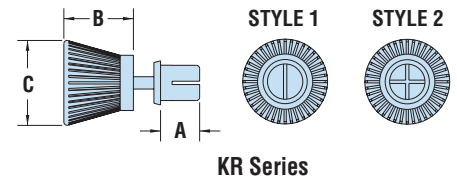

HEYClip™ Type P Snap Rivets

Polysulfone High Temperature Snap Rivets

WILL FIT THESE PANELS					PART NO.		DESCRIPTION	PART DIMENSIONS						STYLE
MOUNTING HOLE DIA.		ASSEMBLED PANEL THICKNESS			Black	A		B		C				
in.	mm.	Min.	Max.	in.		mm.		Length	mm.	Head Height	mm.	Head Diameter	mm.	
PRP Series														
.122	3,1	.078	2,0	.118	3,0	9349	PRP 122-079	.18	4,5	.06	1,6	.25	6,4	1
		.118	3,0	.157	4,0	9350	PRP 122-118	.22	5,6					
.161	4,1	.157	4,0	.197	5,0	9351	PRP 122-157	.26	6,5	.04	1,0	.28	7,0	2

Standard color black.

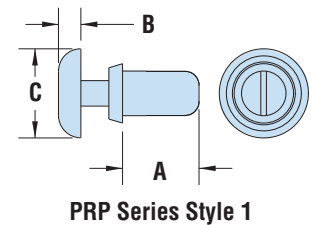

PRP Series Style 1

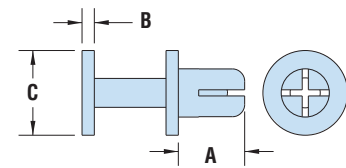

PRP Series Style 2

	KR	PRP
Material	Nylon 6	Polysulfone (PSU)
Flammability Rating	94V-2	94-HB
Temperature Range	-40°F (-40°C) to 239°F (115°C)	32°F (0°C) to 302°F (150°C)



HEYClip™ Shorty Snap Rivets

Two Piece Snap Together Rivets

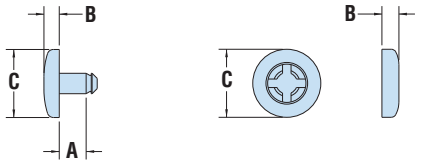

SSRP Series

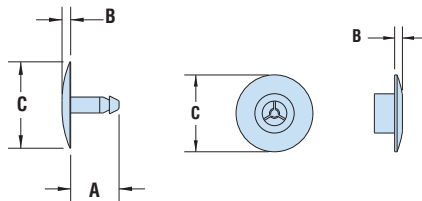

SSRPT Series

WILL FIT THESE PANELS				PART NO.	DESCRIPTION	PART DIMENSIONS						STYLE
MOUNTING HOLE DIA.	ASSEMBLED PANEL THICKNESS		Natural			A Length		B Head Height		C Head Diameter		
	in.	mm.	in.	mm.			in.	mm.	in.	mm.	in.	mm.
SSRP Series - Pin fits a .125" (3,2 mm) diameter hole												
.125	3,2	.030	0,8	4064	SSRP-030	.06	1,6	.09	2,3	.40	10,2	1
		.062	1,6	4065	SSRP-062	.10	2,4					
		.100	2,5	4069	SSRP-100	.13	3,4					
		.125	3,2	4071	SSRP-125	.16	4,0					
		.187	4,8	4073	SSRP-187	.22	5,6					
.250	6,4	4075	SSRP-250	.28	7,2							
FEMALE CAP for the above parts				4077	SSRC	n/a		.10	2,5	.40	10,2	2
SSRPT Series - Cap fits a .320" (8,1 mm) diameter hole												
.320	8,1	.170 - .190	4,3 - 4,8	4715	SSRPT-190	.21	5,3	.06	1,6	.40	10,2	3
		.220 - .240	5,6 - 6,1	4716	SSRPT-220	.26	6,6					
		.320 - .340	8,1 - 8,6	4717	SSRPT-340	.35	8,9					
		.320 - .600	8,1 - 15,2	4718	SSRPT-600	.63	16,0					
		ADJUSTABLE		4714	SSRPT-ADJ	1.50	38,1					
FEMALE CAP for the above parts				4719	SSRCT	n/a		.06	1,6	.63	15,9	5

Standard color natural.



- Complete assembly requires two parts. They snap into each other, thus holding flat panels together.

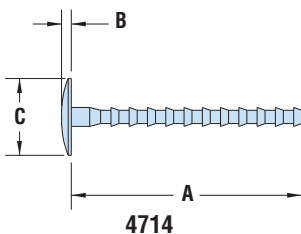

4714

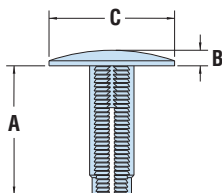

RR Series

HEYClip™ Ratchet Rivets

WILL FIT THESE PANELS				PART NO.	DESCRIPTION	PART DIMENSIONS							
MOUNTING HOLE DIA.	ASSEMBLED PANEL THICKNESS		Natural			A Length		B Head Height		C Head Diameter			
	in.	mm.	Min.	Max.			in.	mm.	in.	mm.	in.	mm.	
RR Series													
.281	7,1	.235	6,0	.297	7,5	12480	RR 0297-41	.23	5,7	.06	1,6	.41	10,3
		.345	8,8	.500	12,7	12481	RR 0500-41	.34	8,7				
		.500	12,7	.813	20,7	12482	RR 0813-41	.49	12,4				
		.780	19,8	1.375	34,9	12483	RR 1375-41	.77	19,5				
		.235	6,0	.298	7,6	12484	RR 0298-75	.23	5,7				
		.345	8,8	.500	12,7	12485	RR 0500-75	.34	8,7	.09	2,4	.75	19,1
		.500	12,7	.812	20,6	12486	RR 0812-75	.49	12,4				
		.780	19,8	1.375	34,9	12487	RR 1375-75	.77	19,5				

Standard color natural.

Material Nylon 6/6
 Flammability Rating 94 V-2
 Temperature Range 32°F (0°C) to 185°F (85°C)



HEYClip™ Unscrewing Snap Rivets

WILL FIT THESE PANELS						PART NO.	DESCRIPTION	PART DIMENSIONS						STYLE
MOUNTING HOLE DIA.		ASSEMBLED PANEL THICKNESS						A Length		B Head Height		C Head Diameter		
in.	mm.	Min. in.	Max. in.	Min. mm.	Max. mm.			in.	mm.	in.	mm.	in.	mm.	
HUSR Series														
.197	5,0	.059	1,5	.236	6,0	4330	HUSR 197-158	.43	11,0	.15	3,9	.47	12,0	1
.236	6,0	.059	1,5	.236	6,0	4331	HUSR 236-059	.43	11,0	.15	3,9	.63	16,0	
.315	8,0	.118	3,0	.394	10,0	4332	HUSR 315-118	.55	14,0	.16	4,0	.79	20,0	
		.276	7,0	.315	8,0	4333	HUSR 315-276	.80	20,3	.14	3,6	.79	20,0	3

Standard color black.

HEYClip™ Tough Rivets

WILL FIT THESE PANELS								PART NO.	DESCRIPTION	PART DIMENSIONS					
MOUNTING HOLE DIAMETER		ASSEMBLED PANEL THICKNESS				A Length Below Panel				B Head Height		C Head Diameter			
Minimum in.	Maximum mm.	Minimum in.	Maximum in.	Minimum mm.	Maximum mm.	in.	mm.			in.	mm.	in.	mm.		
Mini - MTR Series															
.122	3,1	.128	3,3	.155	3,9	.180	4,6	12475	MTR 180-125	.37	9,4	.05	1,3	.22	5,5
.144	3,7	.154	3,9	.265	6,7	.290	7,4	12477	MTR 290-150	.47	11,9	.05	1,3	.30	7,6
Standard - TR Series															
.193	4,9	.205	5,2	.059	1,5	.181	4,6	12466	TR 181-199	.45	11,3	.08	2,1	.28	7,2
.250	6,4	.276	7,0	.098	2,5	.315	8,0	12468	TR 315-263	.90	22,8	.11	2,8		
.315	8,0	.325	8,3	.118	3,0	.315	8,0	12469	TR 315-320	.83	21,1	.09	2,3	.59	15,0

Standard color black.

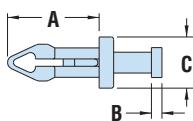

MTR Series

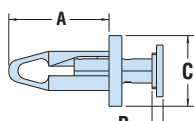

TR Series

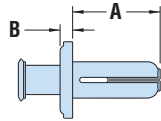

HRR Series

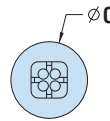

Heyco® Removable Rivets

ALL NEW PRODUCTS

WILL FIT THESE PANELS				PART NO.	DESCRIPTION	PART DIMENSION					
Mounting Hole Diameter		Assembled Panel Thickness				A Length Below Panel		B Head Height		C Head Diameter	
in.	mm.	in.	mm.			in.	mm.	in.	mm.	in.	mm.
.188	4,8	.062	1,6	12220	HRR 062-188	.50	12,7	.07	1,8	.38	9,5
		.125	3,2	12221	HRR 125-188						
		.062	1,6	12222*	HRR 062-250						
.250	6,4	.125	3,2	12223	HRR 125-250	.50	12,7	.07	1,8	.44	11,1
		.187	4,7	12224	HRR 187-250						

Standard color natural.

*Will also fit .210" x .218" square hole (for Darling Shelves).

	HUSR & HRR	MTR	TR
Material	Nylon 6/6	Heat stabilized Nylon 6	Impact Modified Nylon 6/6
Flammability Rating	94V-2	94 V-2	94HB
Temperature Range	32°F (0°C) to 185°F (85°C)	32°F (0°C) to 230°F (110°C)	-40°F (-40°C) to 185°F (85°C)



- Phillips head screw driver required for removal.

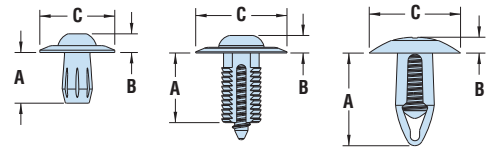

Style 1

Style 2

Style 3



- Molded from impact modified nylon for vibration resistance.
- One-piece design requires no tools for installation.
- Provide solid, vibration-resistant connections by means of front mount, blind side fixing.
- Provide neat and smooth finishes for fastening applications.
- Removable by pulling the pin out of the grommet; reusable.



- Two-piece rivet can be removed by retracting the pin then the body.
- Slot in line with pin for pin removal with small screw driver, fingernail or other sharp edge underneath the head of the pin.



HEYClip™ Blunt Rivets

- Part Description Key: PR XXX-YYY where XXX = Mounting Hole Diameter (inches) and YYY = minimum Panel Thickness (inches).

- Pre-driven

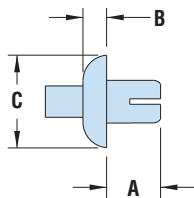

Mounting Hole Dia.	WILL FIT THESE PANELS Assembled Panel Thickness						PART NO.		DESCRIPTION	PART DIMENSIONS					
	Minimum		Maximum		Black	White	A Length			B Head Height		C Head Diameter			
	in.	mm.	in.	mm.			in.	mm.		in.	mm.	in.	mm.		
.122	3,1	.078	2,0	.118	3,0	13350	13351	BR 122-078	.18	4,5	.08	2,0	.23	5,8	
		.118	3,0	.157	4,0	13352	13353	BR 122-118	.22	5,5					
.161	4,1	.098	2,5	.138	3,5	9141	9142	BR 161-098	.20	5,0	.09	2,2	.31	8,0	
		.138	3,5	.177	4,5	13356	13357	BR 161-138	.24	6,0					
.201	5,1	.078	2,0	.118	3,0	13360	13361	BR 201-078	.20	5,0	.11	2,8	.37	9,5	
		.118	3,0	.157	4,0	13362	13363	BR 201-118	.24	6,0					
		.157	4,0	.197	5,0	13364	13365	BR 201-157	.28	7,0					
		.197	5,0	.236	6,0	13366	13367	BR 201-197	.32	8,0					
		.236	6,0	.276	7,0	13368	13369	BR 201-236	.35	9,0					
		.276	7,0	.315	8,0	13370	13371	BR 201-276	.39	10,0					

Standard colors black and white.



Heyco® Expansion Rivets

- One-piece, all plastic expansion rivet.
- Designed to securely fasten a wide variety of materials in a range of applications.
- Inserts quickly from either side of assembly.
- Use with standard rivet setting tool - pull the pin through the body and panels are drawn together.
- Pin breaks off even with head and leaves an attractive, finished appearance.
- Effective for soft materials such as rubber, padded fabrics, etc.

Mounting Hole Dia.	WILL FIT THESE PANELS Assembled Panel Thickness						PART NO.	DESCRIPTION	PART DIMENSIONS					
	Minimum		Maximum		Black	A Length			B Head Height		C Head Diameter			
	in.	mm.	in.	mm.		in.			mm.	in.	mm.	in.	mm.	
EXR Style 1														
.157	4,0	.059	1,5	.177	4,5	12230	EXR 177-157	.73	18,5	.10	2,5	.31	8,0	
		.118	3,0	.157	4,0	12231	EXR 157-197	.65	16,5					
.197	5,0	.118	3,0	.236	6,0	12232	EXR 236-197	.79	20,0	.07	1,8	.47	12,0	
		.236	6,0	.394	10,0	12233	EXR 394-197	.98	25,0					
.236	6,0	.157	4,0	.335	8,5	12235	EXR 335-236	1.10	28,0	.10	2,5	.51	13,0	
.240	6,1	.157	4,0	.311	7,9	12237	EXR 311-240	1.14	29,0	.10	2,5	.67	16,9	
.248	6,3	.295	7,5	.453	11,5	12238	EXR 453-248	1.26	31,9					
EXR Style 2														
.130	3,3	.039	1,0	.138	3,5	12650	EXR 138-130	.25	6,4	.06	1,4	.25	6,4	
		.138	3,5	.256	6,5	12651	EXR 256-130	.38	9,6					
		.256	6,5	.374	9,5	12652	EXR 374-130	.50	12,7					
.161	4,1	.039	1,0	.138	3,5	12653	EXR 138-161	.25	6,4	.07	1,8	.32	8,0	
		.138	3,5	.236	6,0	12654	EXR 236-161	.38	9,6					
		.236	6,0	.354	9,0	12655	EXR 354-161	.50	12,7					
.193	4,9	.059	1,5	.177	4,5	12656	EXR 177-193	.31	8,0	.08	2,0	.38	9,6	
		.177	4,5	.295	7,5	12657	EXR 295-193	.44	11,2					
.224	5,7	.295	7,5	.413	10,5	12658	EXR 413-193	.57	14,4	.09	2,2	.47	12,0	
		.079	2,0	.197	5,0	12659	EXR 197-224	.38	9,6					
		.197	5,0	.315	8,0	12660	EXR 315-224	.50	12,7					
		.315	8,0	.453	11,5	12661	EXR 453-224	.63	15,9					

Standard color black.

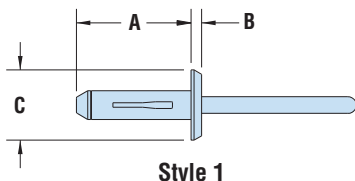

Style 1

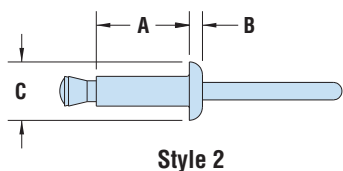

Style 2

	BR	EXR Style 1	EXR Style 2
Material	Nylon 6	Nylon 6/6 Body & Acetal (POM) Pin	Nylon 6/6 Body with Polycarbonate Pin
Flammability Rating	94V-2	94V-2 Body and 94-HB Pin	94 V-2 Body and Pin
Temperature Range	-40° F (-40°C) to 239°F (115°C) (BR)	-40° F (-40°C) to 248°F (120°C) (EXR Styles)	



HEYClip™ Drive Fasteners

WILL FIT THESE PANELS						PART NO.		DESCRIPTION	PART DIMENSIONS					
MOUNTING HOLE DIA.		ASSEMBLED PANEL THICKNESS				Black	Natural		A Length		B Head Height		C Head Diameter	
in.	mm.	Min.	Max.	in.	mm.				in.	mm.	in.	mm.	in.	mm.
.125	3,2	.04	1,0	.18	4,5	9201	9202	DF 125-039	.51	13,0	.06	1,5	.31	8,0
.154	3,9	.04	1,0	.20	5,0	9203	9204	DF 154-039	.55	14,0	.06	1,6	.35	9,0
.185	4,7	.04	1,0	.22	5,5	9205	9206	DF 185-039	.59	15,0	.07	1,7	.39	10,0
						9126	9127	DF 185-039-1	.59	15,0	.11	2,9	.43	11,0
.250	6,4	.06	1,5	.26	6,5	9128	9129	DF 250-059	.67	17,0	.08	2,0	.47	12,0
.307	7,8	.06	1,5	.28	7,0	9207	9208	DF 307-059	.75	19,0	.09	2,2	.55	14,0
.217	5,5	.24	6,0	.35	9,0	9209	9210	DF 217-236	.71	18,0	.08	2,0	.47	12,0

Standard colors black and natural.

- Heyco Drive Fasteners help secure and fasten components and/or panels to a wide variety of materials such as wood, metal, particle board, plastic and rubber.
- Hollow body design increases flexibility, for easy installation.
- Part Description Key: DF XXX-YYY where XXX = Mounting Hole Diameter (inches) and YYY = minimum Panel Thickness (inches).

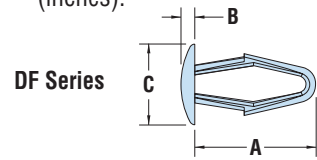

HEYClip™ Mounting Buttons

WILL FIT THESE PANELS						PART NO.		DESCRIPTION	PART DIMENSIONS					
MOUNTING HOLE DIA.		ASSEMBLED PANEL THICKNESS				Natural			A Length		B Head Height		C Head Length	
in.	mm.	Min.	Max.	in.	mm.				in.	mm.	in.	mm.	in.	mm.
.156	4,0	.031	0,8	.100	2,4	4251	HMP 156-031	.24	6,1					
		.094	2,4	.157	4,0	4252	HMP 156-094	.30	7,7					
		.189	4,8	.220	5,6	4253	HMP 156-189	.40	10,1					
		.220	5,6	.312	7,1	4254	HMP 156-220	.43	10,9					
		.312	7,9	.375	9,5	4255	HMP 156-312	.52	13,2	.19	4,8	.38	9,5	
		.375	9,5	.437	11,1	4256	HMP 156-375	.58	14,8					
		.437	11,1	.500	12,7	4257	HMP 156-437	.65	16,4					
		.500	12,7	.563	14,3	4258	HMP 156-500	.71	18,0					
		.563	14,3	.625	15,9	4259	HMP 156-563	.77	19,6					
NEW! .187	4,7	.031	0,8	.100	2,4	14251	HMP 187-031	.24	6,1					
		.094	2,4	.157	4,0	14252	HMP 187-094	.30	7,7					
		.189	4,8	.220	5,6	14253	HMP 187-189	.40	10,1					
		.220	5,6	.312	7,1	14254	HMP 187-220	.43	10,9					
		.312	7,9	.375	9,5	14255	HMP 187-312	.52	13,2	.19	4,8	.48	12,3	
		.375	9,5	.437	11,1	14256	HMP 187-375	.58	14,8					
		.437	11,1	.500	12,7	14257	HMP 187-437	.65	16,4					
		.500	12,7	.563	14,3	14258	HMP 187-500	.71	18,0					
		.563	14,3	.625	15,9	14259	HMP 187-563	.77	19,6					

Standard color natural.

- An easy and economical solution to mating objects together.
- The mounting arrowhead locks securely in place yet allows for removal from underside of board.
- Available for .156" (4,0 mm) and .187" (4,7 mm) mounting holes for panel thicknesses from .031" (0,8 mm) to .625" (15,9 mm)

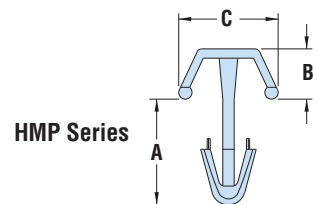

HEYClip™ Fastener Plug

WILL FIT THESE PANELS				PART NO.		DESCRIPTION	PART DIMENSIONS					
MOUNTING HOLE DIA.		MAX. ASSEMBLED PANEL THICKNESS		Black			A Length		B Head Height		C Head Diameter	
in.	mm.	in.	mm.				in.	mm.	in.	mm.	in.	mm.
.150	3,8	.311	7,9	9001		FP 150-311	.45	11,5	.07	1,8	.31	8,0

Standard color black. For other colors consult Heyco.

	DF and FP	HMP
Material	Acetal (POM)	Nylon 6/6
Flammability Rating	94-HB	94V-2
Temperature Range	-4°F (-18°C) to 220°F (104°C)	32°F (0°C) to 185°F (85°C)

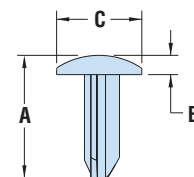



HEYClip™ Nylon Arrow Clips

Maximum Assembled Panel Sequence

- **Hollow body design** allows the clip to compress through the mounting hole, then expand back to original shape to lock assembled components securely.
- May be disassembled and reused.
- Offer a low cost way to assemble metal, plastic, composite, wood, and other thin gauge materials.
- Snap into mounting holes with fingertip pressure—no tools required.
- Vibration, abrasion, and corrosion resistant.

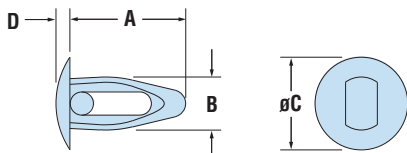

AC/ACT Series



- Webbed body design for stronger retention force.
- Part description: HMB X-Y where X = average Mounting Hole Diameter (inches) and Y = average Assembled Panel Thickness.

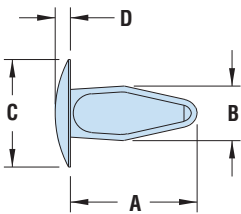

HMB Series

Quick Specs

ASSEMBLED PANEL THICKNESS RANGE				MOUNTING HOLE DIAMETER RANGE				PART NO.		DESCRIPTION	PART DIMENSIONS							
Maximum		Minimum		Maximum		Minimum		Natural	Black		A		B		C		D	
in.	mm.	in.	mm.	in.	mm.	in.	mm.				Length	Clip Dia.	Head Dia.	Head Height	in.	mm.	in.	mm.
AC Series For combined Panel Thickness $\bar{\leq}$.250" (6,4 mm)																		
.10	2,5	.04	1,0	.190	4,8	.180	4,6	0325	0325B	AC 1996	.45	11,4	.22	5,5	.36	9,1		
				.122	3,1	.118	3,0	0315	0315B	AC 15	.39	9,9	.15	3,8			.06	1,5
				.135	3,4	.130	3,3	0302	0302B	AC 2	.38	9,7	.16	4,1	.28	7,1		
				.165	4,2	.160	4,1	0318	0318B	AC 18 *	.40	10,2	.19	4,7	.28	7,1	.08	2,0
.13	3,2	.06	1,6	.192	4,9	.182	4,6	0301	0301B	AC 1	.42	10,5	.23	5,7	.36	9,1		
				.212	5,4	.192	4,9	0328	0328B	AC 28	.45	11,4	.24	6,0	.38	9,5		
				.223	5,7	.213	5,4	0307	0307B	AC 7	.45	11,4	.22	5,6	.37	9,4		
.14	3,6	.13	3,2	.132	3,4	.130	3,3	0313	0313B	AC 13	.32	8,1	.16	4,1	.28	7,1	.06	1,5
.15	3,7	.06	1,6	.161	4,1	.151	3,8	0304	0304B	AC 4	.40	10,2	.18	4,6				
.16	4,1	.06	1,6	.223	5,7	.213	5,4	0305	0305B	AC 5	.52	13,2	.25	6,3	.37	9,4		
		.17	4,2	.192	4,9	.182	4,6	0311	0311B	AC 11	.52	13,2	.21	5,2				
.19	4,7	.06	1,6	.223	5,7	.213	5,4	0326	0326B	AC 1668	.49	12,5	.25	6,3	.63	15,9	.10	2,5
		.13	3,2	.260	6,6	.250	6,4	0309	0309B	AC 9	.58	14,6	.29	7,4	.48	12,3	.07	1,8
ACT Series For combined Panel Thickness $>$.250" (6,4 mm)																		
.30	7,6	.29	7,4	.150	3,8	.145	3,7	0314	0314B	ACT 14	.53	13,5	.20	5,0	.27	6,9		
.34	8,6	.06	1,6	.335	8,5	.320	8,1	0317	0317B	ACT 17	.90	22,9	.38	9,5	.68	17,3	.07	1,7
.38	9,7	.36	9,1	.260	6,6	.250	6,4	0316	0316B	ACT 16	.81	20,6	.28	7,0	.61	15,5		

Standard color natural. Consult Heyco for black and other colors.

*AC 18 minimum panel thickness is .03" (0,8 mm), head height is .08" (2,0 mm)



HEYClip™ Shorty Mounting Buttons

ASSEMBLED PANEL THICKNESS RANGE				MOUNTING HOLE DIAMETER RANGE				PART NO.		DESCRIPTION	PART DIMENSIONS							
Maximum		Minimum		Maximum		Minimum		Natural	Black		A		B		C		D	
in.	mm.	in.	mm.	in.	mm.	in.	mm.				Length	Clip Dia.	Head Dia.	Head Height	in.	mm.	in.	mm.
.08	2,1	.06	1,5	.126	3,2	.122	3,1	4138	-	HMB 124-07	.24	6,0	.13	3,4	.28	7,0	.05	1,2
.14	3,5	.08	2,0	.126	3,2	.118	3,0	4139	-	HMB 122-11	.32	8,3	.14	3,5	.29	7,4	.06	1,4
.10	2,5	.08	2,0	.127	3,2	.122	3,1	4199	4199B	HMB 125-09	.33	8,4	.09	2,2	.28	7,1	.05	1,2
		.11	2,9	.141	3,6	.131	3,3	4200	4200B	HMB 136-13.5	.44	11,1	.13	3,2	.41	10,3	.07	1,7
.16	4,0	.10	2,5	.192	4,9	.181	4,6	4201	4201B	HMB 187-13	.43	10,9	.16	4,0	.50	12,7	.09	2,2
.25	6,4	.13	3,2	.260	6,6	.250	6,4	0321	0321B	HMB 255-19	.63	16,0	.28	7,1	.50	12,7	.05	1,3
.33	8,4	.31	7,9	.192	4,9	.182	4,6	0306	0306B	HMB 187-32	.55	14,0	.23	5,7	.38	9,7	.06	1,5
.75	19,1	.50	12,7	.260	6,6	.250	6,4	0324	0324B	HMB 255-62.5	1.14	28,8	.29	7,3	.61	15,5	.07	1,7

Standard color natural and black except for Part Nos. **4138** and **4139**

Material	Nylon 6/6
Flammability Rating	94V-2
Temperature Range	32°F (0°C) to 185°F (85°C)



HEYClip™ Nylon Kayak Clips

Maximum Assembled Panel Sequence

ASSEMBLED PANEL THICKNESS RANGE				MOUNTING HOLE DIAMETER RANGE				PART NO.	DESCRIPTION	PART DIMENSIONS								Head Type	Style
Maximum	Minimum	Maximum	Minimum	A	B	C	D			Length	Clip Dia.	Head Dia.	Head Height	in.	mm.	in.	mm.		
KC Series																			
.09	2,3	.06	1,5	.140	3,6	.135	3,4	4272	KC 09-14	.33	8,4	.16	4,1	.30	7,6	.06	1,5	TRUSS	
.09	2,3	.06	1,5	.141	3,6	.131	3,3	4273	KC 09-14-1	.27	6,9	.16	4,1	.40	10,2	.15	3,8	ROUND	2
.10	2,5	.08	2,0	.127	3,2	.123	3,1	4274	KC 10-13	.33	8,4	.13	3,3	.27	6,9	.04	1,0	TRUSS	
.13	3,3	.08	2,0	.141	3,6	.131	3,3	4275	KC 13-14	.37	9,4	.17	4,3	.41	10,4	.10	2,5	PAN	1
				.205	5,2	.175	4,4	4276	KC 13-21	.43	10,9	.21	5,3	.50	12,7	.25	6,4	ROUND	2
.14	3,6	.07	1,8	.150	3,8	.125	3,2	4278	KC 14-15	.43	10,9	.16	4,1	.30	7,6	.10	2,5	ROUND	1
				.200	5,1	.185	4,8	4277	KC 13-20	.44	11,2	.21	5,3	.37	9,4	.05	1,3	BINDING	2
.16	4,1	.10	2,5	.192	4,9	.182	4,6	4279	KC 16-19	.43	10,9	.21	5,3	.37	9,4	.06	1,5	TRUSS	1
				.200	5,1	.185	4,7	4282	KC 16-20	.44	11,2	.21	5,3	.38	9,7	.06	1,5	BINDING	2
.21	5,3	.09	2,3	.220	5,6	.200	5,1	4283	KC 21-22	.50	12,7	.24	6,1	.52	13,2	.07	1,8	PAN	2
				.275	7,0	.240	6,1	4284	KC 21-28	.63	16,0	.29	7,4	.50	12,7	.05	1,3	BINDING	1
.22	5,6	.10	2,5	.280	7,1	.245	6,2	4285	KC 22-28	.63	16,0	.29	7,4	.86	21,8	.09	2,3	TRUSS	1
				.260	6,6	.240	6,1	4286	KC 22-26	.46	11,7	.29	7,4	.45	11,4	.06	1,5	PAN	

Standard color natural. Consult Heyco for black and other colors.

- A low cost replacement for screws and rivets.
- Snap into round mounting holes.
- Fasten securely into a variety of materials.
- Ideal for assembling lightweight panels and components.

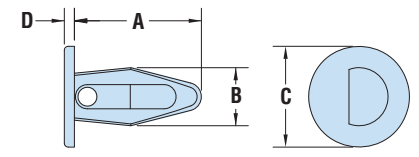

Style 1

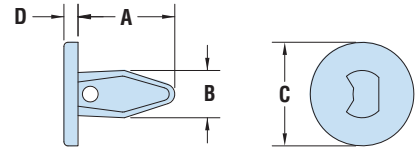

Style 2



HEYClip™ Nylon Holster Clips

Mounting Hole Diameter/Assembled Panel Thickness Sequence

MOUNTING HOLE DIA.		ASSEMBLED PANEL THICKNESS		PART NO.	DESCRIPTION	HEAD DIAMETER			
in.	mm.	in.	mm.			in.	mm.		
HHC Series									
.219	5,6	.093	2,3	4287	HHC 09-22	.34	8,6		
		.125	3,3	4289	HHC 13-22				
		.156	4,1	4292	HHC 16-22				
		.187	4,8	4294	HHC 19-22				
		.219	5,5	4295	HHC 22-22				
		.250	6,4	4296	HHC 25-22				
		.281	7,1	4297	HHC 28-22				
		.312	7,9	4298	HHC 31-22				
		.343	8,6	4299	HHC 34-22				
.250	6,4	.375	9,7	4322	HHC 38-22	.50	12,7		
		.093	2,3	4288	HHC 09-25			.31	7,9
		.156	4,1	4293	HHC 16-25				

Standard color natural. Consult Heyco for black and other colors.

- Holster shaped interior allows the part to collapse more completely, for assembly with just **fingertip pressure**.
- Tapered, bullet-style point **slides easily** into any mounting hole.
- Angled panel locking section **takes up slack** to provide for a tight assembly.
- The design allows for a relatively large clip-diameter-to-hole-size ratio, resulting in **higher retention force**.
- Consult Heyco for other mounting hole and panel thickness **variations**.

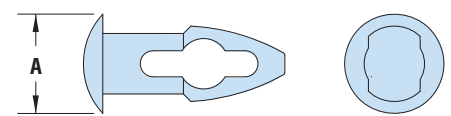

Quick Specs

Material	Nylon 6/6
Flammability Rating	94V-2
Temperature Range	32°F (0°C) to 185°F (85°C)



HEYClip™ Nylon Push-In and Thick Panel Push-In Fasteners

Assembled Panel Thickness Sequence

- **Slotted leg design** allows for both compression through the mounting hole and then expansion back to original shape—to lock assembled components securely.
- May be disassembled and reused.
- Offer a low cost way to assemble metal, plastic, composite, wood, and other thin gauge materials.
- Snap into mounting holes with fingertip pressure—no tools required.
- Vibration, abrasion, and corrosion resistant.

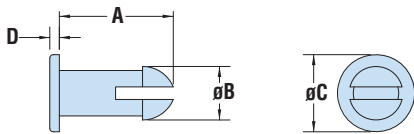

ASSEMBLED PANEL THICKNESS	MOUNTING HOLE DIA.		PART NO.		DESCRIPTION	PART DIMENSIONS								
						A		B		C		D		
in. mm.	in. mm.	Natural	Black	A Length	B Clip Dia.	C Head Dia.	D Head Height	in. mm.	in. mm.	in. mm.	in. mm.	in. mm.	in. mm.	
PF Series For combined Panel Thickness $\bar{\leq}$.250" (6,4 mm)														
.07	1,7	.165	4,2	0351	0351B	PF 065-165	.20	5,1	.20	5,1	.34	8,7	.12	3,1
.09	2,4	.093	2,4	0340	0340B	PF 093-093*	.17	4,3	.11	2,7	.28	7,1	.03	0,7
.10	2,5	.245	6,2	0384	0384B	PF 098-245	.27	6,8	.28	7,1	.50	12,7	.06	1,4
.12	2,9	.093	2,4	0339	0339B	PF 115-125	.20	5,1	.15	3,7	.25	6,4	.04	1,0
.12	3,1	.089	2,3	0341	0341B	PF 121-089*	.21	5,3	.15	3,7	.31	7,9	.04	1,0
		.115	2,9	0347	0347B	PF 121-115	.25	6,2	.14	3,6	.20	5,2		
.13	3,4	.175	4,4	0350	0350B	PF 121-200	.27	6,9	.24	6,1	.47	11,9	.05	1,3
		.200	5,1	0358	0358B	PF 133-175	.27	6,9	.20	5,1	.34	8,7	.04	1,0
.16	4,0	.115	2,9	0343	0343B	PF 156-115	.29	7,4	.14	3,6	.20	5,2	.04	1,0
		.210	5,3	0360	0360B	PF 156-210	.31	7,8	.23	5,8	.47	11,9	.05	1,3
.17	4,3	.260	6,6	0370	0370B	PF 171-260	.36	9,1	.30	7,5	.59	15,1	.06	1,5
.19	4,8	.130	3,3	0342	0342B	PF 190-155	.28	7,1	.18	4,6	.20	5,2	.04	1,0
.24	6,0	.200	5,1	0352	0352B	PF 237-200	.39	9,8	.24	6,0	.47	11,9	.05	1,3
.25	6,4	.200	5,1	0353	0353B	PF 250-200	.42	10,8	.22	5,7	.34	8,7	.06	1,5
		.218	5,5	0362	0362B	PF 250-218	.36	9,1	.28	7,2	.41	10,3	.05	1,1
		.240	6,1	0371	0371B	PF 250-240	.43	10,9	.30	7,5	.59	15,1	.06	1,5

PFT Series For combined Panel Thickness $>$.250" (6,4 mm)														
.27	6,9	.155	4,0	0303	-	PFT 27-16	.40	10,0	.21	5,3	.38	9,5	.07	1,7
.27	6,9	.240	6,1	0308	-	PFT 27-24	.46	11,7	.30	7,6	.45	11,4	.06	1,5
.28	7,0	.240	6,1	0310	-	PFT 28-24	.46	11,7	.30	7,6	.45	11,4	.04	1,0
.32	8,1	.157	4,0	0312	-	PFT 32-16	.43	10,9	.21	5,3	.39	9,9	.05	1,3
.32	8,1	.118	3,0	0319	-	PFT 32-12	.40	10,2	.15	3,7	.23	5,9	.03	0,8
.34	8,6	.174	4,4	0322	-	PFT 34-17	.51	13,0	.25	6,4	.33	8,4	.07	1,8
.37	9,4	.245	6,2	0323	-	PFT 37-25	.55	14,0	.30	7,6	.59	15,0	.13	3,3
.38	9,7	.200	5,1	0361	-	PFT 38-20	.51	13,0	.24	6,0	.34	8,7	.04	1,0
		.240	6,1	0327	-	PFT 38-24	.56	14,2	.30	7,6	.59	15,0	.06	1,5
.40	10,2	.135	3,4	0329	-	PFT 40-14	.54	13,7	.16	4,1	.28	7,1	.08	2,0
.41	10,3	.275	7,0	0330	-	PFT 41-28	.57	14,5	.32	8,1	.59	15,0	.06	1,5
.43	10,8	.135	3,4	0331	-	PFT 43-14	.64	16,3	.16	4,1	.42	10,7	.09	2,3
.48	12,2	.240	6,1	0332	-	PFT 48-24	.67	17,0	.30	7,6	.59	15,0	.06	1,5
.55	14,0	.180	4,6	0333	-	PFT 55-18	.71	18,0	.23	5,8	.35	8,9	.07	1,8
.70	17,8	.245	6,2	0334	-	PFT 70-25	.90	22,9	.34	8,6	.50	12,7	.08	2,0
.88	22,4	.246	6,3	0335	-	PFT 88-24	1.12	28,5	.28	7,1	.38	9,7	.06	1,5
		.250	6,4	0336	-	PFT 88-25	1.13	28,7	.31	7,9				
.89	22,6	.260	6,6	0337	-	PFT 89-26	.95	24,1	.34	8,6	.41	10,4	.07	1,8
1.00	25,4	.345	8,9	0338	-	PFT 100-35	1.38	35,1	.45	11,4	.50	12,7	.07	1,8
1.02	25,9	.350	8,9	0344	-	PFT 102-35	1.40	35,6	.48	12,2	.50	12,7	.06	1,5

Standard color natural. Consult Heyco for black and other colors.

*No slot.

Quick Specs

Material	Nylon 6/6
Flammability Rating	94V-2
Temperature Range	32°F (0°C) to 185°F (85°C)

HEYClip™ Nylon Snap Lock Pins

MOUNTING HOLE DIA.		ASSEMBLED PANEL THICKNESS		PART NO.	DESCRIPTION	PART DIMENSIONS							
in.	mm.	in.	mm.			A Length		B Clip Dia.		C Head Dia.		D Head Height	
				Natural		in.	mm.	in.	mm.	in.	mm.	in.	mm.
SLP1 Series - Flush Head													
.098	2.5	.177	4,5	12040	SLP1-177	.26	6,6						
		.221	5,6	12041	SLP1-221	.30	7,6						
		.236	6,0	12042	SLP1-236	.31	7,9						
		.245	6,2	12043	SLP1-245	.32	8,1						
		.307	7,8	12044	SLP1-307	.39	9,9						
		.316	8,0	12045	SLP1-316	.40	10,0	.09	2,4	.20	5,1	.05	1,3
		.330	8,4	12046	SLP1-330	.41	10,4						
		.413	10,5	12047	SLP1-413	.49	12,4						
		.638	16,2	12048	SLP1-638	.72	18,3						
		.660	16,8	12049	SLP1-660	.74	18,8						
.701	17,8	12050	SLP1-701	.78	19,8								

MOUNTING HOLE DIA.		ASSEMBLED PANEL THICKNESS		PART NO.	DESCRIPTION	PART DIMENSIONS							
in.	mm.	in.	mm.			A Length		B Clip Dia.		C Head Dia.		D Head Height	
				Natural		in.	mm.	in.	mm.	in.	mm.	in.	mm.
SLP100 Series - Lip Under Head ALL NEW!													
.098	2.5	.177	4,5	12051	SLP100-177	.26	6,6						
		.221	5,6	12052	SLP100-221	.30	7,6						
		.236	6,0	12053	SLP100-236	.31	7,9						
		.245	6,2	12054	SLP100-245	.32	8,1						
		.307	7,8	12055	SLP100-307	.39	9,9						
		.316	8,0	12056	SLP100-316	.40	10,0	.09	2,4	.20	5,1	.06	1,5
		.330	8,4	12057	SLP100-330	.41	10,4						
		.413	10,5	12058	SLP100-413	.49	12,4						
		.638	16,2	12059	SLP100-638	.72	18,3						
		.660	16,8	12060	SLP100-660	.74	18,8						
.701	17,8	12061	SLP100-701	.78	19,8								

Standard color natural. Consult Heyco for black and other colors.

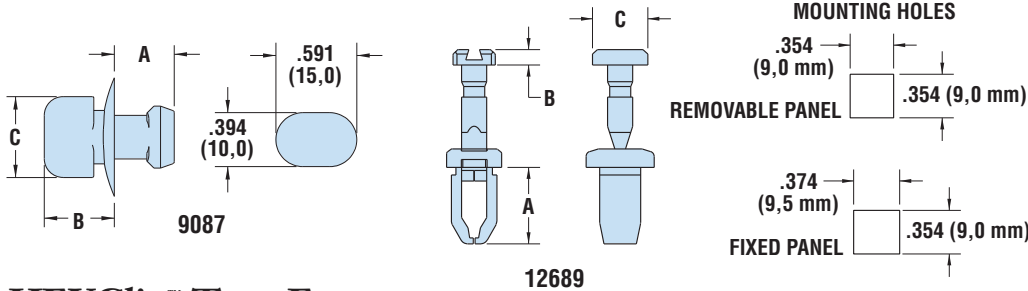

HEYClip™ Turn Fastener

WILL FIT THESE PANELS						PART NO.	DESCRIPTION	PART DIMENSIONS					
MOUNTING HOLE		ASSEMBLED PANEL THICKNESS						Black	A Length		B Head Height		C Head Length
in.	mm.	in.	mm.	in.	mm.		in.		mm.	in.	mm.	in.	mm.
.39 x .59	10,0 x 15,0	.24	6,0	.28	7,0	9087	TF 394-236	.44	11,1	.51	13,0	.59	15,0
see schematic		.09	2,4	.11	2,7	12689	TF 354-354	.48	12,2	.13	3,2	.45	11,4 NEW!

Standard color black.

HEYClip™ Nylon Pawl Locks

WILL FIT THESE PANELS						PART NO.	DESCRIPTION	PART DIMENSIONS					
MOUNTING HOLE DIA.		ASSEMBLED PANEL THICKNESS						A Length	B Head Height		C Head Diameter		
in.	mm.	in.	mm.	in.	mm.	in.	mm.		in.	mm.	in.	mm.	
.250	6,4	.03	0,8	.29	7,4	10677B	HPFP - 1 Black	.41	10,4	.08	2,0	.72	18,3 NEW!
		.16	4,0	.55	13,9	10676	HPL - 1 Natural	.63	15,9	.08	2,0	.50	12,7

Standard color as shown.

Material	Nylon 6/6
Flammability Rating	94V-2
Temperature Range	-4°F (-18°C) to 185°F (85°C)



• Used to fix connectors to the printed circuit board prior to wave soldering.

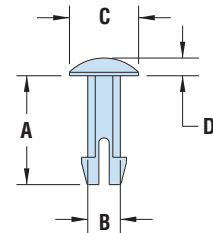

SLP1 Series

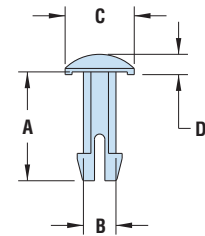

SLP100 Series



• Part Description Key:
TF X-YYY where XXX = Mounting Hole Diameter (inches) and YYY = minimum Panel Thickness (inches)

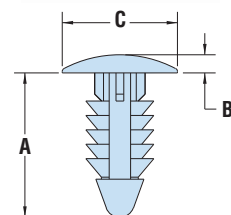

HPL-1 Series



Heyco® Rubber Push-In Bumpers

- Rubber bumpers are designed for through hole installation.
- Designed to fit snugly into your opening and not let air, water, etc. pass through.
- Can also be used as feet.
- For Heyco Adhesive-Backed Bumpers see page 75.
- Part Description Key: RGB X-Y-Z where X = Mounting Hole Diameter (inches), Y = Base Diameter (inches), and Z/32 = Base Height (inches).

PANEL DIMENSIONS				PART NO.	DESCRIPTION	MATERIAL	PART DIMENSIONS							
Mounting Hole Dia. in. mm.	Maximum Thickness in. mm.		Black				A Base Diameter in. mm.		B Base Height in. mm.		C Insert Diameter in. mm.		D Insert Height in. mm.	
	Type H													
.203	5,2	.078	2,0	G3116	RGB 203-812-6	Santoprene	.81	20,6	.19	4,7				
				G3117	RGB 203-812-8	Santoprene	.81	20,6	.25	6,4	.22	5,6	.20	5,1
				G3118	RGB 203-812-12	Santoprene	.81	20,6	.38	9,5				
Type D														
.218	5,5	.093	2,4	G2016	RGB 218-406-6	SBR	.41	10,4	.19	4,8	.28	7,1	.09	2,3
.250	6,4	.047	1,2	G2020	RGB 250-500-6	SBR	.50	12,7	.17	4,3	.31	7,9	.19	4,8
.312	7,9	.062	1,6	G2035	RGB 312-375-5	SBR	.38	9,7	.16	4,1	.38	9,7	.16	4,1
.328	8,3	.094	2,4	G2039	RGB 328-846-6	SBR	.85	21,5	.19	4,8	.42	10,7	.27	6,9
.500	12,7	.125	3,2	G2043	RGB 500-1000-6	SBR	1.00	25,4	.19	4,8	.63	16,0	.13	3,3
Type T1														
.118	3,0	.098	2,5	G2000	RGB 118-236-4	EPDM	.24	6,1	.12	3,0	.20	5,1	.47	11,9
.177	4,5	.059	1,5	G2006	RGB 177-334-9	SBR	.33	8,4	.30	7,6	.24	6,1	.73	18,5
.218	5,5	.125	3,2	G2017	RGB 218-875-6	SBR	.88	22,4	.17	4,3	.34	8,7	.58	14,7
Type T2*														
.187	4,7	.047	1,2	G2009	RGB 187-250-6	SBR	.25	6,4	.19	4,7	.23	5,8	.34	8,6

Standard color black.

*Designed for pull through applications.

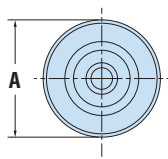

Type H

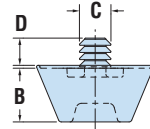

Type D

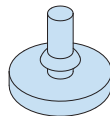
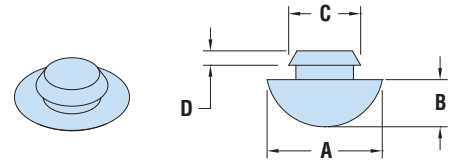

Type T1

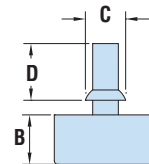
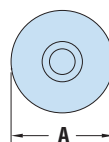

Type T2

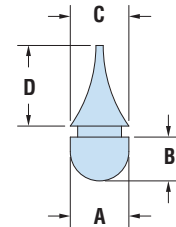

Quick
Specs

Material
Temperature Range

TPE, SBR, or EPDM
-40°F (-40°C) to 221°F (105°C)



Heyco® Rubber Push-In Bumpers

PANEL DIMENSIONS				PART NO.	DESCRIPTION	MATERIAL	PART DIMENSIONS							
Mounting Hole Dia. in. mm.	Maximum Thickness in. mm.	Black					A Base Diameter in. mm.		B Base Height in. mm.		C Insert Diameter in. mm.		D Insert Height in. mm.	
				Type F1										
.156	4,0	.031	0,8	G2004	RGB 156-375-3	SBR	.38	9,7	.09	2,3	.22	5,6	.11	2,8
.250	6,4	.062	1,6	G2024	RGB 250-500-5	SBR	.50	12,7	.14	3,6	.31	7,9	.13	3,3
			1,6	G2025	RGB 250-500-8	SBR	.50	12,7	.25	6,4				
.281	7,1	.125	3,2	G2027	RGB 250-562-4	SBR	.56	14,2	.13	3,3	.34	8,6	.16	4,1
			2,0	G2031	RGB 281-562-4	SBR	.56	14,2	.13	3,3	.38	9,7		
.500	12,7	.188	4,8	G2032	RGB 281-625-11	SBR	.63	16,0	.34	8,6	.44	11,2	.17	4,3
			4,8	G2044	RGB 500-1000-10	SBR	1.00	25,4	.31	7,9	.69	17,5	.19	4,8
Type F2														
.187	4,7	.062	1,6	G2012	RGB 187-375-4	SBR	.38	9,7	.13	3,3	.25	6,4	.13	3,3
.188	4,8	.062	1,6	G2013	RGB 188-500-3	Nitrile	.50	12,7	.09	2,3	.25	6,4	.19	4,8
			1,3	G2021	RGB 250-562-12	SBR	.56	14,2	.38	9,7	.34	8,6	.27	6,9
.250	6,4	.062	1,6	G2022	RGB 250-375-4	SBR	.38	9,7	.13	3,3	.31	7,9	.06	1,5
			1,6	G2023	RGB 250-375-4R*									
.281	7,1	.125	3,2	G2026	RGB 250-406-7	Nitrile	.41	10,4	.22	5,6	.34	8,6	.16	4,1
			1,2	G2029	RGB 281-500-2	Nitrile	.50	12,7	.06	1,5	.38	9,7		
.312	7,9	.047	1,2	G2030	RGB 281-500-4	SBR	.50	12,7	.13	3,3	.44	11,2	.08	2,0
			1,2	G2034	RGB 312-1250-3	SBR	1.25	31,8	.09	2,3				
.312	7,9	.078	2,0	G2036	RGB 312-875-4	SBR	.88	22,4	.13	3,3	.50	12,7	.06	1,5
			Type F3											
.156	4,0	.109	2,8	G2007	RGB 156-500-2	SBR	.50	12,7	.06	1,5	.25	6,4	.08	2,0
.188	4,8	.047	1,2	G2010	RGB 188-312-4	SBR	.31	7,9	.13	3,3	.25	6,4	.09	2,3
.187	4,7	.050	1,3	G2011	RGB 187-375-8	SBR	.38	9,7	.25	6,4	.25	6,4	.09	2,3
.188	4,8	.078	2,0	G2014	RGB 188-338-6**	SBR	.34	8,6	.17	4,3	.25	6,4	.30	7,6
.250	6,4	.047	1,2	G2019	RGB 250-437-6	SBR	.44	11,2	.19	4,8	.31	7,9	.13	3,3
.312	7,9	.094	2,4	G2037	RGB 312-625-8	SBR	.63	16,0	.25	6,4	.38	9,7		
Special Bumpers														
.148	3,8	.125	3,3	G2003	RGB 148-310-1	TPE	.31	7,9	.06	1,5	.17	4,3	.14	3,6
.180	4,6	.062	1,6	G2005	RGB 180-310-3	TPE	.31	7,9	.09	2,3	.24	6,1	.12	3,0
.238	6,0	.075	1,9	G2015	RGB 238-620-6**	TPE	.53	13,4	.18	4,6	.29	7,4	.34	8,6
.281	7,1	.051	1,3	G2028	RGB 281-620-6**	TPE	.62	15,7	.20	5,1	.34	8,6	.16	4,1
.378	9,6	.063	1,6	G2038	RGB 378-500-15**	TPE	.50	12,7	.48	12,2	.50	12,7	.14	3,6

- Rubber bumpers are designed for through hole installation.
- Designed to fit snugly into your opening and not let air, water, etc. pass through.
- Can also be used as feet.
- For Heyco Adhesive-Backed Bumpers see page 7-91.
- Part Description Key: RGB X-Y-Z where X = Mounting Hole Diameter (inches), Y = Base Diameter (inches), and Z/32 = Base Height (inches).

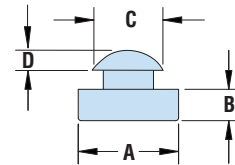

Type F1

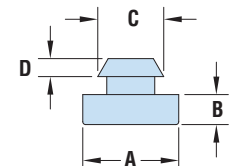

Type F2

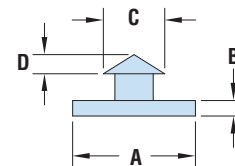

Type F3

Standard color black. *Part number G2023 has a round insertion head. **Part has a hollow core.

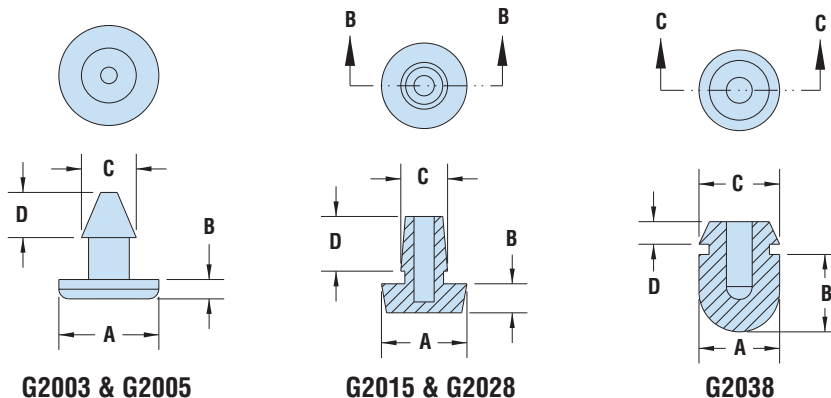

G2003 & G2005

G2015 & G2028

G2038

Material: SBR or Nitrile
 Temperature Range: -40°F (-40°C) to 221°F (105°C)

Quick Specs

"Stay Connected" with



HEYware

a PennEngineering® Company



- Bumpers can be used as mounting feet to prevent equipment from sliding or moving.
- Designed for through hole installation.
- 60-70 Durometer Range.
- 29 sizes available that will accommodate various mounting holes and panel thicknesses.
- Provide vibration dampening.

Heyco® Screw-In Rubber Pocket Bumpers

A Outside Diameter		PART DIMENSIONS				D Recess Depth		BLACK PART NO.		E Fastener Hole Dia.*	
		B Overall Height		C Recess Diameter				No Washer	With Steel Washer		
in.	mm.	in.	mm.	in.	mm.	in.	mm.			in.	mm.
Type RS											
.50	12,7	.25	6,4	.25	6,4	.16	4,0	-	G2201	.13	3,2
.63	15,9	.38	9,5	.25	6,4	.19	4,7	-	G2205		
.75	19,1	.38	9,5	.32	7,9	.19	4,7	-	G2209	.16	4,0
.81	20,6	.72	18,3	.38	9,5	.28	7,1	-	G2213	.22	5,5
1.00	25,4	.81	20,6	.25	6,4	.44	11,1	-	G2217	.13	3,2
		1.00	25,4	.31	7,9	.63	15,9	G2220	G2221	.16	4,0
1.09	27,7	.63	15,9	.44	11,1	.41	10,3	-	G2225	.19	4,7
Type RR											
.50	12,7	.25	6,4	.25	6,4	.16	4,0	-	G2229	.09	2,4
.75	19,1	.56	14,3	.38	9,5	.25	6,4	-	G2233	.19	4,7
		.75	19,1	.31	7,9	.25	6,4	-	G2237	.13	3,2
.81	20,6	.81	20,6	.47	11,9	.44	11,1	-	G2241	.25	6,4
.94	23,8	.35	8,9	.38	9,5	.18	4,6	-	G2245	.19	4,7
		.38	9,5	.38	9,5	.22	5,5	G2244	-		
.97	24,6	.34	8,7	.38	9,5	.19	4,7	-	G2249		
1.00	25,4	.44	11,1	.38	9,5	.19	4,7	-	G2253		
		.50	12,7	.50	12,7	.25	6,4	-	G2257	.22	5,5
		.56	14,3	.53	13,5	.31	7,9	-	G2261	.28	7,1
1.25	31,8	1.25	31,8	.38	9,5	.75	19,1	-	G2267	.25	6,4
		1.88	47,6	.38	9,5	.75	19,1	-	G2271		
1.50	38,1	.63	15,9	.50	12,7	.34	8,7	-	G2275	.19	4,7
		.75	19,1	.75	19,1	.34	8,7	G2278	G2279	.31	7,9
		.75	19,1	.47	11,9	.50	12,7	-	G2283	.25	6,4
1.70	43,2	1.12	28,4	.60	15,2	.72	18,3	G2286			
1.71	44,5	1.66	44,5	.62	15,9	.50	12,7	G2290			
2.50	63,5	1.00	25,4	1.13	28,6	.50	12,7	G2294	-	.38	9,6
								G2296†			
								G2298†			
		2.00	50,8	1.13	28,6	1.25	28,6	G2302			
Type S											
1.00	25,4	.50	12,7	.36 / .43	9,0 / 10,9	.20 / .16	5,0 / 4,1	-	G2307	.19	4,7
1.50	38,1	.75	19,1	.75	19,1	.38	9,5	-	G2311	.25	6,4

Standard color black. Standard material SBR (Styrene Butadiene Rubber), 60-70 durometer.

*Fastener not included.

†Part Nos. G2296 and G2298 are made from White SBR, 60-70 durometer.

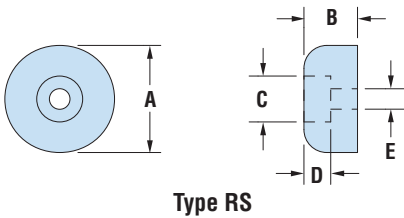

Type RS

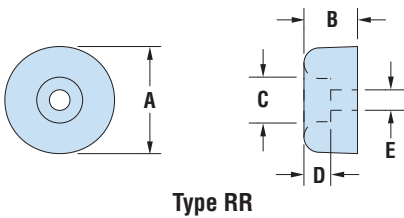

Type RR

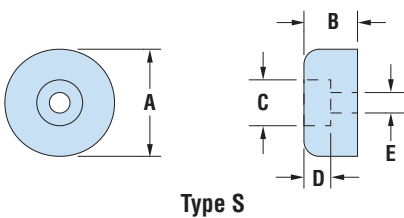

Type S

Quick Specs

Material
Temperature Range

SBR
-40°F (-40°C) to 221°F (105°C)



Heyco® Polyurethane Adhesive-Back Bumpers

PART DIMENSIONS				PART NO.		DESCRIPTION	Pieces per Sheet	
A Diameter		B Height		Clear	Black			
in.	mm.	in.	mm.					
HSA Series - Hemi								
.25	6,4	.06	1,6	N040	N140	HBA 250-06	578	
.31	7,9	.09	2,3	N027	N127	HBA 312-09	450	
.34	8,6	.09	2,3	N007	N107	HBA 335-09		
.38	9,7	.15	3,8	N012	N112	HBA 375-15		200
.44	11,2	.20	5,1	N002	N102	HBA 440-20	242	
.62	15,7	.31	7,9	N015	N115	HBA 620-31	128	
.70	17,8	.38	9,7	N008	N108	HBA 700-38	98	
.75	19,1	.08	1,9	N039	N139	HBA 750-08	84	
CBA Series - Cylinder								
NEW!	.38	9,7	.13	3,2	N034	N134	CBA 370-13	300
			.19	4,8	N035	N135	CBA 370-19	200
NEW!	.50	12,7	.06	1,5	N005	N105	CBA 500-06	200
			.14	3,6	N001	N101	CBA 500-14	
			.25	6,4	N006	N106	CBA 500-25	
			.40	10,2	N011	N111	CBA 650-40	
.78	19,8	.20	5,1	N041	N141	CBA 780-20	84	
.81	20,6	.12	3,0	N024	N124	CBA 810-12	72	
CDBA Series - Pocket								
.50	12,7	.14	3,6	N018	N118	CDBA 500-14	200	
.88	22,4	.40	10,2	N017	N117	CDBA 880-40	72	
1.81	46,0	.60	15,2	N030	N130	CDBA 1810-60	1	
TBA Series - Square or Tapered								
NEW!	.40	10,2	.10	2,5	N020	N120	TBA 4040-10	242
NEW!	.50	12,7	.12	3,0	N009	N109	TBA 5050-12	200
			.23	5,8	N03R	N13R	TBA 5050-23	
.81	20,6	.30	7,6	N019	N119	TBA 8181-30	98	

Standard colors clear and black. For white, gray or brown consult Heyco.

- Quick and easy installation—simply peel off backing and press into place. With no holes to drill, and no screws or rivets needed, adhesive backed bumpers will save you time and money.
- Bumpers can be attached to a wide variety of surfaces; aluminum, ceramic, formica, glass, painted surfaces, polyethylene, polypropylene, vinyl, and steel.
- Adhesive backed bumpers are nonmarking, nonstaining, skid, and scratch resistant.
- Surface must be clean, dry, and free of grease, oil, and other common solvents to obtain maximum adhesion. Clean surfaces with low strength solvents such as Isopropyl Alcohol or Heptane.
- Bumpers have a rubber-based pressure sensitive adhesive with an end use temperature of 0°F (-18°C) to 180°F (82°C).
- Standard colors clear and black. White, gray and brown available, please consult Heyco.

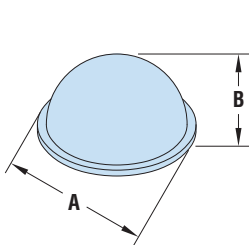

HSA-Hemi

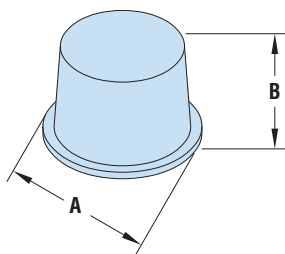

CBA-Cylinder

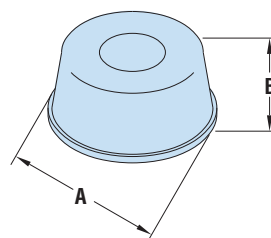

CDBA-Pocket

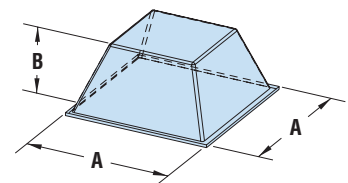

TBA-Square or Tapered

Material	Polyurethane
Certifications	 Recognized under the Component Program of Underwriters' Laboratories File E196663
Flammability Rating	HB
Temperature Range	0°F (-18°C) to 180°F (82°C)

Quick
Specs



- Part Description Key: RGBA X-Y-Z where X = Mounting Hole Diameter (inches), Y = Base Diameter (inches), and Z = Durometer.

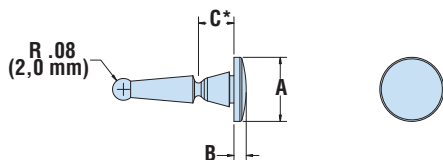

G2312-G2314

Heyco® Break-Away Bumpers

PANEL DIMENSIONS				PART NO.	DESC.	MATERIAL	PART DIMENSIONS					
Mounting Hole Dia.		Thickness					A Base Diameter		B Base Height		C Insert Height*	
in.	mm.	in.	mm.	Black			in.	mm.	in.	mm.	in.	mm.
RGBA Series												
.187-.197	4,7-5,0	.02	0,5	G2312	RGBA 19-39-50	Silicone Rubber 50	.39	10,0	.08	2,0	.17	4,3
.197-.212	5,0-5,4	.02-.03	0,6-0,8	G2313	RGBA 20-47-40	Silicone Rubber 40	.47	12,0	.09	2,3	.26	6,5
				G2314	RGBA 20-47-50	Silicone Rubber 50						

Standard color black. * Approximate: after Lead Stem is broken off.



Heyco® Feet of Strength Feet with Drive Pin

PART DIMENSIONS					PANEL DIMENSIONS						PART NO. Black	DESCRIPTION	
A Overall Height	B Top Diameter	C Bottom Diameter		Mounting Hole Diameter	Thickness Range								
in.	mm.	in.	mm.	in.	mm.	in.	mm.	in.	mm.	Black			
FSD / FSS * Series													
.20	5,0	.98	25,0	.91	23,0	.299	7,6	.03	0,8	.06	1,5	2543	FSD 20-30-06
		.79	20,0	.71	18,0	.303	7,7	.03	0,8	.06	1,5	2537	FSD 20-32-06
.24	6,0	.83	21,0	.79	20,0	.303	7,7	.20	5,0	.32	8,0	2544	FSD 24-31-32
						.200	5,0	.04	1,0	.09	2,3	2536*	FSS 39-20-09
.39	10,0	.79	20,0	.71	18,0	.310	7,8	.03	0,8	.06	1,5	2545	FSD 39-30-06
						.320	8,1	.03	0,8	.06	1,5	2548	FSD 39-32-06
.47	12,0	.79	20,0	.71	18,0	.320	8,1	.02	0,5	.05	1,2	2547	FSD 47-32-05
.55	14,0	.95	24,0	.79	20,0	.200	5,0	.04	1,0	.09	2,3	2538 *	FSS 55-20-09
.59	15,0	.79	20,0	.71	18,0	.320	8,1	.03	0,8	.07	1,8	2549	FSD 59-32-07
		1.18	30,0	1.10	28,0	.200	5,0	.02	0,5	.06	1,5	2539 *	FSS 59-20-06
.71	18,0	.79	20,0	.71	18,0	.320	8,1	.02	0,5	.05	1,2	2551	FSD 71-32-05

Standard color black. * Slotted Screw replaces Drive Pin.

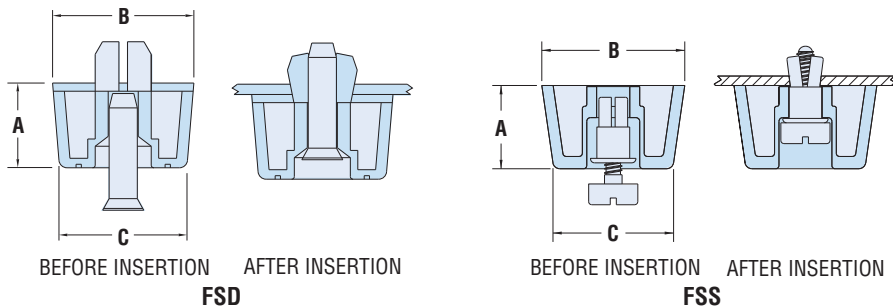

- Molded of thermoplastic elastomer or polypropylene and elastomer blend for **skid and vibration resistance**.
- Two piece construction comes preassembled.
- To install, simply insert into the mounting hole, then press pin to secure.
- Part Description Key: FSD/FSS XX-YY-ZZ where XX = Overall Height (inches), YY = Mounting Hole Diameter (inches) and ZZ = Maximum Panel Thickness (inches)

Quick Specs

Material	RGBA	Silicone Rubber
Temperature Range		-40°F (-40°C) to 302°F (150°C)
Material	FSD	Thermoplastic elastomer or Polypropylene & elastomer



Heyco® Feet of Strength Feet with Push Rivet

PART DIMENSIONS						PANEL DIMENSIONS				PART NO. Black	DESCRIPTION				
A Overall Height	B Top Diameter		C Bottom Diameter		Mounting Hole Diameter	Thickness Range									
	in.	mm.	in.	mm.		Minimum		Maximum							
in.	mm.	in.	mm.	in.	mm.	in.	mm.	in.	mm.						
FSR Series															
.16	4,0	.43	10,8	.39	10,0	.142	3,6	.02	0,5	.05	1,2	2519	FSR 16-14-05		
								.05	1,2	.08	2,0	2520	FSR 16-14-08		
								.06	1,5	.10	2,5	2521	FSR 16-14-10		
								.10	2,5	.14	3,5	2550	FSR 16-14-14		
.17	4,2	.83	21,0	.79	20,0	.165	4,2	.03	0,8	.07	1,8	2522	FSR 17-17-07		
								.07	1,8	.11	2,8	2523	FSR 17-17-11		
								.11	2,9	.15	3,7	2524	FSR 17-17-15		
								.15	3,8	.19	4,8	2525	FSR 17-17-19		
.22	5,5	.56	14,2	.53	13,5	.122	3,1	.03	0,8	.07	1,8	2517	FSR 22-12-07		
								.07	1,8	.11	2,8	2518	FSR 22-12-11		
.24	6,0	.59	15,0	.55	14,0	.165	4,2	.02	0,6	.04	1,0	2500	FSR 24-17-04		
										.04	1,0	.08	2,0	2501	FSR 24-17-08
										.08	2,0	.12	3,1	2502	FSR 24-17-12
						.204	5,2	.03	0,8	.05	1,2	2506	FSR 24-21-05		
										.05	1,3	.09	2,3	2507	FSR 24-21-09
.24	6,0	.83	21,0	.79	20,0					.03	0,8	.07	1,8	2526	FSR 241-17-07
								.08	1,9	.11	2,8	2527	FSR 241-17-11		
								.11	2,9	.16	4,0	2528	FSR 241-17-16		
.31	8,0	.83	21,0	.79	20,0	.165	4,2	.01	0,3	.03	0,8	2575	FSR 31-17-03		
								.03	0,8	.08	2,0	2529	FSR 31-17-08		
								.08	2,1	.12	3,1	2530	FSR 31-17-12		
.35	9,0	.59	15,0	.55	14,0	.165	4,2	.04	1,0	.08	2,0	2532	FSR 35-17-08		
								.08	2,0	.12	3,1	2533	FSR 35-17-12		

Standard color black.

- Require only fingertip pressure for fast, easy installation.
- May be released from inside the panel.
- Multiple sizes range in height from .16" (4,0 mm) to .35" (9,0 mm).
- Part Description Key:
FSR XX-YY-ZZ where XX = Overall Height (inches), YY = Mounting Hole Diameter (inches) and ZZ = Maximum Panel Thickness (inches)

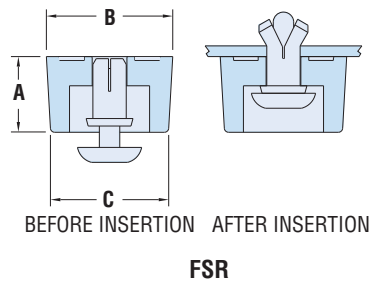

Material: Thermoplastic Rubber (TPR)
 Flammability Rating: 94-HB
 Temperature Range: -30°F (-34°C) to 250°F (121°C)

*Quick
Specs*



Heyco® Feet of Strength Feet with Snap-In Locking Fingers

- **Snap-in design** eliminates the installation labor needed for a screw or a rivet saving assembly time and equipment.
- Superior mounting approach as the Snap-In Bumper mounts securely into the panel while providing a strong mechanical support to the bumper when used as a mounting foot for electronic enclosures.
- Superior hold versus adhesive backed or screw/rivet bumpers.
- Designed to fit snugly into panel and is dust tight.
- Snap-In Bumpers are skid and scratch resistant and will not mark or stain surfaces.
- Lock firmly into enclosure.
- Quick and easy installation.
- Suitable for metal or plastic panels.
- Bumper constructed of EPDM rubber.
- Part Description Key: FSSI XX-YY-ZZ where XX = Overall Height (inches), YY = Mounting Hole Diameter (inches) and ZZ = Maximum Panel Thickness (inches)

PART DIMENSIONS				PANEL DIMENSIONS				PART NO. Black	DESCRIPTION		
A Overall Height		B Top Diameter		Mounting Hole Diameter	Thickness Range						
in.	mm.	in.	mm.		in.	mm.		in.	mm.		
FSSI Series											
.19	4,7	.812	20,6	.312	7,9	.03	0,8	.06	1,6	G3016	FSSI 19-31-06
.25	6,3	.812	20,6	.312	7,9	.03	0,8	.06	1,6	G3017	FSSI 25-31-06
.38	9,5	.812	20,6	.312	7,9	.03	0,8	.06	1,6	G3018	FSSI 38-31-06

Standard color black.

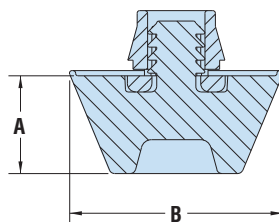

Snap-In

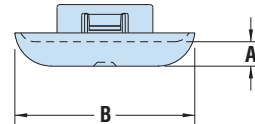

Low Profile Snap-In

Low Profile Feet with Snap-In Locking Fingers

- **The low profile snap-in design** requires no screws or adhesives to securely mount into a metal or plastic base.
- The TPE top provides a durable, non-skid surface.
- Snap-In Feet ensure a liquid tight seal and can be used for indoor or outdoor applications.
- Part Description Key: LTBP XXX-YYY where XXX = Mounting Hole Diameter (inches) and YYY = Maximum Panel Thickness (inches)



PART DIMENSIONS				PANEL DIMENSIONS				PART NO. Black	DESCRIPTION		
A Overall Height		B Top Diameter		Mounting Hole Diameter	Thickness Range						
in.	mm.	in.	mm.		in.	mm.		in.	mm.		
LTBP Series											
.13	3,2	.55	14,0	.500	12,7	.02	0,5	.06	1,6	C2008	LTBP 500-063
						.06	1,6	.25	6,4	C2058	LTBP 500-250
		.66	16,8	.625	15,9	.02	0,5	.06	1,6	C2012	LTBP 625-063
						.06	1,6	.25	6,4	C2062	LTBP 625-250
		.78	19,8	.750	19,1	.02	0,5	.06	1,6	C2016	LTBP 750-063
						.06	1,6	.25	6,4	C2066	LTBP 750-250
		.90	22,9	.875	22,2	.02	0,5	.06	1,6	C2020	LTBP 875-063
						.06	1,6	.25	6,4	C2070	LTBP 875-250
		1.05	26,7	1.000	25,4	.02	0,5	.06	1,6	C2022	LTBP 1000-063
						.06	1,6	.25	6,4	C2072	LTBP 1000-250
		1.16	29,5	1.093	27,8	.02	0,5	.06	1,6	C2024	LTBP 1093-063
						.06	1,6	.25	6,4	C2074	LTBP 1093-250

Standard color black.

Quick Specs

Material	FSSI Series: EPDM Rubber insert, Nylon 6/6 body LTBP Series: Nylon 6/6 and TPE co-molding
Flammability Rating	HB
Temperature Range	-40°F (-40°C) to 221°F (105°C)
IP Rating	IP 67/68 (LTBP only)

"Stay Connected" with



HEYware

a PennEngineering® Company



Heyco® Latches and Strikers

Latches

MOUNTING HOLE SIZE		PANEL THICKNESS		PART NO.	DESCRIPTION	PART DIMENSIONS						STRIKER Part No.
in.	mm.	in.	mm.			A Length		B Head Dia.		C Head Ht.		
				Natural		in.	mm.	in.	mm.	in.	mm.	
Round Mounting Hole Latch												
.354	9,0	.05 - .06	1,2 - 1,6	14300	DL-10F-N2W	.33	8,5	.43	10,8	.10	2,5	14304
Rectangular and Compound Mounting Hole Latches												
see schematic				14301	DL-009-POW	1.49	37,8	.51	13,0	.48	12,1	14305
.465 x .665	11,8 X 16,9	.04	1,0	14302	DL-20-W	.79	20,0	.73	18,5	.59	14,9	14306

- Latches and Strikers assemble together to keep a panel closed tightly.
- Design ensures an easy release when needed.

Standard color natural.

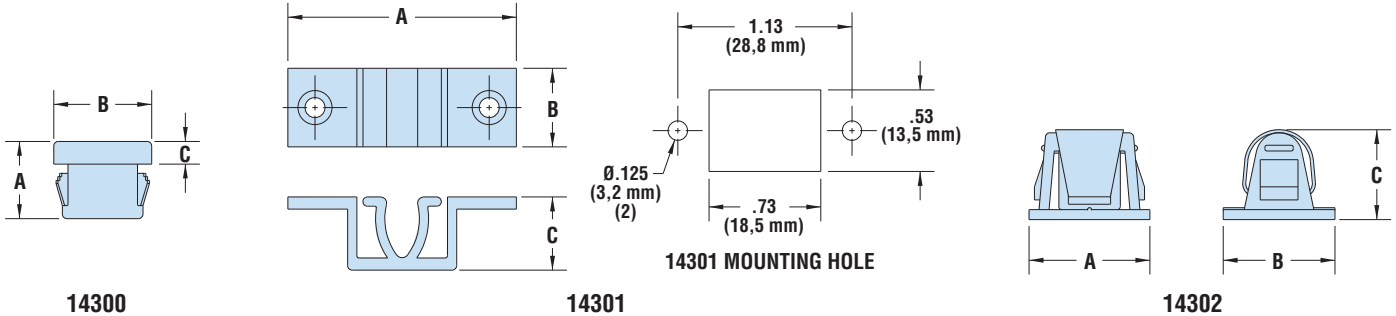

Strikers

MOUNTING HOLE(s) Diameter		Separation		PART NO.	DESCRIPTION	PART DIMENSIONS						Use with Latch Part No.
in.	mm.	in.	mm.			A Length		B Head Dia.		C Height		
				Natural		in.	mm.	in.	mm.	in.	mm.	
.122	3,1	.63	15,9	14304	DLS-10A-W	1.02	26,0	.59	15,0	.47	12,0	14300
.125	3,2	.71	18,0	14305	DLS-008-N2W	1.02	25,8	.51	13,0	.45	11,4	14301
.283 x .335	7,2 x 8,5	n/a		14306	DLS-20A-WA	.43	10,8	.43	11,0	.81	20,6	14302

Standard color natural.

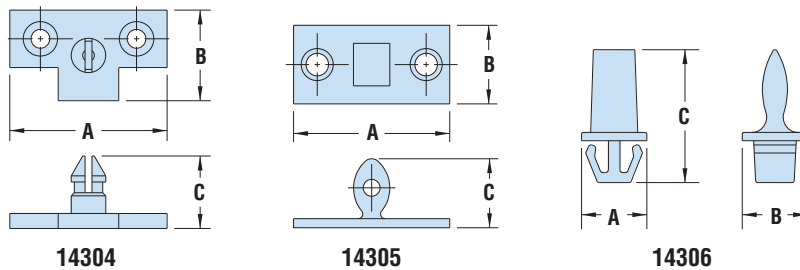

Material	Nylon 6/6
Flammability Rating	94V-2
Temperature Range	32°F (0°C) to 185°F (85°C)

Quick Specs

"Stay Connected" with



HEYware

a PennEngineering® Company



- Panels easily open when gently pushed in.
- Easy installation – snaps into hole in panel.
- Enables a single latch to accommodate multiple panel thicknesses.

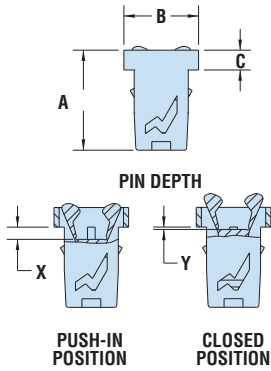

Heyco® Push Latches



MOUNTING HOLE Dimensions		PANEL THICKNESS		PART NO.		DESCRIPTION	Mating Pin	PIN DEPTH				PART DIMENSIONS					
in.	mm.	in.	mm.	Black	White			X Push-in	Y Closed	A Length	B Arm Spread	C Head Height	in.	mm.	in.	mm.	in.
.315 x .276	8,0 X 7,0	.08	2,0	14309		DPL-100A	1	.071	1,80	.014	0,35	.59	15,0	.43	11,0	.11	2,9
				14312		DPL-150F	2	.077	1,95	.020	0,50	.58	14,8	.43	11,0	.11	2,9
				14313		DPL-700F	2	.073	1,85	.020	0,50	.58	14,8	.43	11,0	.11	2,9
				14314		DPL-400P	3	.059	1,50	.016	0,40	.58	14,8	.43	11,0	.12	3,1

Standard color black

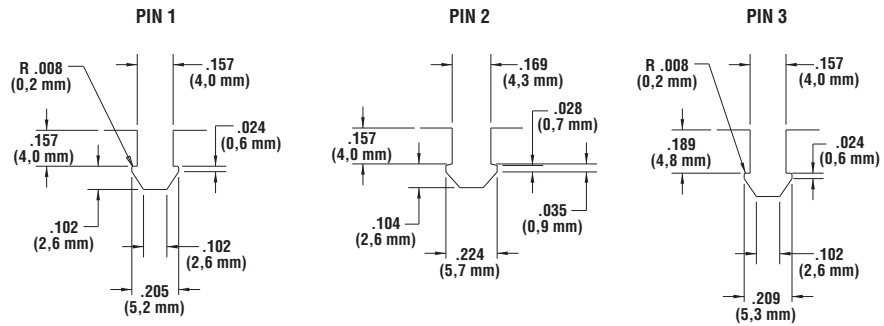

- Designed for fast and easy installation and removal - simply push to fasten and pull to release.
- Ideal for frequent maintenance work.
- Typical applications include metal enclosures, telecom equipment, appliances and electrical equipment.

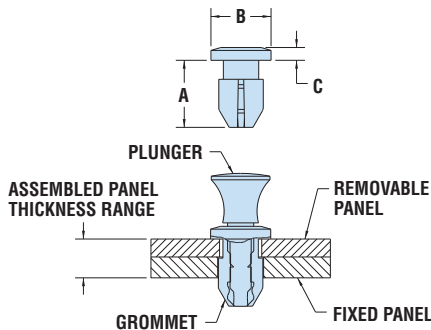

Heyco® Snap Latch Rivets



Grommet

FIXED PANEL HOLE DIAMETER	REMOVABLE PANEL THICKNESS	PART NO.		DESCRIPTION	MATING PLUNGER		PART DIMENSIONS						
		Black	White		Black	White	A Body Length	B Head Diameter	C Head Height	in.	mm.	in.	mm.
.253	.043	1,1	12283	12284	HSLG-1M	12261	12262	.31	8,0	.33	8,5	.07	1,8
	.063	1,6	12285	12286	HSLG-2M	12263	12264	.33	8,5	.33	8,5	.07	1,8
	.098	2,5	12287	12288	HSLG-3M	12265	12266	.37	9,5	.33	8,5	.07	1,8
	.161	4,1	12289	12290	HSLG-4M	12267	12268	.43	11,0	.33	8,5	.07	1,8

Standard colors black and white.

Plunger

REMOVABLE PANEL HOLE DIAMETER	ASSEMBLED PANEL THICKNESS RANGE	PART NO.		DESCRIPTION	MATING GROMMET	
		Black	White		Black	White
.237	1,5 - 1,6	12261	12262	HSLPB-1M	12283	12284
	2,0 - 2,1	12263	12264	HSLPB-2M	12285	12286
	3,0 - 3,1	12265	12266	HSLPB-3M	12287	12288
	4,6 - 4,7	12267	12268	HSLPB-4M	12289	12290

Standard colors black and white.

Material	Nylon 6/6
Flammability Rating	94V-2
Temperature Range	32°F (0°C) to 185°F (85°C)

Quick Specs

“Stay Connected” with



HEYware

a PennEngineering® Company

PCB Supports and LED Spacers LabKit #10

(Part No. 10999)



Use Heyco LabKits!

- Heyco LabKits are perfect for product design departments, experimental labs, and for all prototype work.
- The Heyco PCB Supports and LED Spacers LabKit #10 contains an assortment of our most popular PCB Supports and LED Spacers.
- Heyco also offers LabKits for Solar Power Components, Liquid Tight Cordgrips, Strain Relief Bushings, Hole Plugs, HEYware, and Grommets.
- Parts in LabKits are available in various sizes and colors. Please consult Heyco for further information.

Heyco® HEYware LabKit #5

(Part No. 3399)





8-1 Aluminum Solderless Connectors



8-1 Copper Lug Connectors



8-2 Copper & Aluminum Lay-In Connectors



8-2 Aluminum Neutral Bars



8-3 Wire Protector Terminal Blocks & Fixing Pin

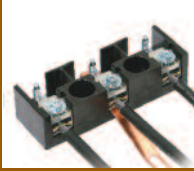

8-4 Post to Clamp Terminal Blocks



8-4 Barrier Terminal Blocks



8-5 Screw to (2) Tab Terminal Blocks



8-5 Aluminum Modular Splice Block

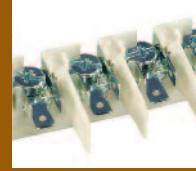

8-6 Screw to (3) Tabs Terminal Blocks



8-7 Wire Connectors - Crimp On



8-7 Wire Connectors - Color Coded



8-8 Quick Connect Terminals - .020 Male Tabs



8-9 & 8-10 Quick Connect Terminals - .032 Male Tabs



8-11 & 8-12 HEYConnect Terminal Bushings



8-13 Quick Connect Terminals - Females



8-14 Quick Connect Terminals - Flags



8-15 Heavy Duty Ring & Spade Terminals



8-16 Ring & Spade Terminals



8-17 Turn-2-Lock Contacts - 15 Amp



8-18 Turn-2-Lock Contacts - 20 Amp



8-19 Turn-2-Lock Contacts - 30 Amp



8-20 Nylon Premolds



8-21 Preassembled Cordset Components - Tri-Tap Premold



8-22 Preassembled Cordset Components - Female Bridge



8-23 Preassembled Cordset Components - Male Bridge



8-24 Preassembled Cordset Components - Padded Male Bridge



8-25 Preassembled Cordset Components - IEC 320



8-25 Business Machine Female Connectors



8-26 Business Machine Male Contacts

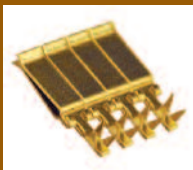

8-27 Heavy Duty Female Blade



8-27 & 8-28 Heavy Duty Male Blades



8-29 & 8-30 Padded Male Blades



8-31 & 8-32 Full Thickness Male Blades

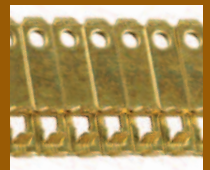

8-33 Full Thickness Male Blades - For Right Angle Plugs



8-33 Full Thickness Flat Plug Blades - For Low Profile Flat Plugs



8-34 Full Thickness Blades - BGB



8-34 Full Thickness Blades - BGMT



8-35 Hospital Grade Solid Male Blades



8-35 Hospital Grade U-Shape Ground Pin



8-36 Plug-In Device Contacts



8-37 Surface Mount Miniature Connectors



8-38 PCB Contacts



8-39 .187 Ground Pins - Male



8-40 .187 Ground Pins - Male Right Angle



8-41 .187 Ground Pins - Female



8-42 Specialty Pins - PCB, Electric Blanket & Medical



8-43 Heavy Duty Ground Pins - Male



8-44 Heavy Duty Ground Pins - Female



8-45 & 8-46 Male Pins



8-47 & 8-48 Female Pins



8-49 Specialty Female Connectors



8-50 Female Cord Connectors

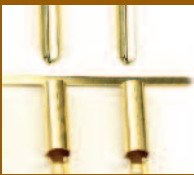

8-51 Male Pin Mating Chart



8-52 Multi-Connectors for Extension Cords - Cube Tap



8-52 Multi-Connectors for Extension Cords - Web foot



8-53 & 8-54 Multi-Connectors for Power Blocks



8-55 & 8-56 Male/Female Combination Terminals - 27 Gauge



8-57 Male/Female Combination Terminals - 20 Gauge



8-57 Combination Ground Pins

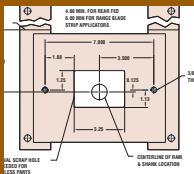

8-58 Applicator Ordering Guidelines & Press Specifications



8-59 Applicator Dies - Universal, Standard & Mini-Applicators



8-60 Semi-Automatic Applicator Systems



8-60 Wire Stripper

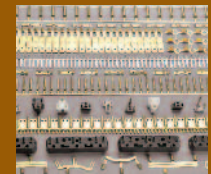

8-61 Heyco Stamping Capabilities



Solar Power Components
Part No. 3000



Liquid Tight Cordgrips
Part No. 3297



Strain Relief Bushings
Part No. 1999



Bushings
Part No. 2999

Check out our convenient LabKits!



Grommets
Part No. 2995



Hole Plugs
Part No. 2997



HEYware
Part No. 3399



PCB Supports & LED Spacers
Part No. 10999



“Stay Connected” with



Power Components

a PennEngineering® Company



- Compact design—lightweight yet strong.
- Electro-tin plated for low contact resistance and corrosion protection when used with copper conductors.
- Require no special installation tools.
- UL and CSA certified for use with copper and aluminum conductors.
- Ports are marked with catalog description and conductor range.
- DFARS Compliant

Heyco® Aluminum Solderless Connectors

WIRE RANGE (AWG)	PART NO.	DESCRIPTION	PART DIMENSIONS							
			A Width		B Length		C Height		Bolt Size	
			in.	mm.	in.	mm.	in.	mm.	in.	mm.
Single Conductor										
4-14	1863	A35	.50	12,7	1.06	26,9	.50	12,7		
2-14	1864	A90	.50	12,7	1.16	29,5	.56	14,2	1/4	6,4
1/0-14	1884	A125	.63	15,9	1.47	37,3	.78	19,8		
Two Conductors										
2-14	1864-2	A90-2	.91	23,0	1.16	29,5	.56	14,2	1/4	6,4
1/0-14	1884-2	A125-2	1.12	28,4	1.47	37,3	.78	19,8		

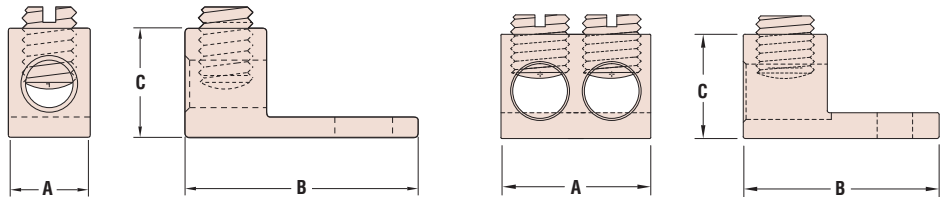

- 100% conductivity for highest efficiency.
- Completely reuseable.
- Require no special installation tools.
- UL listed and CSA certified for use with copper conductors.
- Marked with catalog description and conductor range.
- DFARS Compliant

Heyco® Copper Lug Connectors

Copper Single Hole Offset Lugs

WIRE RANGE (AWG)	PART NO.	DESCRIPTION	CURRENT RATING AMPS	HEIGHT WITH MAX. WIRE	PART DIMENSIONS						
					A Tang Width		B Length		Bolt Size		
				in.	mm.	in.	mm.	in.	mm.	in.	mm.
6-14	1851	CB 35	50	3/4	19,1	3/8	9,5	1-3/16	30,2	3/16	4,8

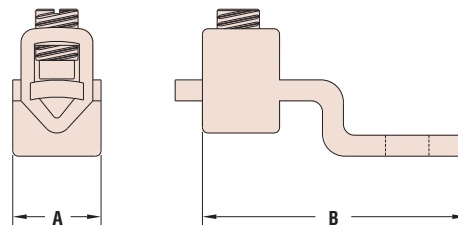

Quick Specs

Materials
Certifications

Flammability Rating

6061-T6 aluminum alloy; electrolytic copper
 UL Listed under Underwriters' Laboratories File E80121
 SP Certified by the Canadian Standards Association File 242954 & 246619
 94V-0

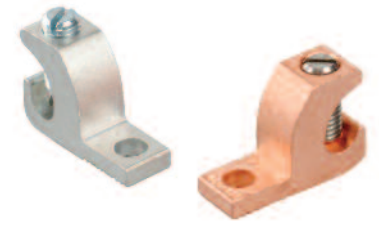

Heyco® Copper and Aluminum Lay-In Connectors

Wire Range AWG	PART NO.	DESCRIPTION	CONSTRUCTION	PART DIMENSIONS (in.)					
				A	B	C	D	F	H
4-14	S6525	LC 14-4 1-Pole Cu Tinned	Tinned Copper with Stainless Steel Set Screw	1.07	.75	.38	.22	.19	.15
	S6526	LC 14-4 1-Pole Cu	Copper with Stainless Steel Set Screw						
	S6527	LC 14-4 1-Pole Al	Aluminum with Steel Set Screw						

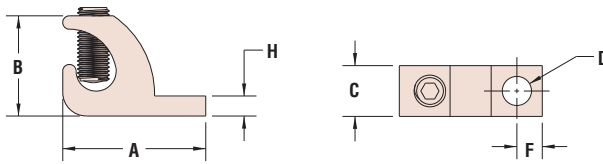

LCC and LCA Series

- Copper construction parts available in plated and unplated versions.
- Copper construction parts UL/CSA approved for direct burial and suitable for both indoor and out door use.
- Least expensive aluminum option suitable for indoor use only.
- **Recommended wire range AWG 4 thru AWG 14.**
- DFARS Compliant

Material Tinned copper or copper with stainless steel set screw; or High Strength, High Conductive Aluminum Alloy 6061T6 with steel set screw

Certifications Listed under Underwriters' Laboratories File E467246

Heyco® Aluminum Neutral Bars

WIRE RANGE AWG	CIRCUITS No.	MOUNTING HOLE(S)		LENGTH in.	PART NO.	DESCRIPTION	UL/CSA	PART DIMENSIONS (in.)				
		No.	Pos(s).					Width A	Height B	C	Pitch D	E
4-14 Cu or 4-12 Al	2	1	2	1.00	S6535	NB 14-4 2-Pole	CU9AL	.312	.437	.187	.312	.187
	3	2	1 & 5	1.63	S6536	NB 14-4 3-Pole						
	5	2	1 & 7	2.25	S6537	NB 14-4 5-Pole						
	6	1	4	2.25	S6538	NB 14-4 6-Pole						
		2	1 & 8	2.56	S6539							
	10	2	1 & 12	3.81	S6540	NB 14-4 10-Pole						
12	2	1 & 14	4.44	S6541	NB 14-4 12-Pole							

Other wire ranges, bar sizes, materials and configurations are available, consult Heyco

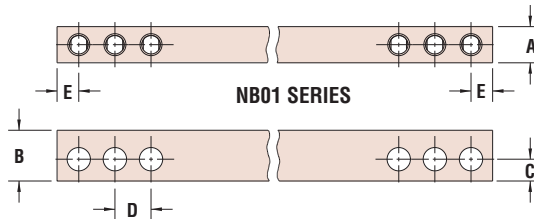

- Neutral bar for ground or power; *not* for power distribution.
- Rated at **85 Amps for Copper** wire and **70 Amps for Aluminum** wire.
- Wire range: AWG 4-14 CU (copper wire), 4-12 Al (aluminum wire) Dual Rated, Solid & Stranded, rigid or semi rigid stranding.
- Set screws are slotted, headless, zinc plated steel and will hold the smaller wires when the appropriate torque is fully applied.
- Use #10 mounting screw.
- DFARS Compliant

Materials Aluminum Neutral Bars
High strength tempered aluminum Alloy 6061, tin plated to resist oxidation and galvanic corrosion and with conductivity of approximately 43% IACS.
Zinc plated steel screws with trivalent (Cr+3) chromate conversion top layer.

Certifications UL Recognized Class ZMVB2.E80121 and CSA Certified File 8919

Quick
Specs

“Stay Connected” with



Power Components

a PennEngineering® Company



Heyco® Wire Protector Terminal Blocks

Screw to Screw—With Wire Protector Flap

- **Wire protector flap** allows the use of STRANDED or SOLID wire with no crimp terminals and no soldering required.
- Allows standardization of the SOLID WIRE Cordset. Input and output wires are always secured with a screw.
- Modern low profile design occupies less real estate.
- No exposed metal parts. “Dead front” designed safety.
- Pressure clamp connectors are supplied in the open position, ready to accept single or multiple solid conductors.
- All sizes are rated at 300 volts (450 volts in Europe).
- Metal parts feature galvanized steel screws and Ni or tin plated brass inserts.
- Available in 94V-0 flame retardant (FR), glass-filled 6/6 Nylon material.
- **Part No. 9299** fixing pin (below) can be used to mount all terminal blocks, with panel thickness limitations—consult Heyco.
- DFARS Compliant

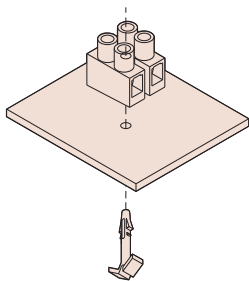

BODY STYLE	WIRE SIZE AWG	mm ²	AMPS North America	POLES	PART NO.		DESCRIPTION	Screws (Metric)	PART DIMENSIONS										
					Natural	FR White			A (12) Poles		B		C		D		E		F
								in.	mm.	in.	mm.	in.	mm.	in.	mm.	in.	mm.	in.	mm.

300 Volts Rated (450 Volts in Europe)

Low Profile	12-22	2,5	20	2	9389	9419	TB 0B-WP-2P	M 2,6	3,69	93,6	.64	16,2	.61	15,4	.11	2,8	.32	8,0	.11	2,8
					9393	N/A	TB 0B-WP-12P													
Raised Base	10-20	4	30	2	9394	N/A	TB 1B-WP-2P	M 3,0	4,58	116,4	.73	18,6	.67	17,0	.14	3,6	.39	10,0	.14	3,6
					9395	N/A	TB 1B-WP-3P													
				9426	N/A	TB 1B-WP-4P														
				9398	9428	TB 1B-WP-12P														
	8-14	6	50	3	9400	N/A	TB 2B-WP-3P	M 3,5	5,26	133,5	.87	22,2	.82	20,8	.17	4,2	.45	11,5	.15	3,7
9403					9433	TB 2B-WP-12P														

Standard color natural. Flame retardant white available at extra charge.

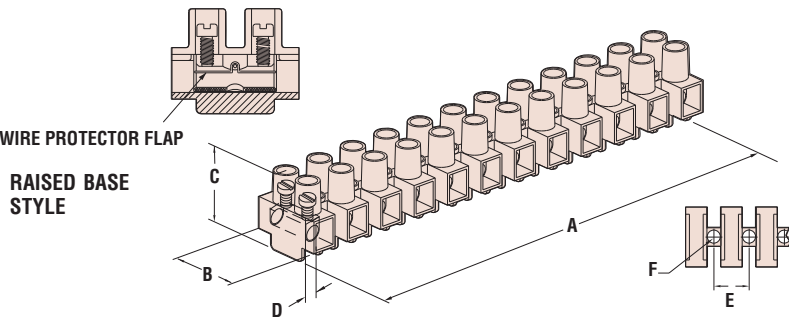
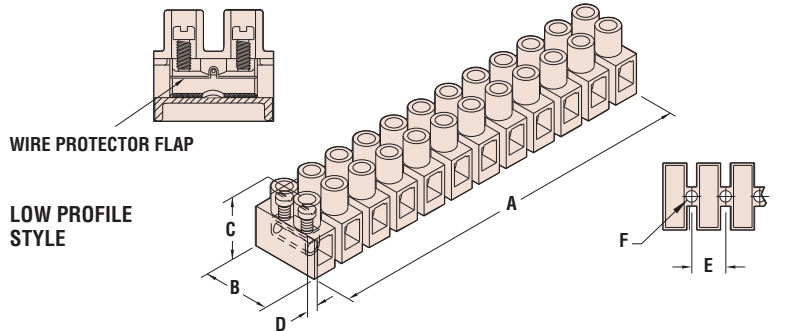

Quick
Specs

Materials
Certifications

6/6 Nylon and brass

Recognized under Component Program of Underwriters' Laboratories to both Canadian and US requirements File E197025

Approved

Flammability Rating
Temperature Range

94V-2

-40°F (-40°C) to 284°F (140°C)

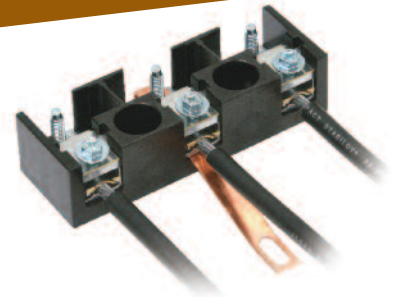

Heyco® Post to Clamp Terminal Blocks

For High Current Copper and Aluminum Wire Applications

PART NO.	DESCRIPTION	TERMINAL POST CONFIGURATION	A O.A. Length		B Block Depth		C O.A. Height		D O.A. Strap Length		E Mounting Hole		F Terminal Spacing	
			in.	mm.	in.	mm.	in.	mm.	in.	mm.	in.	mm.	in.	mm.
9460	ERTB-1A	OFFSET	3.38	85,9	1.63	41,4	1.03	26,2	2.88	73,2	1.19	30,2	1.19	30,2
9468	ERTB-2C	IN-LINE	3.95	100,3	1.35	34,3	1.12	28,4	2.88	73,2				
9469	ERTB-2D	IN-LINE	3.95	100,3	1.35	34,3	1.12	28,4	3.32	84,3	1.50	38,1	1.50	38,1

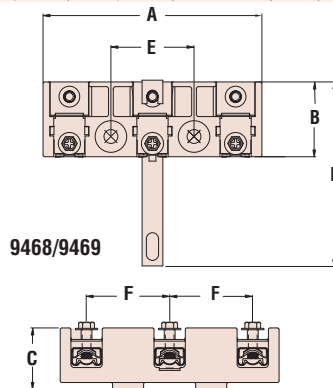
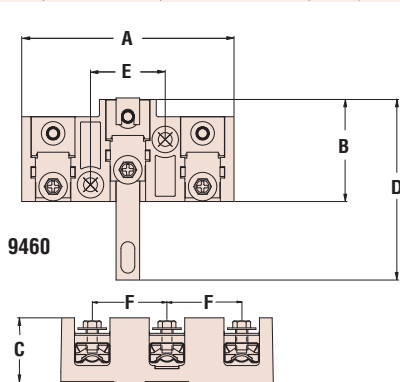

- All types rated at 300 volts 60 amps.
- Suitable for 6-4 AWG **aluminum** or 10-6 AWG copper stranded wire. 8 AWG and large compact conductor only for copper.
- Wire protector flap so that screw does not act directly upon wire, accepts and permits use of less expensive **aluminum** wire.
- Three pole terminal blocks, post to clamp style.
- Body molded of impact resistant polycarbonate.
- Solid copper grounding strap.
- Low installation torque - 35 lbs.
- DFARS Compliant

Flammability Rating 94V-0
 Certifications Recognized under the Component Program of Underwriters' Laboratories File E235481.
 Certified by the Canadian Standards Association, File 8919.
 Temperature Range -4°F (-18°C) to 257°F (125°C)



Heyco® Barrier Terminal Blocks

WIRE SIZE AWG	mm ²	AMPS		POLES*	PART NO.	DESCRIPTION	TERMINAL TAB CONFIGURATION	PART DIMENSIONS					
		North America	Europe					A		B		C	
								in.	mm.	in.	mm.	in.	mm.
12-22	4-1	20	16	1-100*	1757 1758	PA 80 F/F PA 81	3 tabs to 3 tabs end plate	1.142	29,0	1.50	38,0	.433	11,0

Standard color natural.
 *Poles may be ganged as required,
 1 each P/N 1757 for each pole connected.

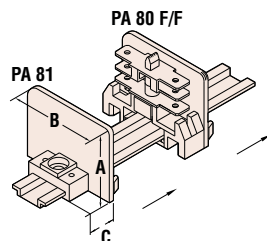

- **Single pole barrier terminal block**, whose inserts are ultrasonically welded into position.
- Each pole snap-fits into the next, enabling custom number of poles to suit your application.
- End plate PA 81 is required to effect an end barrier.
- Suitable for panel or 15 DIN 46277 rail mounting.
- All types are rated at 600 volts (380 volts in Europe).
- Made of Nylon and galvanized steel.
- DFARS Compliant

Materials Nylon and galvanized steel
 Certification Recognized Component under UL File E103541
 Flammability Rating 94V-0
 Temperature Range -40°F (-40°C) to 257°F (125°C)



- Affix to panel with No. 8 (M4) screws and nuts or use self tapping screws. An anti-rotation spigot is incorporated into the base.
- High working temperature capability.
- Available in **Standard** form for solid wire and **Wire Protector** form for stranded or solid wire.
- Two .250" by .031" (6,4 by 0,8 mm) tabs per pole.
- FV 77-2 poles are marked L and N.
- FV 77-3 poles are marked L,N and \ominus .
- FV77-4 poles are marked L1, L2, L3, and N.
- All sizes are rated at 600 volts (380 volts in Europe).
- DFARS Compliant

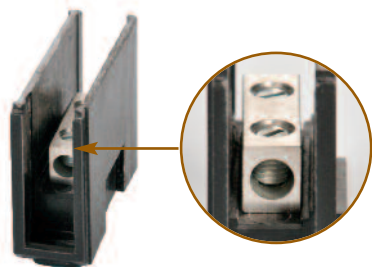

Heyco® Screw to Tab Terminal Blocks

Screw to (2) Tabs Flame Retardant and UL 94V-0

WIRE SIZE AWG	mm ²	AMPS		POLES	PART NO. Brown	DESCRIPTION	Screws (Metric)	PART DIMENSIONS							
		North America	Europe					A		B		C		D	
								in.	mm.	in.	mm.	in.	mm.	in.	mm.
Standard															
10-14	4	20	16	2	1554	FV 77-2	M 3,5 x 7	.984	25,0	1.043	26,5	.846	21,5	N/A	N/A
10-14	4	20	16	3	1556	FV 77-3	M 3,5 x 7	1.614	41,0	1.043	26,5	.846	21,5	.550	14,0
				4	1558	FV 77-4	M 3,5 x 7	2.244	57,0						
With Wire Protector Flap															
10-14	4	20	16	2	1555	FV 77-2 WP	M 3,5 x 7	.984	25,0	1.043	26,5	.846	21,5	N/A	N/A
10-14	4	20	16	3	1557	FV 77-3 WP	M 3,5 x 7	1.614	41,0	1.043	26,5	.846	21,5	.550	14,0
				4	1559	FV 77-4 WP	M 3,5 x 7	2.244	57,0						

Standard color flame retardant brown.

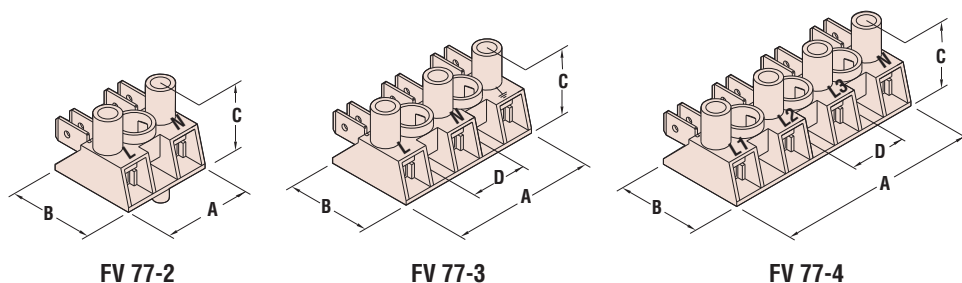

Heyco® Aluminum Modular Splice Block

Single Splice for 115 to 175 Amps

LINE SIDE AWG	LOAD SIDE AWG	PART NO.	DESCRIPTION	AMPS per Pole	INSULATOR BLOCK		
					Length A	Width B	Height C
2 - 14	2 - 14	S6530	MSS 14-2 1-Pole	115	2.90	1.04	2.34

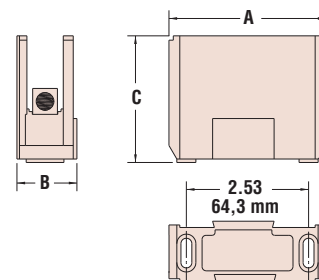

- The Modular Splice Block is a **modular, interlocking power splicing block**.
- Simply slip on and lock into place the number of poles needed for your application. Modular design reduces stocking requirements.
- Made of tin plated aluminum in order to provide reliable connectors for copper or aluminum wires.
- Rated for 600 Volts.
- DFARS Compliant

Screw-to-Tab Terminal Blocks
6/6 Nylon and galvanized steel

Materials

Certifications



Recognized Component under UL File E103541



Certified by the Canadian Standards Association File 88539

Flammability Rating

94V-0

Temperature Range

-4°F (-18°C) to 302°F (150°C)

Aluminum Modular Splice Block

Glass-filled polyester insulator block and high strength tempered Aluminum Alloy 6061, tin plated to resist oxidation and galvanic corrosion, and with conductivity of approximately 43% IACS. Zinc plated steel screws with trivalent (Cr+3) chromate top layer.



Recognized Component under Underwriters' Laboratories File E197025



Certified by the Canadian Standards Association File 8919



Heyco® Screw to Tab Terminal Blocks

Screw to (3) Tabs Flame Retardant and UL 94V-0

WIRE SIZE AWG	mm ²	AMPS	POLES	PART NO. White	DESCRIPTION	Screws (Metric)	PART DIMENSIONS											
							A		B		C		D		E		F	
								in.	mm.	in.	mm.	in.	mm.	in.	mm.	in.	mm.	
8-18	10	40	3	9450	ATB-3P FR	M5,0	3.19	81,0	.59	15,0	1,00	25,4	2,60	66,0	.41	10,4	1,48	37,5
				9451	ATB-3P FR w/ Ground													
8-18	10	40	4	9452	ATB-4P FR	M5,0	3.90	99,0	.59	15,0	1,00	25,4	3,31	84,0	.41	10,4	1,48	37,5
				9454*	ATB-6P FR													
8-18	10	40	6	9455*	ATB-6P FR w/ Ground	M5,0	5.31	135,0	.59	15,0	1,00	25,4	4,72	120,0	.41	10,4	1,48	37,5
				9456	Jumper for Screw to Tab Poles													
				9457	Ground for Screw to Tab TB													

Standard color flame retardant white.

*Includes three jumpers. To order additional jumpers, see part 9456.

- Three .250" by .031" (6,3 by 0,8 mm) tabs per pole.
- ATB-3P poles are marked 1, 2, and ⊕.
- ATB-4P poles are marked 1, 2, 3 and ⊕.
- ATB-6P poles are marked 1, 2, 3, 4, 5 and ⊕.
- All sizes are rated at 600 volts (450 volts in Europe).
- Self-grounding version is available. Identical to the base parts except that an extension on the grounding pole makes direct contact with the panel. The extension is secured with two self-tapping screws.
- Ground contact (**Part No. 9457**)— Grounds terminal block to the panel. May be ordered separately or with the listed Appliance Terminal Blocks.
- Jumper (**Part No. 9456**)— To connect terminal block poles. For use with Heyco's Screw to Tab terminal blocks.
- DFARS Compliant

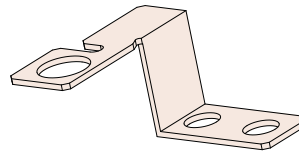
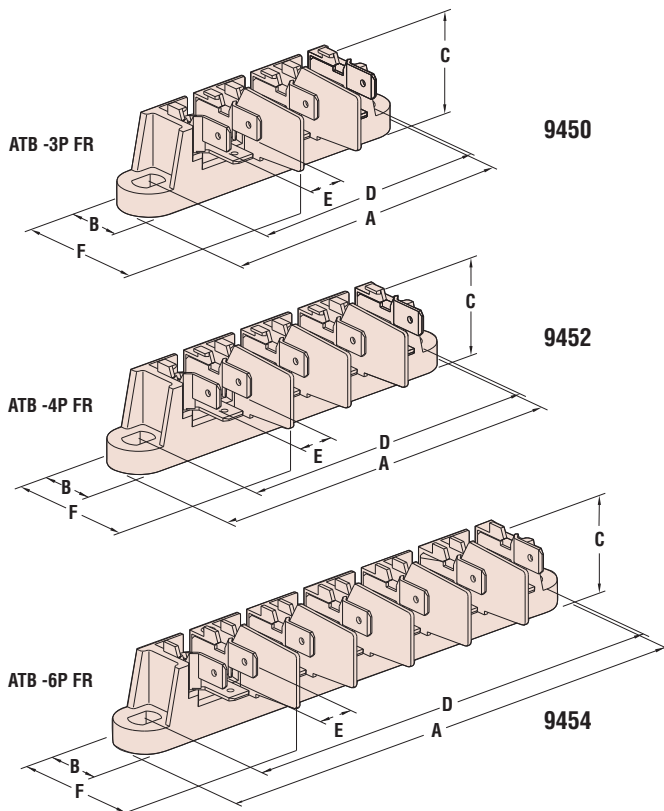

9457
GROUND CONTACT

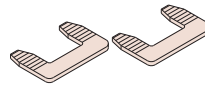

9456
JUMPER

Materials
Certifications

6/6 Nylon and galvanized steel
 Recognized under Component Program of Underwriters' Laboratories to both Canadian and US requirements File E197025

Flammability Rating
Temperature Range

94V-0
-4°F (-18°C) TO 302°F (150°C)

Quick
Specs



- Quick, permanent and secure installation with recommended crimp tool.
- Five sizes for #10 AWG thru #22 AWG.
- UL rated at 600 volts except as noted.
- Closed-end nylon shell with plated copper internal sleeve.

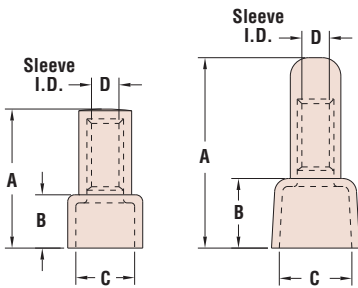

Part No. 2988**
Features Extra Clearance Beyond Sleeve.



- Gray, Blue, Orange, Yellow, and Red colors for easy size and capacity identification.
- Square wire spring insert bites into and securely connects #10 AWG thru #22 AWG.
- Fluted body for easy assembly.
- 81-G and 82-B UL rated 300 volts. 83-0 and 84-Y UL rated at 600 volts.

Heyco® Wire Connectors

WIRE COMBINATIONS (AWG)	PART NO.	DESCRIPTION	USE CRIMP TOOL	PART DIMENSIONS							
				A		B		C		D	
				in.	mm.	in.	mm.	in.	mm.	in.	mm.

Crimp-On

JOINS: 1#16 & 1#20 Thru 2-5#22	2986	1622N	0992 (YS-7)	.60	15,2	.23	5,9	.24	6,2	.09	2,4
JOINS: 1#14 & 1#18 Thru 2-7#22	2988**	1422DN	0992 (YS-7)	.79	20,1	.31	7,9	.32	8,1	.12	3,0
JOINS: 1#14 & 1#18 Thru 2-7#22	2990	1422N	0992 (YS-7)	.60	15,2	.23	5,9	.26	6,5		
JOINS:* 1#10 & 1#14 Thru 4#20	2992	1022N	0992 (YS-7)	.70	17,1	.32	8,0	.37	9,4	.16	4,0
JOINS:* 1#10&1#12 Thru 4#16	2994	1020N	n/a	.87	22,2	.40	10,2	.47	12,0	.20	5,1

Color Coded

Color

JOINS #22 Thru #14 Min. 3#22 Max. 2#16	2937	81-G	Gray	.57	14,5	.33	8,4				
JOINS #22 Thru #14 Min. 3#20 Max. 3#16	2940	82-B	Blue	.70	17,8	.39	9,9				
JOINS #22 Thru #14 Min. 2#18 Max. 2#14	2949	83-0	Orange	.84	21,3	.45	11,4				
JOINS #22 Thru #10 Min. 3#20 Max. 2#12	2952	84-Y	Yellow	.94	23,9	.54	13,7				
JOINS #20 Thru #8 Min. 2#14 Max. 4#12	2955	86-R	Red	1.05	26,7	.64	16,3				

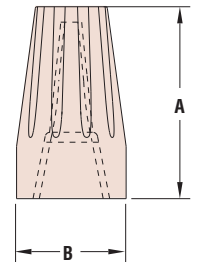

*Only suitable for stranded #10 AWG (6,0 mm) wire.

**Extra clearance beyond sleeve.

Quick Specs

Materials	Crimp-On – Nylon 6/6 and brass	Color Coded – Polypropylene and steel
Certifications	UL Listed under Underwriters' Laboratories File E80121	CS Certified by the Canadian Standards Association File 211101 (Color Coded only)
Flammability Rating	Crimp-On – 94V-0	Color Coded – 94V-2
Temperature Range	-4°F (-18°C) to 221°F (105°C)	

Heyco® Quick Connect Terminals

See pages 8-13 & 8-14 for mating Quick Connect Females.
For Heyco Applicators, see page 8-59

Male Terminal Tabs - .020 gauge



Crimp?	Ref Dwg	PART DATA			PART NO.	APPLICATION TOOLING*				
		Overall Length in.	AWG Range	Material		Die**	Feeds	Crimp Punch	Anvil	
Solder Connection Tabs										
No	4700	.61	Solder	Brass Tin-Pl	4700 4701	-	Bulk	-	-	-
Crimp Connection Tabs										
Yes	4710	.61	18	Brass	4710	-	Bulk	-	-	-
				Brass Tin-Pl	4750 4751	4750UXX5 4751UXX5	Left to Right	C458	C463	
	8301	.61	18	Brass	8301	8301UXX5	Right to Left	C460	C465	-
Dual Connection Tabs										
No	4720	.69	Dual	Brass Tin-Pl	4720 4721	-	Bulk	-	-	-

- All terminals feature a **rectangular “locking tab”** in center for added **strain relief** and **support** when inserted into Female Connector.
- Heyco Terminals meet all your application needs with **solder**, **crimp**, and **dual male** connections.
- DFARS Compliant

* Heyco high volume Application Tooling, designed for 3-5 ton presses - see page 8-59.
Heyco Mini Applicators, designed for 1.5-3 ton bench top presses, are available for Part Nos. 4750 and 4751 only. See page 8-59.

** “XX” represents Wire Gauge. Please specify Wire Gauge when ordering.

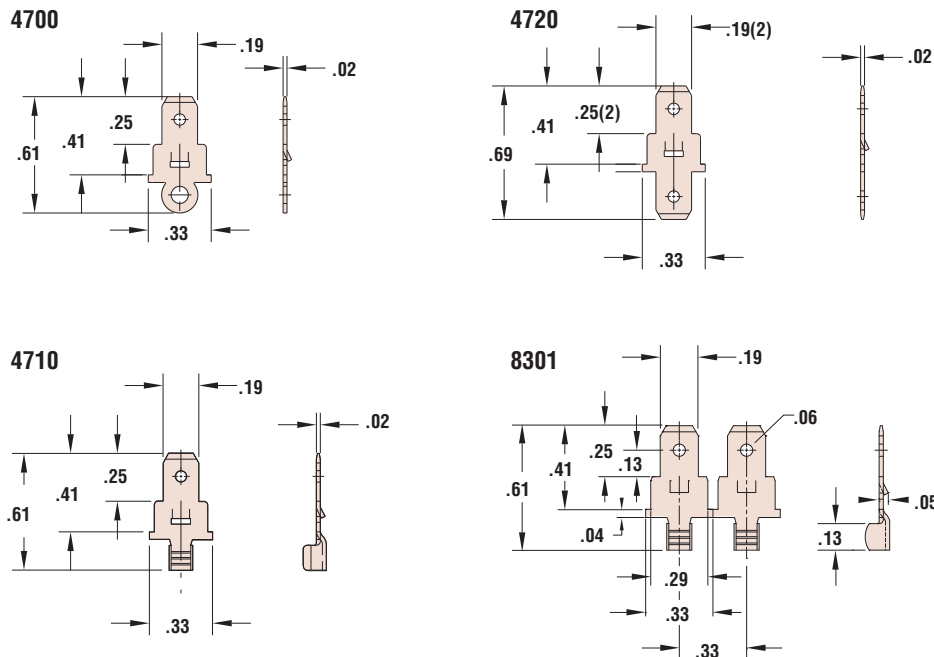

Materials

Alloy 260 Brass (70% Cu, 30% Zn. Higher Cu content resists dezincification)
Tin-Pl = Brass, Tin plated before or after stamping

Quick
Specs



Heyco® Quick Connect Terminals

See pages 8-13 & 8-14 for mating Quick Connect Females.

For Heyco Applicators, see page 8-59

Male Terminal Tabs - .032 gauge

- All terminals feature a **rectangular “locking tab”** in center for added **strain relief** and **support** when inserted into Female connector.
- Heyco Terminals meet all your application needs with **solder**, **crimp**, and **dual male** connections.
- For schematic drawings see opposite page.
- DFARS Compliant

Crimp?	Ref Dwg	PART DATA			PART NO.	APPLICATION TOOLING*				
		Overall Length in.	AWG Range	Material		Die**	Feeds	Crimp Punch	Anvil	
Solder Connection Tabs										
No	4810	.65	Short Solder	Brass Tin-Pl	4810 4811	-	Bulk	-	-	
	4833	.72	Solder	Brass	4833	-	Right to Left	-	-	
	8211	.73	Solder	Brass	8211	-	Bulk	-	-	
	4800	.81	Solder	Brass Tin-Pl	4800 4801	-	Bulk	-	-	
Yes†	8044	1.12	Solder	Brass	8044	-	Bulk	-	-	
	8040	1.61	Solder	Brass	8040	-	Bulk	-	-	
Crimp Connection Tabs										
Yes	4836	.64	90° Angle Crimp 18-16	Brass	4836	0624	Right to Left	OK24	OK25	
	4838	.71	26-18	Brass	4838	4838UXX5	Left to Right	C458	C463	
	4820	.81	18-16	Brass Tin-Pl	4820 4821	-	Bulk	-	-	
Brass Tin-Pl				4834 4835	4834UXX5 4835UXX6	Left to Right	C460	C465		
Dual Connection Tabs										
No	4822	.47	60° Angle Tab-Dual	Tin-Pl	4822	-	Bulk	-	-	
	4830	.83	Dual	Brass Tin-Pl	4830 4829	-	Bulk	-	-	

* Heyco high volume Application Tooling, designed for 3-5 ton presses - see page 8-59.
Heyco Mini Applicators, designed for 1.5-3 ton bench top presses, are available for Part Nos. 4834, 4835 & 4848 only. See page 8-59.

** “XX” represents Wire Gauge. Please specify Wire Gauge when ordering.

† Hook crimp located at the quick connect tab end of Terminal

Quick Specs

Materials

Alloy 260 Brass (70% Cu, 30% Zn. Higher Cu content resists dezincification)

Tin-Pl = Brass, Tin plated before or after stamping

Heyco® Quick Connect Terminals

Male Terminal Tabs - .032 gauge – Schematic Drawings

Solder Connection Tabs

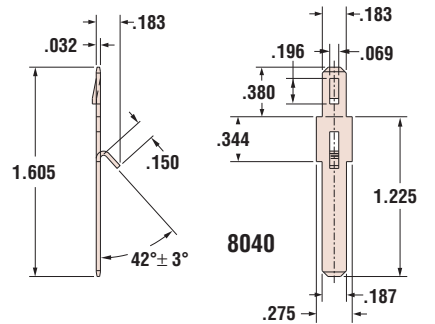
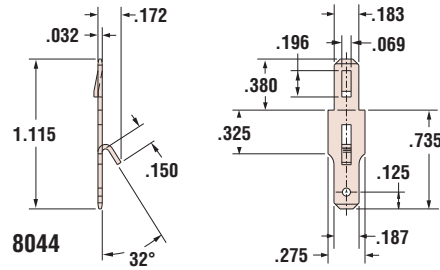
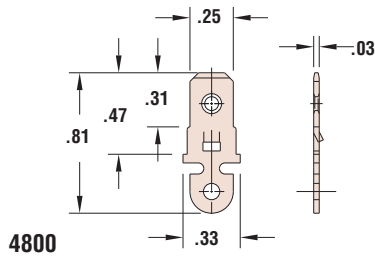
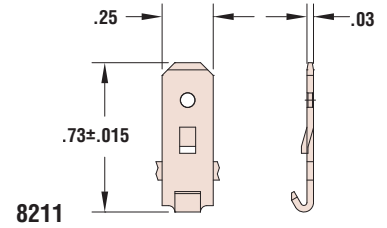
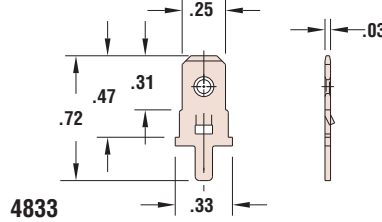
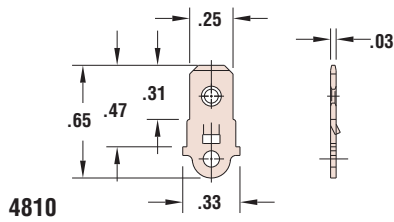

Crimp Connection Tabs

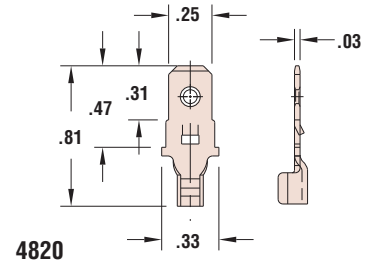
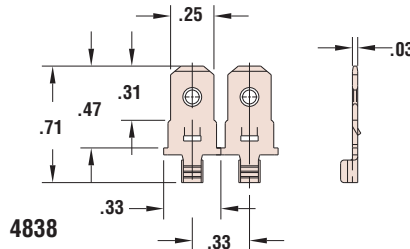
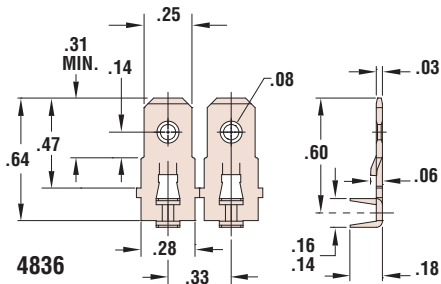

Dual Connection Tabs

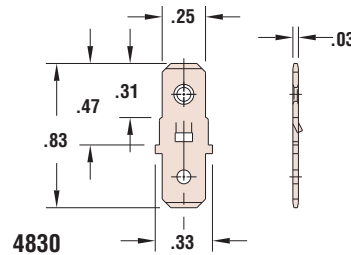
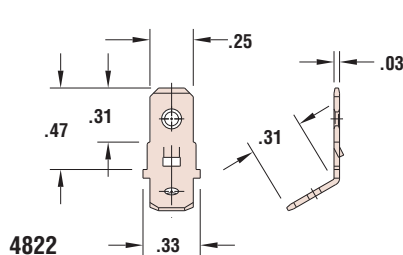

Materials

Alloy 260 Brass (70% Cu, 30% Zn. Higher Cu content resists dezincification)

Tin-Pl = Brass, Tin plated before or after stamping

*Quick
Specs*



HEYConnect™ Terminal Bushings

Bushings with Double Male Terminals

- Small, snap-in nylon receptacles for low cost, insulated, quick connection or disconnection of your wires, through panels, housings or detachable shrouds.
- Typical uses are data processing and vending machines, motors, power supplies, and controls.
- Non-polarized HEYConnects feature 1/4" (6,4 mm) internal brass male terminals, to mate with standard 1/4" (6,4mm) female Quick-Connects.
- Polarized HEYConnects feature 1/4" (6,4 mm) and 3/16" (4,7 mm) internal brass male terminals, to mate with standard 1/4" and 3/16" female Quick-Connects.
- Two-terminal HEYConnect bodies feature markings that correlate the terminals, front to back.
- Available in double-male and male-solder configurations.
- Rated for 300 Vac/Vdc @ 8.2 Amps.
- See schematics on page 8-12.
- DFARS Compliant

TERMINALS			PANEL DIMENSIONS						PART NO.	DESCRIPTION	PART DIM.	
No. of Poles	Width		A Mounting Hole Diameter		B To Prevent Rotation		C Maximum Panel Thickness				Black	D Overall Length
	in.	mm.	in.	mm.	in.	mm.	in.	mm.				
Non-polarized												
1	.25	6,4	.500	12,7	.465	11,8	.125	3,2	4240	DC 50-1-M/M	.94	23,9
									4250	DC 50-1-M/M Tinned		
1	.25	6,4	.687	17,4	.640	16,3	.125	3,2	4380	DC 68-1-M/M	.94	23,9
2	.25	6,4	.687	17,4	.640	16,3	.125	3,2	4440	DC 68-2-M/M		
Polarized												
1	.19	4,8	.687	17,4	.640	16,3	.125	3,2	4428	DC 68-2-M/M Polarized	.94	23,9
1	.25	6,4										

Bushings with Tinned Male to Solder Terminals

TERMINALS			PANEL DIMENSIONS						PART NO.	DESCRIPTION	PART DIM.	
No. of Poles	Width		A Mounting Hole Diameter		B To Prevent Rotation		C Maximum Panel Thickness				Black	D Overall Length
	in.	mm.	in.	mm.	in.	mm.	in.	mm.				
Non-polarized												
1	.25	6,4	.500	12,7	.465	11,8	.125	3,2	4270	DC 50-1-M/S-Tinned	.92	23,4
1	.25	6,4	.687	17,4	.640	16,3	.125	3,2	4410	DC 68-1-M/S-Tinned	.92	23,4
2	.25	6,4	.687	17,4	.640	16,3	.125	3,2	4470	DC 68-2-M/S-Tinned		
Polarized												
1	.19	4,8	.687	17,4	.640	16,3	.125	3,2	4468	DC 68-2-M/S-Pol Tinned	.92	23,4
1	.25	6,4										

Standard color black. Consult Heyco for white and other colors.



Quick
Specs

Material
Certifications

Polycarbonate
 Recognized under the Component Program of Underwriters' Laboratories File E467283 to both Canadian and US Requirements

Flammability Rating
Temperature Range

94V-0
32°F (0°C) to 266°F (130°C)

HEYConnect™ Terminal Bushings - Schematics

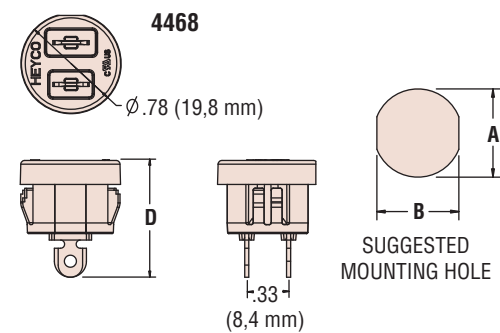
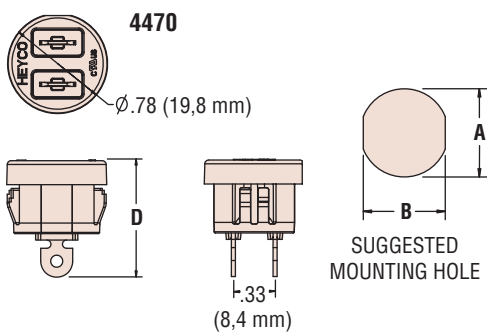
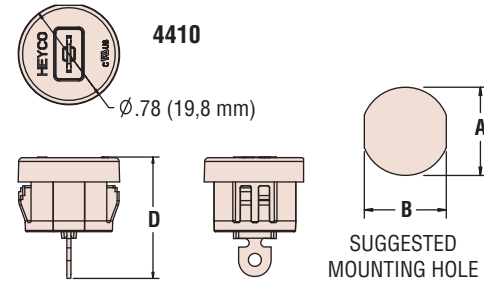
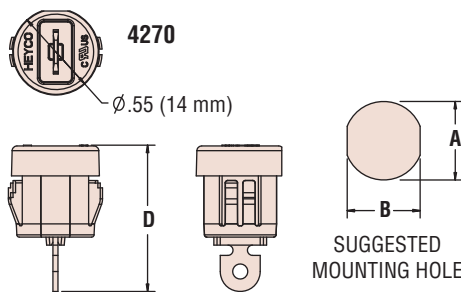
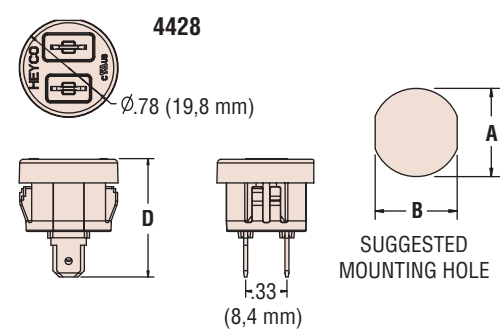
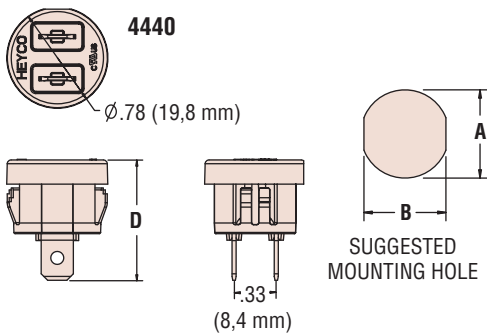
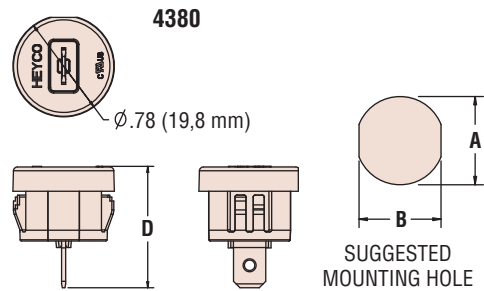
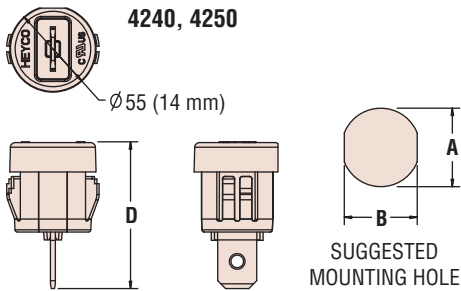



Heyco® Quick Connect Terminals

See pages 8-8 & 8-9 for mating Quick Connect Male Tabs.
For Heyco Applicators, see page 8-59

Female Terminals

- Quick Connects allow you to easily choose the right terminals for your application.
- **Insulation Support Terminals** provide **strain relief** as well as **support** for insertion into the housing, allowing the terminal to withstand shock and vibration.
- **Low Insertion Force and Non-Insulation Support Terminals** provide ease of assembly onto the Male Tab as well as a **Heyco patented lance tab** for better contact and stronger hold on the Male Tab.
- Can be applied with your existing equipment or with Heyco Applicators.
- These applicators offer reliable connections semi-automatically and by integration into automated termination.
- Field Tested.
- Available in brass and pre-tinned brass.
- Most popular configurations available.
- .110" straight
- .187" straight
- .250" straight
- .010", .0160", and .0180" gauge material.
- Available in strip form only except Part No. 7954: bulk.
- Consult Heyco for many additional terminal options not listed here.
- DFARS Compliant

Stock Gauge in.	Insulation Dia. in.	PART DATA			PART NO.	FEED	PART DIMENSIONS		
		Mating Tab Size in.	AWG Range	Material			W in.	L in.	D in.
Insulation Support Terminals									
.010	.060/.100	.110 x .020	22-18	Brass Tin-Pl	7940 7941	Traverse	.148	.64	.25
		.110 x .032	22-18	Brass Tin-Pl	7942 7943				
.016	.090/.130	.187 x .020	18-16	Brass Tin-Pl	7932 7933	Traverse	.232	.59	.25
		.187 x .032	18-16	Brass Tin-Pl	7930 7931				
.016	.120/.170	.250 x .032	18-14	Brass Tin-Pl	7920 7921	Traverse	.296	.75	.30
.018	.120/.170	.250 x .032	18-14	Tin-Pl	7923				
Insulation Support Terminals - Low Insertion Force									
.016	.120/.170	.250 x .032	18-14	Brass Tin-Pl	7924 7925	Traverse	.300	.75	.30
Non-Insulation Support Terminals									
.010	-	.110 x .020	16-12	Brass	7946	Traverse	.148	.70	.25
.016	-	.250	Solder	Brass	7954	Bulk	.300	.57	.30

Insulation Support Terminals

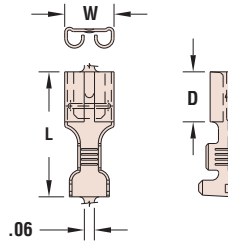

Non-Insulation Support Terminals (Solder)

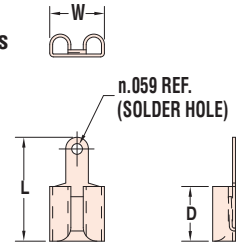

Insulation Support Terminals-LIF

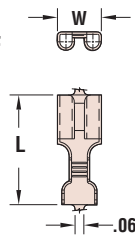

Non-Insulation Support Terminals (Crimp)

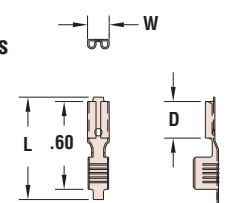

Quick Specs

Materials Alloy 260 Brass (70% Cu, 30% Zn. Higher Cu content resists dezincification)
Tin-Pl = Brass, Tin plated before or after stamping

Certifications Listed under Underwriters' Laboratories File E137778
 Certified by the Canadian Standards Association File 97795

Heyco® Quick Connect Terminals

See pages 8-8 & 8-9 for mating Quick Connect Male Tabs.
For Heyco Applicators, see page 8-59

Flag Terminals

Stock Gauge in.	Insulation Dia. in.	PART DATA			PART NO.	FEED	PART DIMENSIONS		
		Mating Tab Size in.	AWG Range	Material			W in.	L in.	D in.
Flag Insulation Support Terminals									
.016	.110/.160	.250 x .032	18-14	Brass	7950	Traverse	.300	.48	.24
				Tin-Pl	7951				
				Tin-Pl	7953*				
Flag Terminals									
.010	-	.110 x .020	24-18	Brass	7910	Traverse	.148	.31	.15
				Tin-Pl	7911				

* Left-handed Flag.



- Quick Connects allow you to easily choose the right terminals for your application.
- **Flag Insulation Support Terminals** provide **strain relief** as well as **support** for insertion into the housing, allowing the terminal to withstand shock and vibration.
- Can be applied with your existing equipment or with Heyco Applicators.
- These applicators offer reliable connections semi-automatically and by integration into automated termination.
- Field Tested.
- Available in brass and tin-plated brass.
- .016" and .010" gauge material.
- Available in strip form only.
- DFARS Compliant

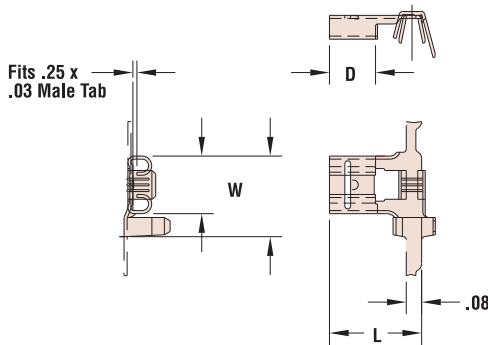

Flag Insulation Support Terminals

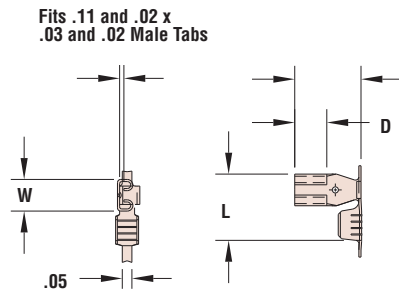

Flag Terminals

Materials	Alloy 260 Brass (70% Cu, 30% Zn. Higher Cu content resists dezincification) Tin-Pl = Brass, Tin plated before or after stamping
Certifications	Listed under Underwriters' Laboratories File E137778 Certified by the Canadian Standards Association File 97795

Quick
Specs

Heyco® Heavy Duty Ring and Spade Terminals

For Heyco Applicators, see page 8-59

- **Three up** and **two up** applicators allow operators to attach multiple terminals at once.
- .0315" and .040" gauge material.
- Available in strip form only.
- HD Spade features **90° bend** to lock screw in place.
- DFARS Compliant

Insulation Crimp?	PART DATA			PART NO.	APPLICATION TOOLING *					
	Hole Dia. in.	AWG Range	Material		Die **	Feed	Parts per Feed	Crimp Punch	Anvil	
Heavy Duty Ring Terminals										
No	.265	12-8	Brass	6072 6073	6072SXX5 6073SXX5	Rear Rear	3 2	0W29, 0W46, 0W48	0W28, 0W45, 0W47	
No	.265	8-6	Brass	6070 6071	6070SXX5 6071SXX5	Rear Rear	3 2	0W29, 0W49	0W28	
Heavy Duty Spade Terminals										
No	.265	12-8	Brass	6082 6083	6082SXX5 6083SXX5	Rear Rear	3 2	0W29, 0W46, 0W48	0W28, 0W45, 0W47	
No	.265	8-6	Brass	6080 6081	6080SXX5 6081SXX5	Rear Rear	3 2	0W29, 0W49	0W28	

* Use the Heyco Standard Applicator Die (indicated by "S" in the Die Part No.), page 8-59.

** "XX" represents Wire Gauge. Please specify Wire Gauge when ordering.

HD Ring

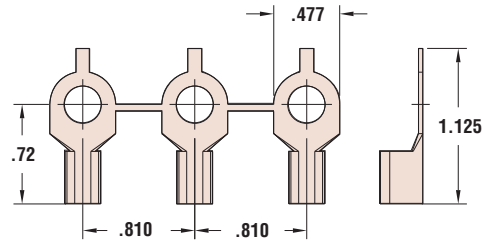

HD Spade

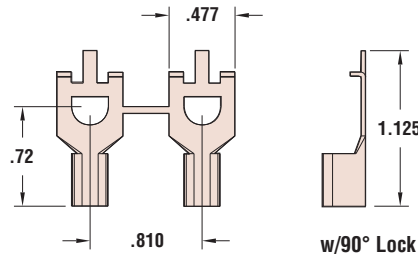

Quick Specs

Material
Certifications

Alloy 260 Brass (70% Cu, 30% Zn. Higher Cu content resists dezincification)
 Listed under Underwriters' Laboratories File E95474

“Stay Connected” with



Power Components

a PennEngineering® Company



Heyco® Ring and Spade Terminals

For Heyco Applicators, see page 8-59

Insulation Crimp?	PART DATA			PART NO.	APPLICATION TOOLING*				
	Hole Size	AWG Range	Material		Die**	Feeds	Tool Packs	Crimp Punch	Anvil
Ring Terminals									
Yes	#6	20-14	Brass Tin-Pl	8121 8120	8121UXX5 8120UXX5	Left to Right	B810L/B811L	C152	C157
	#8	20-14	Brass Tin-Pl	8123 8122	8123UXX5 8122UXX5				
	#10	20-14	Brass Tin-Pl	8125 8124	8125UXX5 8124UXX5				
No	#6	20-14	Brass	8131	8131UXX5	Left to Right	B810L/B811L	C152	C157
	#8	20-14	Brass Tin-Pl	8133 8132	8133UXX5 8132UXX5				
	#10	20-14	Brass	8135	8135UXX5				
No	#10 (.180)	16-12	Brass	8139†	8139UXX5	Left to Right	B982L/B983L	C908	C909
	#10 (.197)	16-12	Brass	8145† 8147††	8145UXX5 8147UXX5				
	.265	16-12	Tin-Pl	8146	8146UXX5				

Spade Terminals

No	#6	24-18 18-14	Brass Brass	8100† 8110	8100UXX5 8110UXX5	Left to Right	B800L/B801L	C064	C070
	#6 w/lock	18-14	Brass	8140	-				
No	#10	16-12	Brass	8144†	8144UXX5	Left to Right	B982L/B983L	C908	C909

* Heyco high volume Application Tooling, designed for 3-5 ton presses - see page 8-59.

Heyco Mini Applicators, designed for 1.5-3 ton bench top presses, are available - see page 8-59.

** “XX” represents Wire Gauge. Please specify Wire Gauge when ordering.

† Not UL Listed.

†† Larger crimp than 8145; not UL Listed.

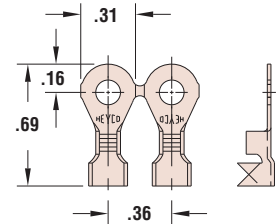

Ring 20-14 AWG w/Ins. Crimp

- Insulation Support Terminals provide strain relief and wire support for vibration resistance.
- DFARS Compliant

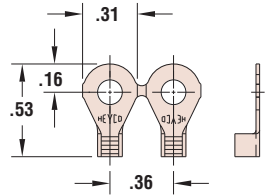

Ring 20-14 AWG

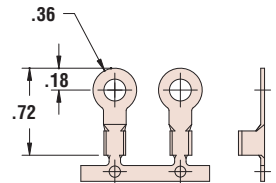

Ring 16-12 AWG

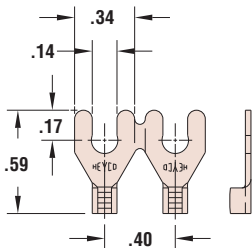

Spade 24-18 AWG

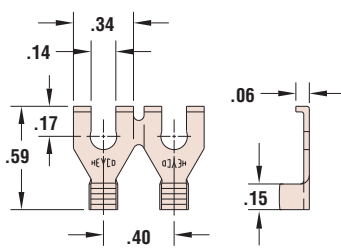

Spade 18-14 AWG (shown w/90° lock)

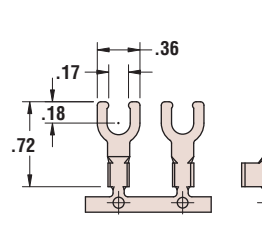

Spade 16-12 AWG

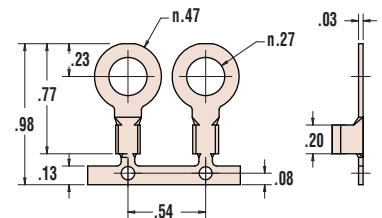

Ring 8146

Materials

Alloy 260 Brass (70% Cu, 30% Zn. Higher Cu content resists dezincification)

Tin-Pl = Brass, Tin plated before or after stamping

Certifications

UL Listed under Underwriters' Laboratories File E95474

Quick Specs



- **Easy loading for increased molding efficiency.**
- Use inexpensive Heyco load pins (consult Heyco for details on our complete line of blades and pins).
- **Reduce PVC usage** and allow more cavities per mold.
- All Ground blades feature 90° leg for **twist-locking mechanism.**
- .056" gauge material, cut-out shapes and radius are all UL Specified.
- DFARS Compliant

Heyco® Turn-2-Lock Cordset Contacts

For Finished, Custom Turn-2-Lock Cord and Plug Sets, see Section 9
15 Amp

PART DATA			PART NO.	APPLICATION TOOLING*				
Type	AWG Range	Material		Die**	Feeds	Tool Packs	Crimp Punch	Anvil
Male - for snap together			Male Nylon Premold Bridges see page 8-20					
TL-L5-15-W&B†	18-14	Brass	6150	6150UXX5	Bulk	B958/B959	C663	C667
TL-L5-15-G	18-14	Brass	6152	6152UXX5				
TL-L5-15-W&B†	16-10	Brass	6110	6110UXX5				
		Tin-Pl	6111	6111UXX5				
		Post-Ni	6126	6126UXX5				
TL-L5-15-G	16-10	Brass	6112	6112UXX5				
		Tin-Pl	6113	6113UXX5				
		Post-Ni	6127	6127UXX5				
TL-L6-15-G	18-14	Brass	6164	6164UXX5				
	16-10	Brass	6134	6134UXX5				
TL-L7-15-G	18-14	Brass	6160	6160UXX5				
	16-10	Brass	6130	6130UXX5				
Female - for snap together			Female Nylon Premold Shells see page 8-20					
TLR-L5-15	16-10	Brass	7550	7550UXX5	Left to Right	B972L/B973L	C784	C783
TLR-L7-15	16-10	Brass	7551	7551UXX5	Left to Right	B972L/B973L	C784	C783

* Use the Heyco Universal Applicator Die (indicated by “U” in the Die Part No.), page 8-59.

** “XX” represents Wire Gauge. Please specify Wire Gauge when ordering.

† Can be used for L6 and L7-15 configurations.

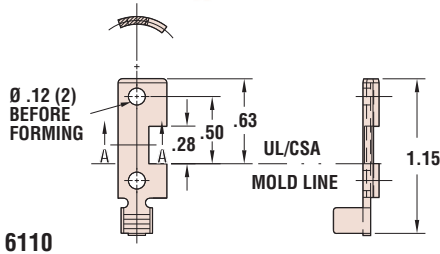

6110

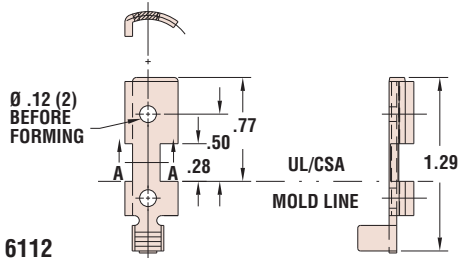

6112

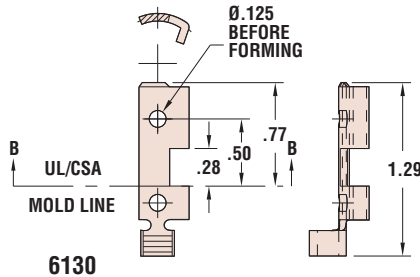

6130

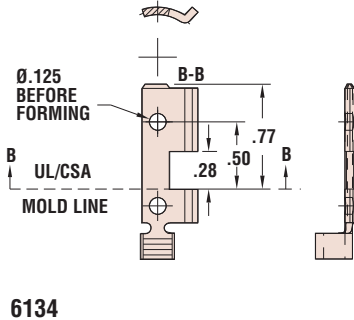

6134

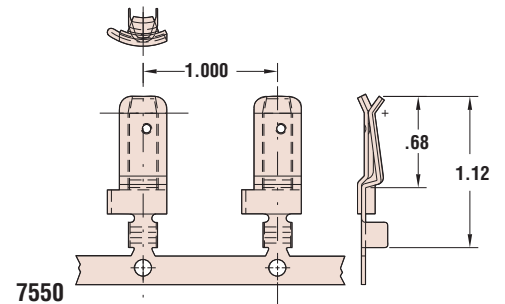

7550

Quick Specs

Materials

Alloy 260 Brass (70% Cu, 30% Zn. Higher Cu content resists dezincification)
 Tin-Pl = Brass, Tin plated before or after stamping
 Post-Ni = Brass, Nickel plated after stamping
 6/6 Nylon



Heyco® Turn-2-Lock Cordset Contacts

For Finished, Custom Turn-2-Lock Cord and Plug Sets, see section 9
20 Amp

Type	PART DATA		PART NO.	APPLICATION TOOLING*				
	AWG Range	Material		Die**	Feeds	Tool Packs	Crimp Punch	Anvil
Male - for snap together Male Nylon Premold Bridges see page 8-20								
TL-L5-20-B	18-14	Brass	6156	6156UXX5	Bulk	B958/B959	C663	C667
TL-L5-20-W	18-14	Brass	6154	6154UXX5				
TL-L20-G	18-14	Brass	6158	6158UXX5				
TL-L5-20-W†	16-10	Brass	6114	6114UXX5				
		Tin-PI	6115	6115UXX5				
TL-L5-20-B†	16-10	Brass	6116	6116UXX5				
		Tin-PI	6117	6117UXX5				
TL-L5-20-G	16-10	Brass	6118	6118UXX5				
		Tin-PI	6119	6119UXX5				
TL-L7-20-G	18-14	Brass	6162	6162UXX5				
		Brass	6132	6132UXX5				
TL-L24-20-G	18-14	Brass	6168	6168UXX5				
		Brass	6138	6138UXX5				
Female - for snap together Female Nylon Premold Shells see page 8-20								
TLR-L5-20	16-10	Brass	7552	7552UXX5	Left to Right	B972L/B973	C784	C783

* Use the Heyco Universal Applicator Die (indicated by "U" in the Die Part No.), page 8-59.

** "XX" represents Wire Gauge. Please specify Wire Gauge when ordering.

† Can be used for L7 and L24 configurations.

- **Easy loading for increased molding efficiency.**
- Use inexpensive Heyco load pins (consult Heyco for details on our complete line of blades and pins).
- **Reduce PVC usage** and allow more cavities per mold.
- All Ground blades feature 90° leg for **twist-locking mechanism.**
- .056" gauge material, cut-out shapes and radius are all UL Specified.
- DFARS Compliant

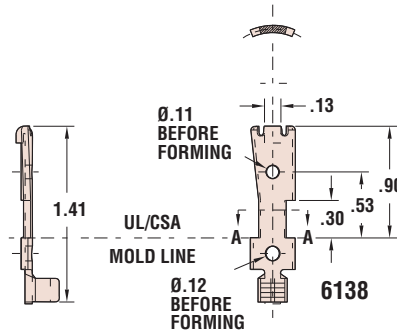
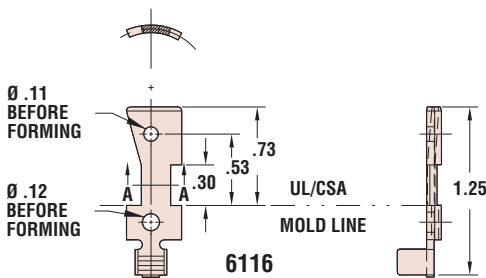
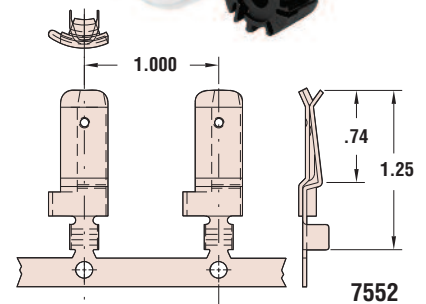
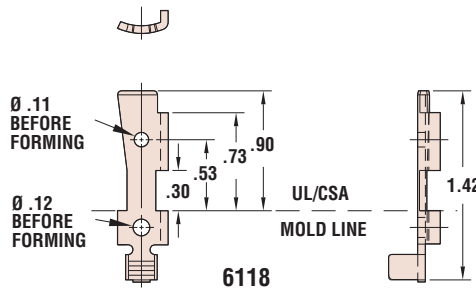
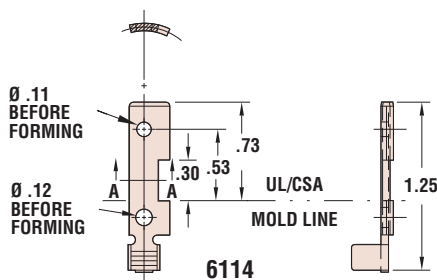

Materials

Alloy 260 Brass (70% Cu, 30% Zn. Higher Cu content resists dezincification)
 Tin-PI = Brass, Tin plated before or after stamping
 6/6 Nylon

Quick Specs

“Stay Connected” with



Power Components

a PennEngineering® Company



- .068" gauge material, cut-out shapes and radius are all UL Specified.
- DFARS Compliant

Heyco® Turn-2-Lock Cordset Contacts

For Finished, Custom Turn-2-Lock Cord and Plug Sets, see Section 9

30 Amp

Type	PART DATA		PART NO.	APPLICATION TOOLING*				
	AWG Range	Material		Die**	Feeds	Tool Packs	Crimp Punch	Anvil
Male - for Male Nylon Premold Bridges see page 8-20								
TL-L5-30-W	10-8	Brass	6120	6120UXX5				
TL-L5-30-B	10-8	Brass	6122	6122UXX5	Bulk	B958/B959	C663	C667
TL-L5-30-G	10-8	Brass	6124	6124UXX5				

* Use the Heyco Universal Applicator Die (indicated by “U” in the Die Part No.), page 8-59.
 ** “XX” represents Wire Gauge. Please specify Wire Gauge when ordering.

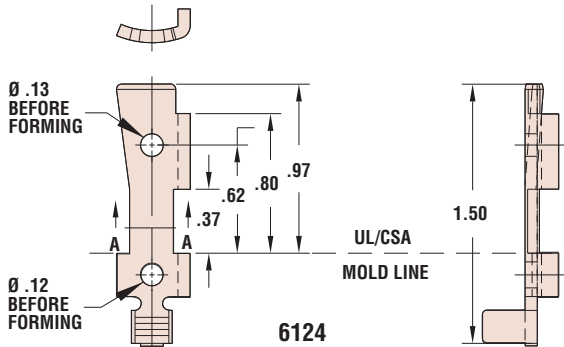
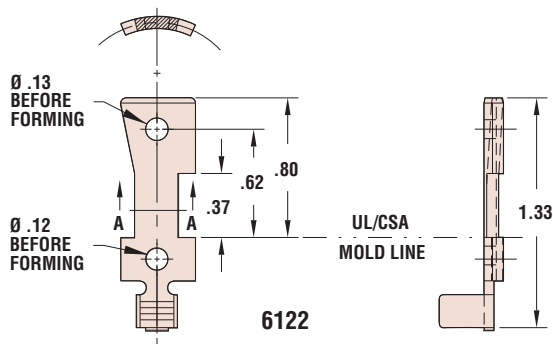
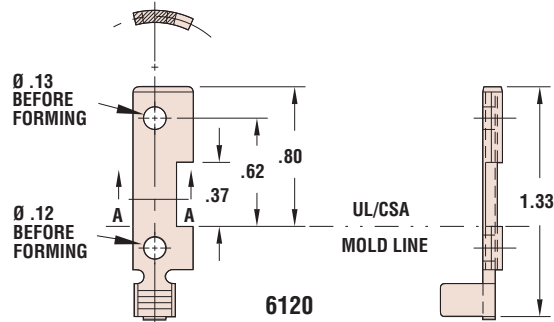
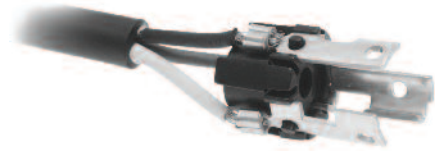

Quick Specs

Materials Alloy 260 Brass (70% Cu, 30% Zn. Higher Cu content resists dezincification)
 6/6 Nylon

Certifications Listed under UL File E217650 for use with Cordsets under UL 817 applications (Cordset Components only)

Heyco® Nylon Premolds

Reduce PVC usage and increase over molding efficiency

Eliminate the need for expensive cammed molds

Female Turn-2-Lock Premold Shells

For Finished Female T2L Configurations, see page 9-2

PART NO. Natural	DESCRIPTION	NEMA Config.	AMPS	For Contacts See Page
7756	125V 15A FEM TL 2PC PREMOLD	L5-15R	15	8-17
7752	277V 15A FEM TL 2PC PREMOLD	L7-15R		
7758	125V 20A FEM TL 2PC PREMOLD	L5-20R	20	8-18

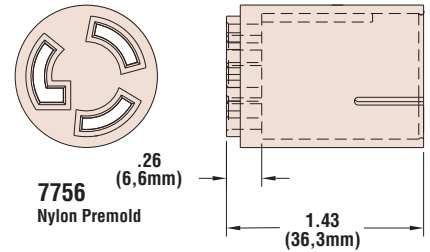

7756
Nylon Premold

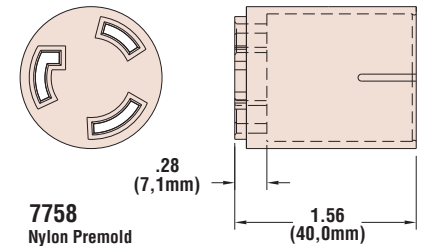

7758
Nylon Premold

Male Turn-2-Lock Premold Bridges

For Finished Male T2L Configurations, see pages 9-3 thru 9-6

PART NO. Black	DESCRIPTION	NEMA Config.	AMPS	For Contacts See Page		
S7424	125V 15A Male TL Premold	L5-15P	15	8-17		
S7428	250V 15A Male TL Premold	L6-15P				
S7420	277V 15A Male TL Premold	L7-15P				
S7426	125V 20A Male TL Premold	L5-20P	20	8-18		
S7422	277V 20A Male TL Premold	L7-20P				
S7432	347V 20A Male TL Premold	L24-20P				
S7434	480V 20A Male TL Premold	L8-20P				
S7438	125V 30A Male TL Premold	L5-30P			30	8-19
S7436	250V 30A Male TL Premold	L6-30P				



- Nylon male premold for use with Heyco blades and pins (consult Heyco for details on our complete line of blades and pins).
- **Reduce PVC usage and increase molding efficiency.**

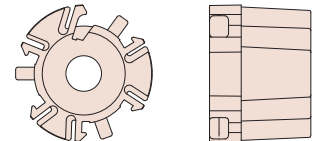

7420
Male Bridge (typical)
Nylon Premold

IEC-320 C13 Receptacle Shell - Body & Cover

For preassembled IEC-320 C13 Premold including contacts, see pg 8-25

PART NO. Black	DESCRIPTION
S7780	IEC-320 C13 PREMOLD SET

- IEC-320 C14 Plug available, see page 6-40.

Tri-Tap Power Block Shell - Body & Cover

For preassembled Tri-Tap Premolds including contacts, see page 8-21

PART NO.		DESCRIPTION
Black	Natural	
0387	0387EE	Tri-Tap Body
0388	0388EE	Tri-Tap Cover

Materials 6/6 Nylon

Quick
Specs

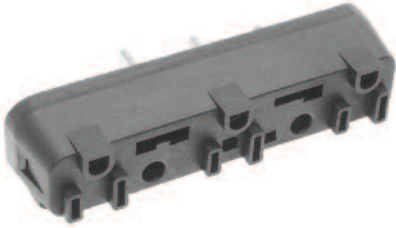

Heyco® Preassembled Cordset Components

For Heyco Application Equipment, see pages 8-59 & 8-60

Tri-Tap Premold–NEMA 5-15R

- Multiple piece unit that reduces the number of crimp connections on a Tri-Tap extension cord from 9 down to 3. **Now you can crimp all 3 terminals at once.**
- Significantly reduce the amount of material required for overmolding, substantially **reducing the cycle time and cost.**
- Available in assembled or component form.
- **Heyco Contacts MUST be used in Heyco pre-molds.**
- DFARS Compliant

PART DATA			PART NO.	APPLICATION TOOLING*		
Type	Color	AWG Range		Die**	Crimp Punch	Anvil
Female Receptacle	Black	18-14	S7403	S7403SXX5	C862, C863	C851
		14-10	S7400	S7400SXX5	C856, C857	

* Use the Heyco Standard Applicator Die (indicated by the second "S" in the Die Part No.), page 8-59.

** "XX" represents Wire Gauge. Please specify Wire Gauge when ordering.

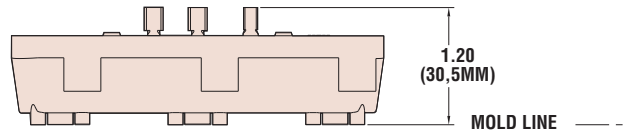

S7403

Components For Tri-Tap Premold

- **S7403**
 - 0387 Tri-Tap Body for S7403 and S7400 (see page 8-20)
 - 0388 Tri-Tap Cover for S7403 and S7400 (see page 8-20)
 - 8077 Tri-Tap Blade (18-14 AWG)
 - 8078 Tri-Tap Blade (18-14 AWG)
 - 8092 Tri-Tap Ground (18-14 AWG)
- **S7400**
 - 8075 Tri-Tap Blade (14-10 AWG)
 - 8076 Tri-Tap Blade (14-10 AWG)
 - 8087 Tri-Tap Ground (14-10 AWG)

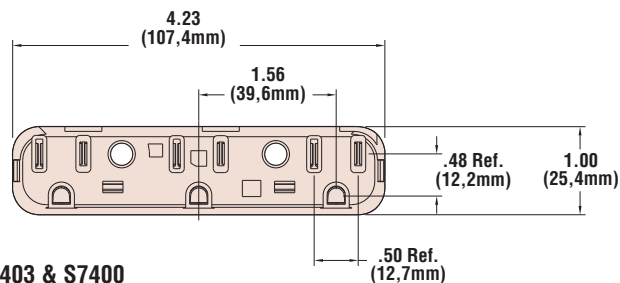

S7403 & S7400

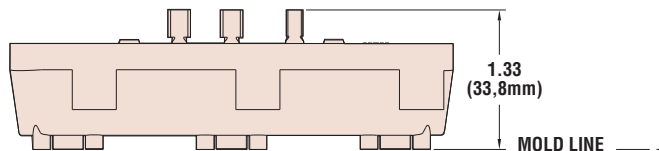

S7400

Quick Specs

Materials	Alloy 260 Brass (70% Cu, 30% Zn. Higher Cu content resists dezincification) 6/6 Nylon
Standards	NEMA 5-15R
Voltage/Current Rating	125 Volts, 15 Amps



Heyco® Preassembled Cordset Components

For Heyco Application Equipment, see pages 8-59 and 8-60

Female Bridge—NEMA 5-15R

Type	PART DATA		PART NO.	APPLICATION TOOLING*			
	Color	AWG Range		Die	Feeds	Crimp Punch	Anvil
5-15R Female Bridge	Black	18-12	S7570	Z370	Semi-Auto*	Z335, Z409	Z334
	Natural	18-12	S7571				
	Clear	18-12	S7574**				
5-15R Female Bridge	Black	12-10	S7572	Z641	Semi-Auto*	Z636, Z637	Z635
	Natural	12-10	S7573				
	Clear	12-10	S7575**				

* Semi-Automatic Terminating Equipment is available, see below and page 8-60.

**Clear bridges are not UL recognized.

- Crimp all three terminals at once.
- Faster loading of plug molds.
- **Reduce plug molding and cycle time.**
- Assure reliable contact performance.
- Improve plug quality.
- **Reduce PVC usage and plug cost!**
- Eliminate the need for a polarity barrier.
- Pass UL/CSA cold temperature insertion test.
- Automated terminating equipment is available, see page 8-60.
- DFARS Compliant

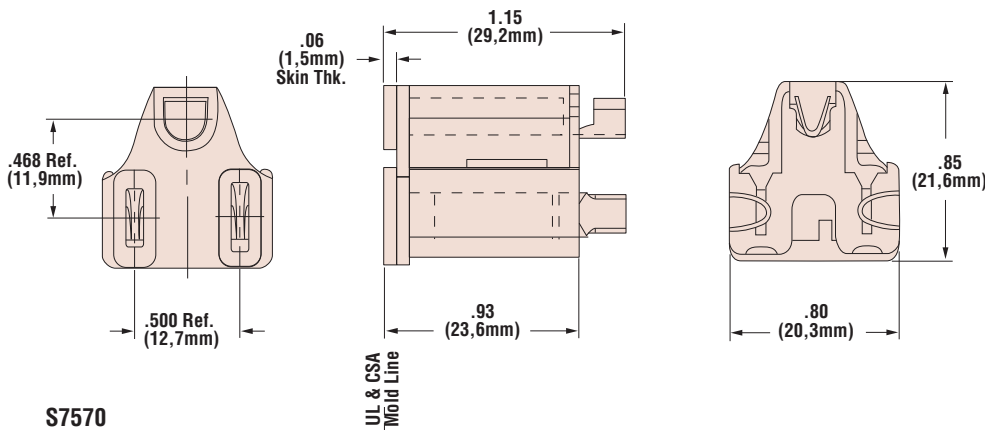

S7570

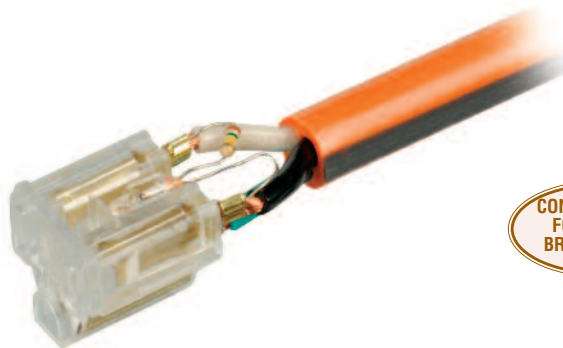

CONSULT HEYCO FOR FEMALE BRIDGES WITH LIGHT

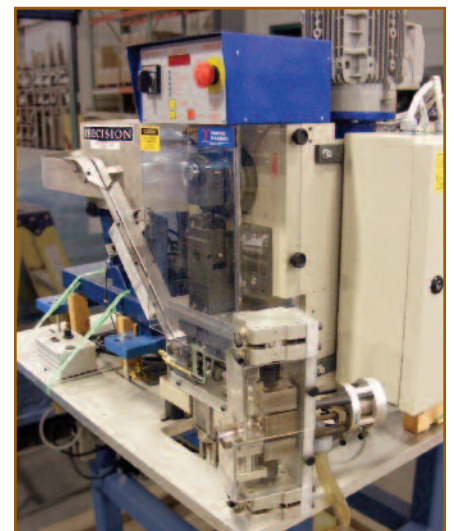

Heyco Female Bridge Machine (see page 8-60)

Materials	Alloy 260 Brass (70% Cu, 30% Zn. Higher Cu content resists dezincification)
	Black and Natural - 6/6 Nylon, Clear - Polycarbonate
Certifications	Recognized Component under UL File E231361
Standards	NEMA 5-15R

Quick Specs



- Crimp all three terminals at once.
- Faster loading of plug molds.
- Reduce plug molding and cycle time.
- Reduce plug cost while improving plug quality.
- 7-Shape blades feature ledge to maintain position during overmolding.
- Pass elevated temperature pullout test with low cost PVC.
- Automated terminating equipment is available, see page 8-60.
- See page 8-60 for wire stripper information.
- DFARS Compliant

Heyco® Preassembled Cordset Components

For Heyco Application Equipment, see pages 8-59 and 8-60

Male Bridge–NEMA 5-15P

PART DATA				APPLICATION TOOLING*				CRIMP DIMENSIONS																			
Type	Color	AWG Range	PART	Die	Feeds	Crimp Punch	Anvil	A in.	B in.																		
5-15P Male Bridge	Black	18-14	S7560	Z360	Semi-Auto*	Z318, Z408	Z302	.26	.40																		
	Natural	18-14	S7561																								
	Clear	18-14	S7596																								
5-15P Male Bridge Tinned	Black	18-14	S7564							Z461	Semi-Auto*	Z446, Z454, Z444, Z453	Z445	.30	.44												
	Natural	18-14	S7599																								
	Clear	18-14	S7598																								
5-15P Male Bridge 7-Shape	Black	18-14	S7563													Z461	Semi-Auto*	Z446, Z454, Z444, Z453	Z445	.30	.44						
	Natural	18-14	S7581																								
	Clear	18-14	S7581																								
5-15P Male Bridge 7-Shp Tinned	Black	18-14	S7583																			Z461	Semi-Auto*	Z446, Z454, Z444, Z453	Z445	.30	.44
	Natural	18-14	S7585																								
	Clear	18-14	S7584																								
5-15P Male Bridge 7-Shape Nickel Plated**	Black	18-14	S7567	Z461	Semi-Auto*	Z446, Z454, Z444, Z453	Z445	.30	.44																		
5-15P Male Bridge	Black	12-10	S7590																								
	Natural	12-10	S7592																								
	Clear	12-10	S7597																								
5-15P Male Bridge Tinned	Black	12-10	S7594							Z461	Semi-Auto*	Z446, Z454, Z444, Z453	Z445	.30	.44												
	Natural	12-10	S7577																								
	Clear	12-10	S7576																								
5-15P Male Bridge 7-Shape	Black	12-10	S7591													Z461	Semi-Auto*	Z446, Z454, Z444, Z453	Z445	.30	.44						
	Natural	12-10	S7593																								
	Clear	12-10	S7589																								
5-15P Male Bridge 7-Shp Tinned	Black	12-10	S7595																			Z461	Semi-Auto*	Z446, Z454, Z444, Z453	Z445	.30	.44
	Natural	12-10	S7579																								
	Clear	12-10	S7578																								

NEW!

NEW!

NEW!

NEW!

7-Shape Blades feature a retention ledge to maintain position during overmolding (mold stop).

*Semi-Automatic Terminating Equipment is available, see below and page 8-58.

**For harsh environments.



Heyco Male Bridge Machine
(see page 8-60)

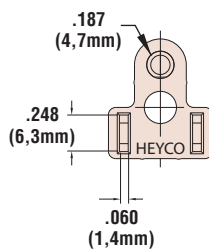

S7560

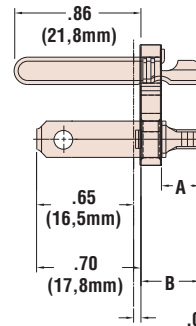

.050 REC. OVERMOLD THICKNESS ON FACE

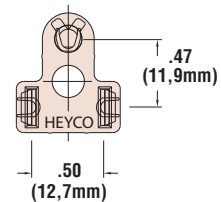

Quick
Specs

Materials

Alloy 260 Brass (70% Cu, 30% Zn. Higher Cu content resists dezincification)

Black and Natural - 6/6 Nylon, Clear - Polycarbonate

Certifications



Recognized Component under UL File E164169 (Component Blades only)



Certified by the Canadian Standards Association File 91824

Standards

NEMA 5-15P

Heyco® Preassembled Cordset Components

For Heyco Application Equipment, see pages 8-59 and 8-60

Male Padded Bridge–NEMA 5-15P

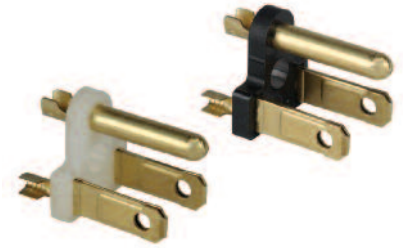

PART DATA	PART			APPLICATION TOOLING*				CRIMP DIMENSIONS	
	Type	Color	AWG Range	NO.	Die	Feeds	Crimp Punch	Anvil	A in.
5-15P Male Padded Bridge	Black	18-14	S7568	Z294	Semi-Auto*	Z318, Z291	Z290	.26	.40
	Natural	18-14	S7569						
	Clear	18-14	S7582						
5-15P Male Padded Bridge Tinned	Black	18-14	S7586	Z294	Semi-Auto*	Z318, Z291	Z290	.26	.40
	Natural	18-14	S7588						
	Clear	18-14	S7587						

*Semi-Automatic Terminating Equipment is available, see page 8-60.

- Heyco Padded Blades are **far less expensive** than their Full Thickness counterparts (pages 8-31 thru 8-34), yet they are functionally equivalent.
- Thinner gauge material lowers cost, yet full pad configuration meets UL power cord requirements, including **UL 1659**.
- Heyco Padded Blades utilize less brass but retain all of the strength of our Full Thickness Blades, at a **lower cost**.
- Our Padded Bridge design **accommodates existing overmolds** designed for Padded Blades.
- Automated terminating equipment is available, see page 8-60.
- See page 8-60 for wire stripper information.
- DFARS Compliant

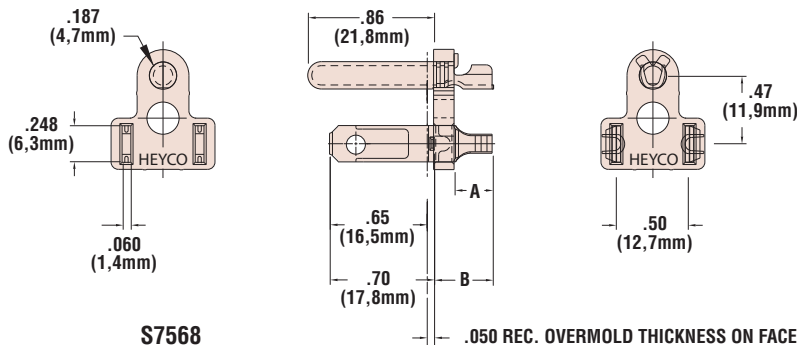

S7568

Materials	Alloy 260 Brass (70% Cu, 30% Zn. Higher Cu content resists dezincification) Nylon 6/6
Certifications	Recognized Component under UL File E164169 (Component Blades only) Certified by the Canadian Standards Association File 91824
Standards	NEMA 5-15P

Quick Specs

“Stay Connected” with



Power Components

a PennEngineering® Company



- Crimp all three terminals at once.
- **Faster loading of plug molds.**
- Assure reliable contact performance.
- Improve plug quality.
- **Reduce PVC usage and plug cost!**
- Available assembled or unassembled.
- Automated terminating equipment is available. Consult Heyco for details.
- IEC 60320 compatible.
- For Heyco's IEC-14 Plug, see page 6-42.
- DFARS Compliant

Heyco® Preassembled Cordset Components

IEC-320 Business Machine Assembly - C13 Female - 250V, 10 Amps

PART DATA			PART NO.	APPLICATION TOOLING*			
Type	Color	AWG Range		Die**	Feeds	Crimp Punch	Anvil
IEC-320 Biz Machine Assembly	Black	18-14	S7580	S7580SXX5	-	C774	C775
Unassembled IEC-320 Housing	Black	n/a	S7780				

* Use the Heyco Standard Applicator Die (indicated by the second “S” in the Die Part No.), page 8-59
 ** “XX” represents Wire Gauge. Please specify Wire Gauge when ordering.

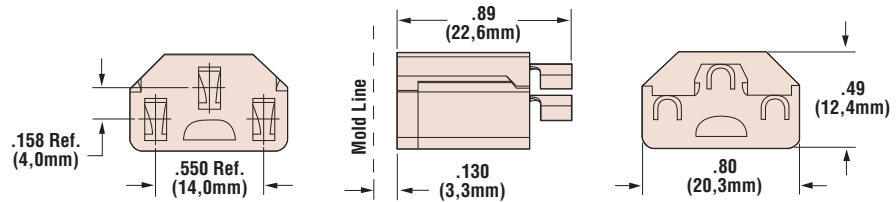

S7580



7216

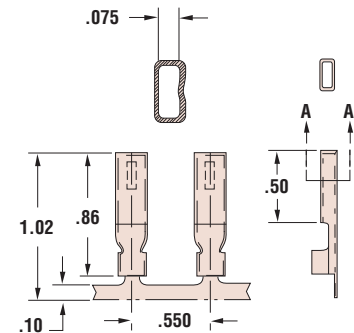

BMC-1

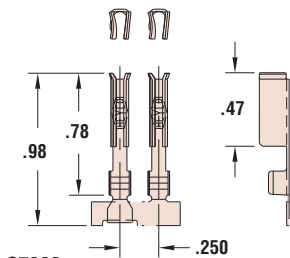

S7200

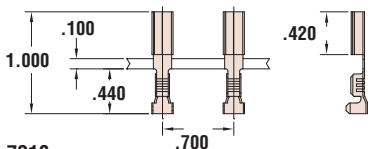
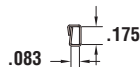

7218

Heyco® Business Machine Female Connectors

IEC-320 - C13 Female - 250V, 10 Amps

PART DATA				PART NO.	APPLICATION TOOLING*				
Type	Gap mm.	AWG Range	Material		Die**	Feeds	Tool Packs	Crimp Punch	Anvil
Crimp	-	18-14	Brass	7216	7216UXX5	Left to Right	B954L/B955L	C655	C658
Insulation Crimp†	-	18-14	Brass	7218	7218UXX5	Left to Right	B956L/B957L		
BMC-1 .070~	1,8	18-12	Brass	7221	7221UXX5	Left to Right	B440L/B441L	C128	C130
BMC-1 .075~	1,9	18-12	Brass Tin-Pl	7220 7222	7220UXX5 7222UXX5				
Unassembled BMC IEC-320 Contact		18-14	Brass	S7200	S7200UXX5 S7200SXX5	Left to Right	B964L/B965L	C688	C689

* Use the Heyco Universal Applicator Die (indicated by “U” in the Die Part No.), page 8-59.

For Part No. S7200, the Heyco Standard Applicator Die may also be used.

** “XX” represents Wire Gauge. Please specify Wire Gauge when ordering.

† Insulation Crimp Terminals provide **strain relief** as well as **support** for insertion into the housing.

Materials

Alloy 260 Brass (70% Cu, 30% Zn. Higher Cu content resists dezincification)

Tin-Pl = Brass, Tin plated before or after stamping

6/6 Nylon



Heyco® Business Machine Male Contacts

European Style, Folded Design - IEC-320 - C14 Male - 250V, 10 Amps

Type	PART DATA			PART NO.	APPLICATION TOOLING*				
	Euro Mold Line mm.	AWG Range	Material		Die**	Feeds	Tool Packs	Crimp Punch	Anvil
Strain Relief Leg	12/15	18-14	Tin-Pl	5759	5759UXX5	Left to Right	B104L/B105L	C296	C304
				5760	5760UXX5	Right to Left	B104R/B105R		
Flat	12/15	18-14	Tin-Pl	8151	8151UXX5	Left to Right	B104L/B105L	C296	C304
			Post-Ni	8153	8153UXX5				
			Tin-Pl	8150	8150UXX5	Right to Left	B104R/B105R		
Flat w/ Disc Tab	12/15	18-14	Tin-Pl	8156	-	Bulk	-	-	-
Length									
Solder	23,9	-	Brass	5770	-	Bulk	-	-	-
	26,9	-	Brass	5771	-				

- IEC 60320 compatible.
- For Heyco's IEC-14 Plug, see page 6-42
- DFARS Compliant

* Use the Heyco Universal Applicator Die (indicated by "U" in the Die Part No.), page 8-59.

** "XX" represents Wire Gauge. Please specify Wire Gauge when ordering.

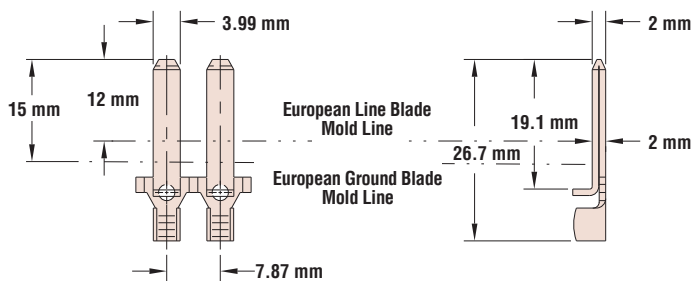

Strain Relief Leg

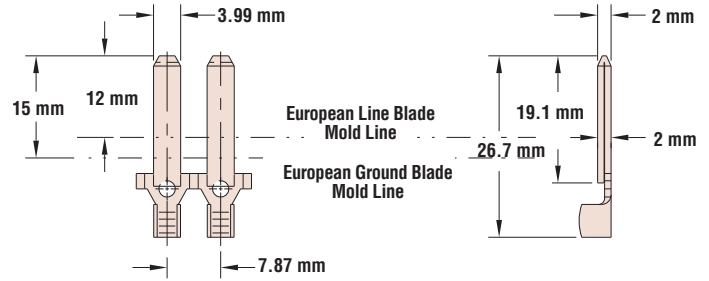

Flat

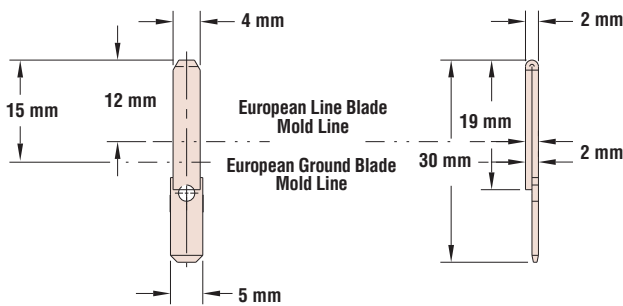

Flat with Disc Tab

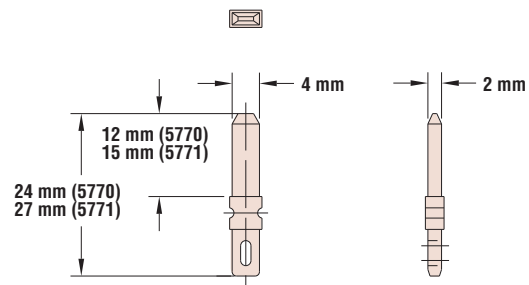

Solder

Materials

Alloy 260 Brass (70% Cu, 30% Zn. Higher Cu content resists dezincification)
 Tin-Pl = Brass, Tin plated before or after stamping
 Post-Ni = Brass, Nickel plated after stamping

Quick Specs



Heyco® Heavy Duty Male Blades for Range and Dryer

See Pages 8-43 & 8-44 for Heavy Duty Ground Pins

127 Series

- Heavy Duty Terminal Blade.
- 30, 50, and 60 Amp rating.
- Flag type construction for right angle and straight thru plugs.
- Conductor crimp ears only
- DFARS Compliant

128 Series

- Shorter length and smaller crimp ears than the 127 Series and thus lower in cost.
- Conductor crimp ears only.
- DFARS Compliant

375 Series

- a.k.a. “Travel Trailer” terminal blade.
- 30 Amp rating.
- Flag type construction for right angle and straight thru plugs.
- Conductor crimp ears only.
- DFARS Compliant

310 Series

- Shorter in length and narrower than 375 Series.
- 20 Amp rating.
- Flag type construction for right angle and straight-thru plugs features a strain relief “knee” for added pull out protection.
- DFARS Compliant

Padded HD Blades (“PAD”) versus Flat HD Blades:

- Flat Heavy Duty Blades are **front loaded** for overmolding.
- Due to their shaped profiles, Padded Heavy Duty Blades are **side loaded** for overmolding.
- Heyco Heavy Duty **Padded Blades** are **far less expensive** than their Flat counterparts, yet they are functionally equivalent and evaluated and approved by UL for use in UL 817 applications.
- DFARS Compliant

PART DATA			PART NO.	APPLICATION TOOLING*			
Type	AWG Range	Material		Die**	Feeds	Crimp Punch	Anvil
127 Series							
.500 Range/Dryer Blade	10-6	Brass	6000	6000SXX5	Bulk	0V23	0V22
		Tin-Pi	6001	6001SXX5			
		Post-Ni	5999	5999SXX5			
		Brass	6004	6004SXX5	Dual		
127-3 Series							
.315 Range/Dryer Blade	10-6	Brass	6010	6010SXX5	Bulk	0V23	0V22
		Tin-Pi	6011	6011SXX5			
		Brass	6012	6012SXX5	Dual		
127-PAD Series - evaluated and approved by UL for use in UL817 applications							
Padded Range/Dryer Blade	12-8	Brass	6020	6020SXX5	Bulk	0V75	0V74
			6021	6021SXX5	Dual		
127-90 Series							
90° Range/Dryer Ground Blade	10-8	Brass	6002	6002SXX5	Bulk	0W83	0W82
		Tin-Pi	6003	6003SXX5			
		Brass	6005	6005SXX5	Left to Right	0V59	0V58
			6006	6006SXX5			
127-90-SC Series - Small Crimp							
90° R/D Ground Small Crimp	12-8	Brass	6007	6007SXX5	Bulk	0V92	0V90
128 Series							
.500 R/D Line Blade	12-8	Brass	6015	6015SXX5	Bulk	0V41	0V40
			6017	6017SXX5	Dual		
128-3 Series							
.315 R/D Line Blade	12-8	Brass	6016	6016SXX5	Bulk	0V41	0V40
			6018	6018SXX5	Dual		
128-PAD Series - evaluated and approved by UL for use in UL817 applications							
Padded R/D Line Blade	12-8	Brass	6013	6013SXX5	Bulk	0V74	0V75
			6014	6014SXX5	Dual		
375 & 310 Series							
.375 Line Blade	14-10	Brass	5950	5950SXX5	Bulk	0B95	0B94
			5951	5951SXX5	Dual		
.310 Line Blade	14-10	Brass	6051	6051SXX5	Bulk	0A03	05C8

* Use the Heyco Standard Applicator Die (indicated by “S” in the Die Part No.), page 8-59.

** “XX” represents Wire Gauge. Please specify Wire Gauge when ordering.

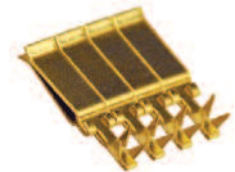

Heyco® Heavy Duty Female Blade

PART DATA			PART NO.	APPLICATION TOOLING*				
Type	AWG Range	Material		Die**	Feeds	Tool Pack	Crimp Punch	Anvil
Wiping Contact	14-12	Brass	7241	7241UXX5	Left to Right	B404L/B405L	C399	C401

* Use the Heyco Universal Applicator Die (indicated by “U” in the Die Part No.), page 8-59.

** “XX” represents Wire Gauge. Please specify Wire Gauge when ordering.

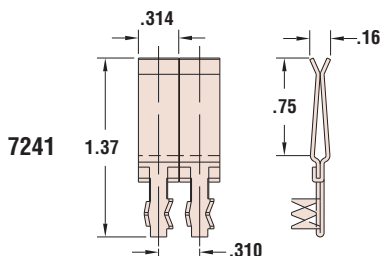

Materials	Alloy 260 Brass (70% Cu, 30% Zn. Higher Cu content resists dezincification) Tin-Pi = Brass, Tin plated before or after stamping Post-Ni = Brass, Nickel plated after stamping
-----------	---

"Stay Connected" with



Power Components

a PennEngineering® Company

Heyco® Heavy Duty Male Blades for Range and Dryer

Heavy Duty Blade Schematics

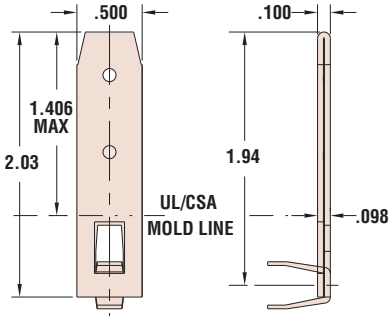

127 Series

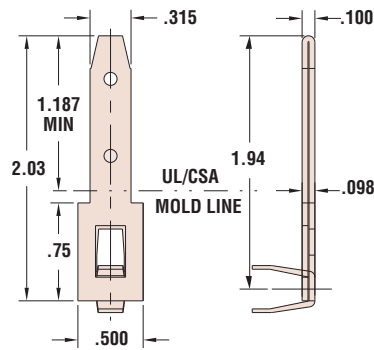

127-3 Series

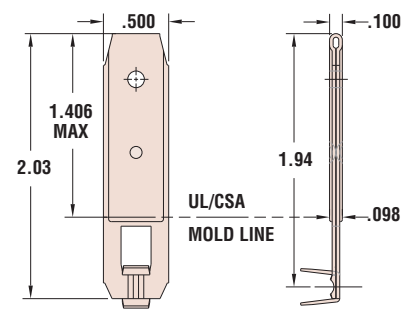

127-PAD Series

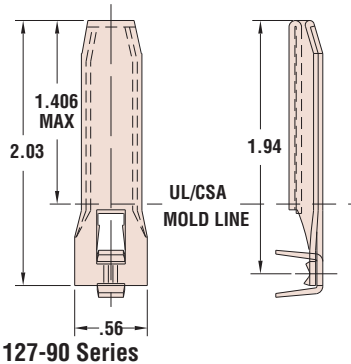
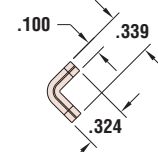
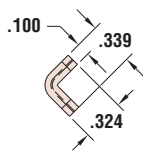

127-90 Series

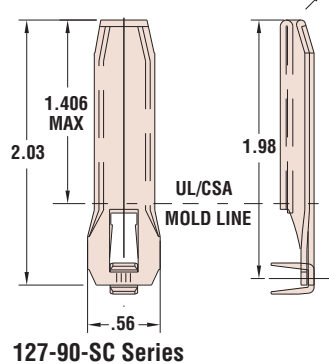

127-90-SC Series

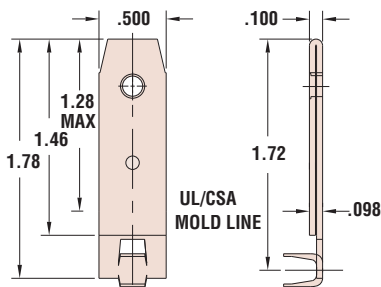

128 Series

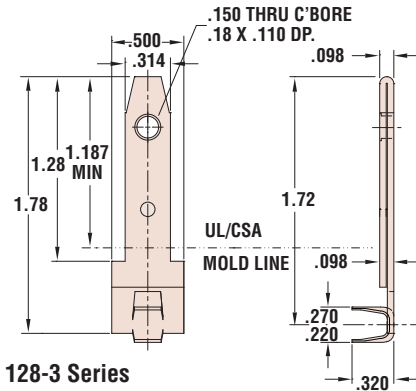

128-3 Series

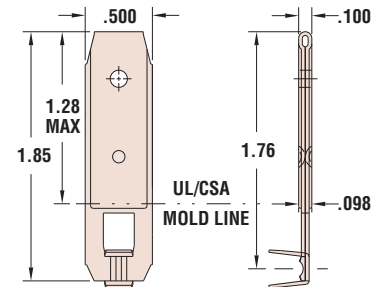

128-PAD Series

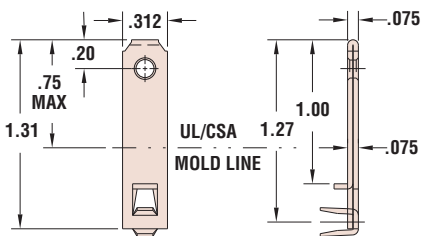

6051 (Bulk)

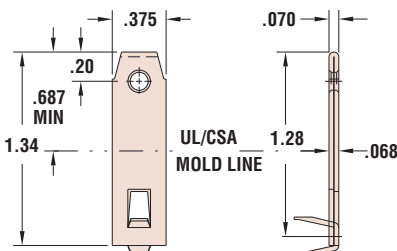

5950 (Bulk)

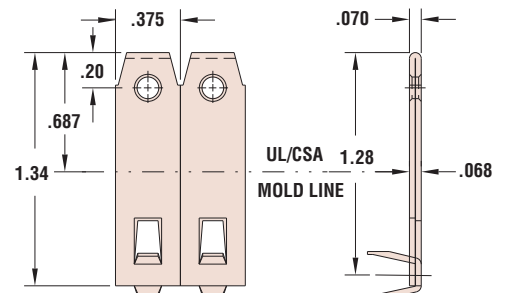

5951 (Strip)



Heyco® Padded Male Blades

For mating Female Cord Connectors, see page 8-50.

For Male Ground Pins, see pages 8-39 & 8-40.

For Padded Male/Female Combination Terminals, see page 8-57.

NEMA 1-15P & 5-15P – .043” Mold Line Thickness

Lower material content makes for a less expensive UL Approved Blade!

- Heyco Padded Blades are **far less expensive** than their Full Thickness counterparts (pages 8-31 thru 8-34), yet they are **functionally equivalent**.
- Thinner gauge material **lowers cost**, yet full pad configuration meets UL power cord requirements, including **UL 1659**.
- All Heyco Padded Blades feature a 90° “knee” section for **strain relief** and assembly orientation.
- For overmolding, Padded Blades must be **side loaded** due to their shaped profile.
- **Series 112** Padded Blades feature a flow-through hole plus “knee” below the mold line for strain relief pull out protection.
- **Series 112-8** Padded Blades feature an extended 90° knee for additional strain relief.
- **Series 103** Polarized Padded Blades are the “heavier duty, full width designed” choice among these lighter duty blades for 18-14 AWG conductors.
- **Series 103-N** Padded Blades are heavier duty and notched to meet high temperature pull out requirements.
- **Series 104 and 104-E** Polarized Blades feature “full narrow” hot (black wire) blade design i.e., the hot blade does not taper at the tip for added strength and appearance.
- **Series 104-E** Insulation Crimp Blades provide strain relief and wire support for shock and vibration resistance, and support for insertion into the mold block.
- DFARS Compliant

PART DATA			PART NO.		APPLICATION TOOLING*					
Length Below Mold Line	AWG Range	Material	Die**		Feeds	Tool Packs	Crimp	Anvil		
			Non-polarized	Polarized						
Series 112 - Flow-Through Hole Plus “Knee” for Strain Relief Protection										
.37	22-20	Brass	5048	5049	5048UXX5	5049UXX5	Left to Right	B100L/B101L	C236	C254
	18-14	Brass	-	5046	-	5046UXX5				
			5044	5045	5044UXX5	5045UXX5	Right to Left	B100R/B101R		
Series 112-8 - Extended Knee for Improved Strain Relief										
.37	18-14	Brass	5080	5082	5080UXX5	5082UXX5	Left to Right	B100L/B101L	C236	C254
		Tin-Pl	5084	5086	5084UXX5	5086UXX5				
		Brass	5081	5083	5081UXX5	5083UXX5	Right to Left	B100R/B101R		
		Tin-Pl	5085	5087	5085UXX5	5087UXX5				
Series 103 - Heavier Duty with Strain Relief Knee										
.47	18-14	Brass	5112	-	-	5112UXX5	Left to Right	B100L/B101L	C236	C254
Series 103-N - Heavier Duty; Notched for High Temperature										
.47	18-14	Brass	5181	5183	5181UXX5	5183UXX5	Left to Right	B100L/B101L	C236	C254
		Post-Ni	-	5187	-	5187UXX5				
		Brass	5180	5182	5180UXX5	5182UXX5	Right to Left	B100R/B101R		
Series 104 - Extra Crimp Length and Height; Strain Relief Knee										
.42	18-14	Brass	5121	5123	5121UXX5	5123UXX5	Left to Right	B118L/B119L	C293	C794
Series 104-E - Length Extended for Insulation Crimp; Strain Relief Knee										
.59	18-14	Brass	5125	5127	5125UXX5	5127UXX5	Left to Right	B114L/B115L	C294	C302
		Tin-Pl	5133	5135	5133UXX5	5135UXX5				

* Heyco high volume Application Tooling, designed for 3-5 ton presses - see page 8-59.

Heyco Mini Applicators, designed for 1.5-3 ton bench top presses, are available - see page 8-59.

** “XX” represents Wire Gauge. Please specify Wire Gauge when ordering.

Materials	Alloy 260 Brass (70% Cu, 30% Zn. Higher Cu content resists dezincification) Tin-Pl = Brass, Tin plated before or after stamping Post-Ni = Brass, Nickel plated after stamping
Certifications	Recognized Component under UL File E164169 Certified by the Canadian Standards Association File 91824
Standards	NEMA 1-15P & NEMA 5-15P

Heyco® Padded Male Blades

NEMA 1-15P & 5-15P Padded Blade Schematics

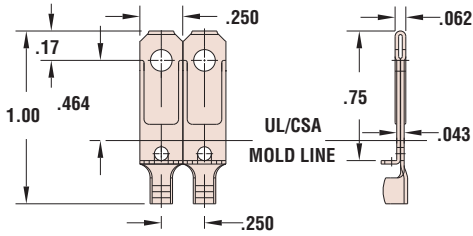
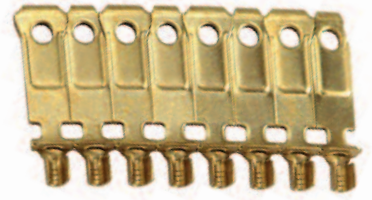

112 Series Non-Polarized

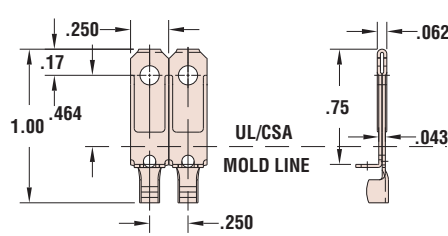

112-8 Series Non-Polarized

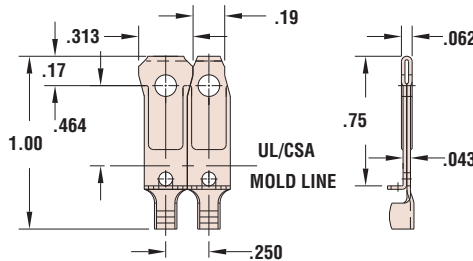

112 Series Polarized

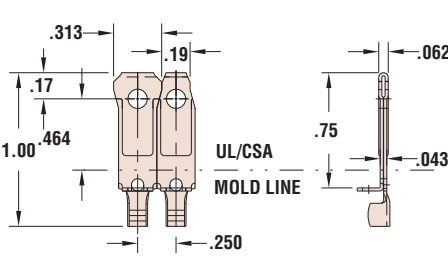

112-8 Series Polarized

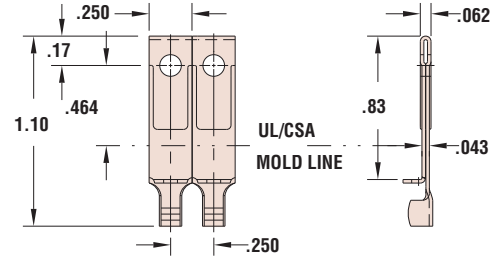

103 Series 1-Hole

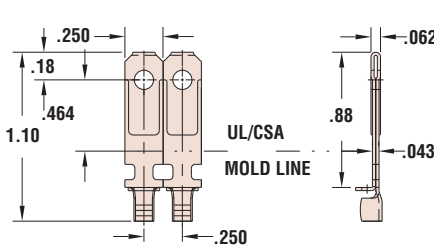

103-N Series Non-Polarized

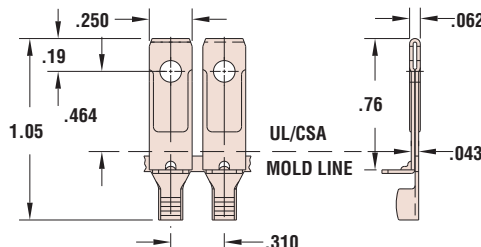

104 Series Non-Polarized

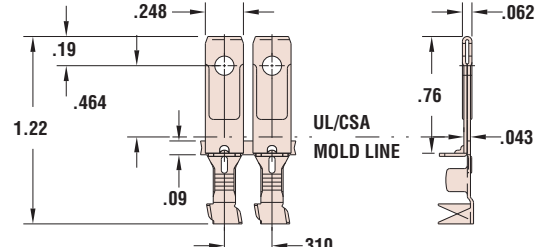

104-E Series Non-Polarized

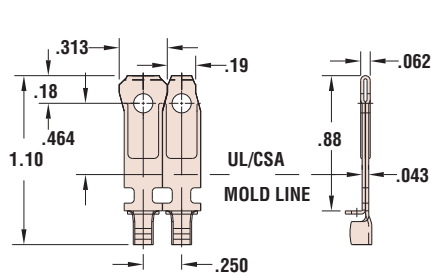

103-N Series Polarized

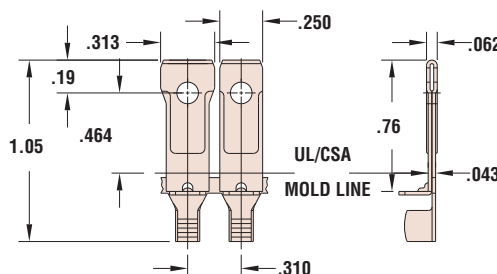

104 Series Polarized

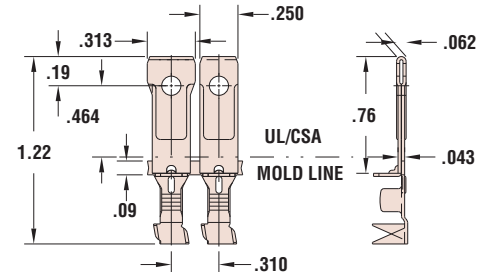

104-E Series Polarized

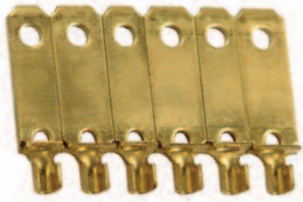

Heyco® Full Thickness Male Blades

For mating Female Cord Connectors, see page 8-50.

For Male Ground Pins, see pages 8-39 & 8-40.

For Full Thickness Male/Female Combination Terminals, see pages 8-55 & 8-56.

NEMA 1-15P & 5-15P – .058” Mold Line Thickness

- All Heyco Full Thickness Blades pass UL 1659 crimp area test requirements.
- All Heyco Full Thickness Blades feature a 90° “knee” section for **strain relief** and assembly orientation. Exceptions: 116 and 116-N Series parts.
- All Flat Full Thickness, Non-Polarized Blades are **front loaded** for overmolding.
- All Polarized and 7-Shape Full Thickness Blades are **side loaded** for overmolding.
- **Series 100** Polarized Blades feature a unique full wide/full narrow design i.e., for strength and appearance, both neutral (white wire) and hot (black wire) have straight sides.
- **Series 110-N and 116-N** Full Thickness Blades are notched to meet high temperature pull out requirements.
- **Series 110-E and 102-E** Insulation Crimp Blades provide strain relief and wire support for shock and vibration resistance, as well as support for insertion into the mold block. Series 102-E Blades are stamped with a carrier strip between blades. These parts accept a wider conductor range than the 110-E Series.
- **Series 116 and 116-N** Blades feature a larger crimp section for heavier 14-10 AWG gauge conductors.
- For strain relief protection, the 116 Series feature a flow-through hole below the mold line and 116-N blades are notched.
- DFARS Compliant

PART DATA			PART NO.		APPLICATION TOOLING*					
Profile	AWG Range	Material	Die**		Feeds	Tool Packs	Crimp Punch	Anvil		
			Non-polarized	Polarized					For Non-polarized	For Polarized
100 Series - Full Wide / Full Narrow Design with Strain Relief Knee										
Flat	18-14	Brass	-	5060	-	5060UXX5	Right to Left	B176R/B177R	C242	C252
			-	5061	-	5061UXX5	Left to Right	B176L/B177L		
110 Series - Standard Blade with Strain Relief Knee										
Flat	18-14	Brass	5400	5423	5400UXX5	5423UXX5				
7-Shape	18-14	Brass Tin-Pl	5415 5445	5421 -	5415UXX5 5445UXX5	5421UXX5 -	Left to Right	B184L/B185L	C234, C714	C253, C715
Flat	18-14	Brass	5403	5424	5403UXX5	5424UXX5	Right to Left	B184R/B185R		
7-Shape	18-14	Brass	5416	5422	5416UXX5	5422UXX5				
110-N Series - Notched for High Temperature										
Flat	18-14	Brass	5460	5462	5460UXX5	5462UXX5	Left to Right	B184L/B185L	C234	C253
7-Shape	18-14	Brass	5470	5472	5470UXX5	5472UXX5				
Flat	18-14	Brass	5461	5463	5461UXX5	5463UXX5	Right to Left	B184R/B185R		
7-Shape	18-14	Brass	5471	5473	5471UXX5	5473UXX5				
110-E Series - Length Extended for Insulation Crimp; Strain Relief Knee										
Flat	18-16	Brass	5407	5420	5407UXX5	5420UXX5	Left to Right	B188L/B189L	C234	C260
7-Shape	18-16	Brass	5417	5414	5417UXX5	5414UXX5				
	18-16	Brass	5437	-	5437UXX5	-				
	18-16	Tin-Pl	5404	-	5404UXX5	-				
Flat	18-16	Brass	5439	-	5439UXX5	-	Right to Left	B188R/B189R		
7-Shape	18-16	Brass	5438	5413	5438UXX5	5413UXX5				
102-E Series - Carrier Strip; Extended Length for Insulation Crimp										
Flat	18-14	Brass	5426	5425	5426UXX5	5425UXX5	Left to Right	B976L/B977L	C825	C826
7-Shape	18-14	Brass	5427	5428	5427UXX5	5428UXX5				
116-Series - For Heavier AWG Conductors										
Flat	14-10	Brass Tin-Pl	5670	5674	5670UXX5	5674UXX5	Left to Right	B196L/B197L	C245	C264
			5673	-	5673UXX5	-				
7-Shape	14-10	Brass	5667	5668	5667UXX5	5668UXX5	Right to Left	B196R/B197R		
			5665	-	5665UXX5	-				
116-N Series - For Heavier AWG Conductors; Notched for High Temperature										
Flat	14-10	Brass	5656	5657	5656UXX5	5657UXX5	Left to Right	B196L/B197L	C245	C264
7-Shape	14-10	Brass	5658	5659	5658UXX5	5659UXX5				
Flat	14-10	Brass	5655	-	5655UXX5	-	Right to Left	B196R/B197R		
115-X Series - Side Folded for Round Edges and Tip										
Flat	18-14	Brass Tin-Pl	5651	-	5651UXX5	-	Bulk Only			
			5652	-	5652UXX5	-				

NEW!

7-Shape Blades feature a retention ledge to maintain position during overmolding (mold stop).

* Heyco high volume Application Tooling, designed for 3-5 ton presses - see page 8-59.

Heyco Mini Applicators, designed for 1.5-3 ton bench top presses, are available - see page 8-59.

** “XX” represents Wire Gauge. Please specify Wire Gauge when ordering.

Quick
Specs

Materials	Alloy 260 Brass (70% Cu, 30% Zn. Higher Cu content resists dezincification) Tin-Pl = Brass, Tin plated before or after stamping
Certifications	Recognized Component under UL File E164169 Certified by the Canadian Standards Association File 91824
Standards	NEMA 1-15P & NEMA 5-15P

Heyco® Full Thickness Male Blades

NEMA 1-15P & 5-15P – .058" Mold Line Thickness Schematics

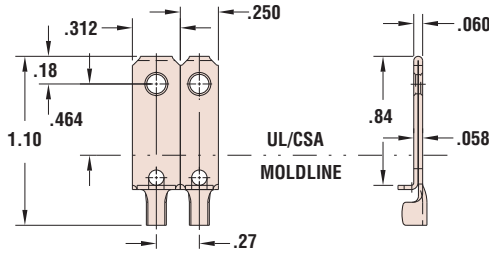
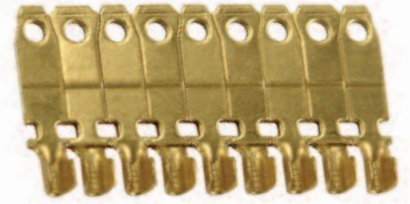

100 Series Polarized

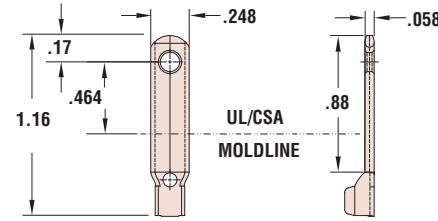

115-X Series

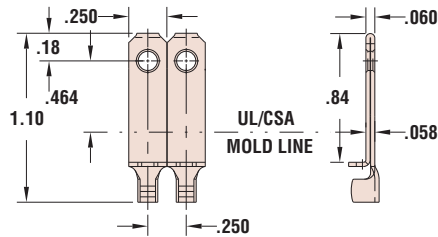

110 Series Non-Polarized

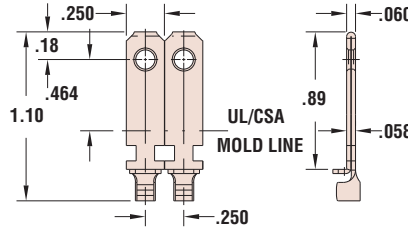

110-N Series Non-Polarized

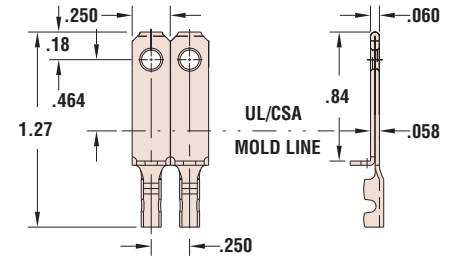

110-E Series Non-Polarized

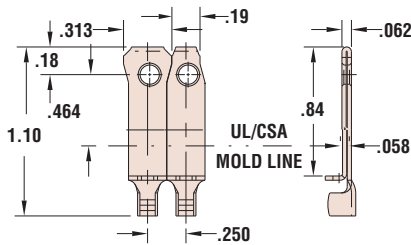

110 Series Polarized

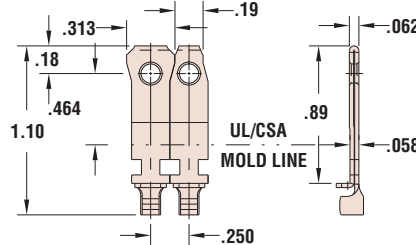

110-N Series Polarized

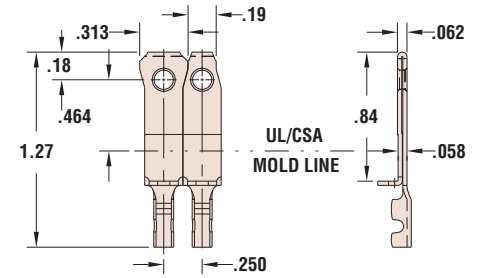

110-E Series Polarized

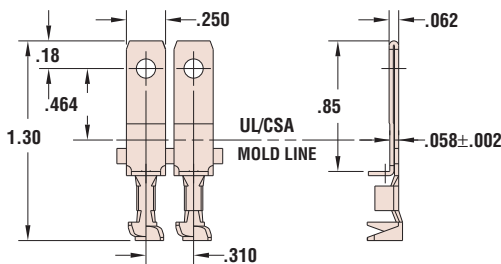

102-E Series Non-Polarized

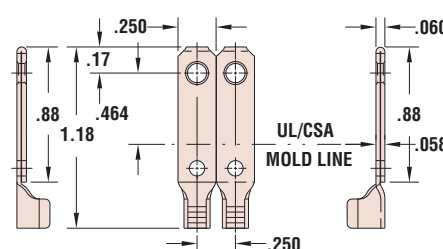

116 Series Non-Polarized

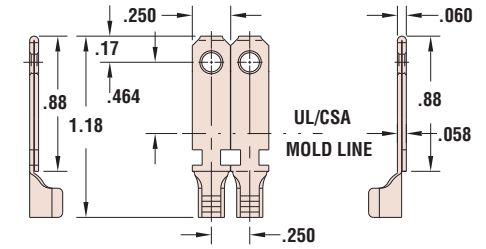

116-N Series Non-Polarized

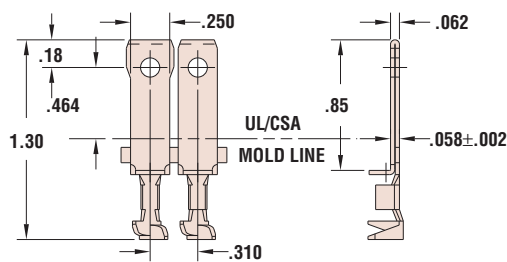

102-E Series Polarized

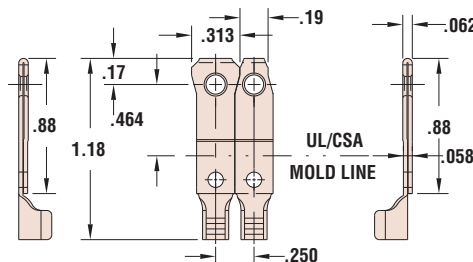

116 Series Polarized

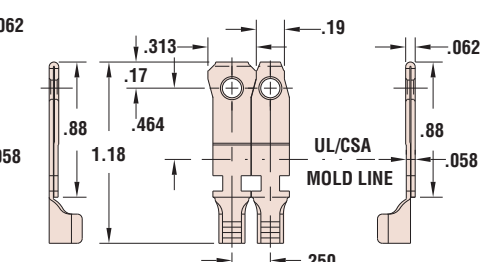

116-N Series Polarized

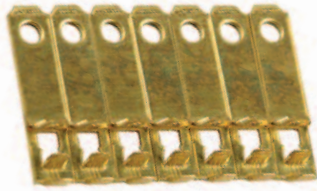

Heyco® Full Thickness Male Blades

For Right Angle Plugs

NEMA 1-15P & 5-15P – .058" Mold Line Thickness

- All **Series 119 and 119-18** Blades feature 90° crimp sections for Right Angle Plugs.
- All **Series 119 and 119-18** Blades feature large flow-through holes below the mold line, for strain relief pull out protection.
- All **Series 119 and 119-18** Blades are front loaded for overmolding.
- **Series 119** Blades feature a larger crimp section for AWG 14-12 gauge conductors.
- **Series 119-18** Blades feature a smaller crimp section for AWG 18-16 gauge conductors.
- Flat Part No. 5706 has no strain relief "knee" resulting in lower material content savings.
- DFARS Compliant

PART DATA			PART NO.		APPLICATION TOOLING*				
Profile	AWG Range	Material	Non-polarized	Polarized	Die**		Feeds	Crimp Punch	Anvil
					For Non-polarized	For Polarized			
119 Series - larger crimp section									
Flat	14-12	Brass Tin-Pl	5700	-	5700SXX5	-	Dual Rear	08A3	07A7
			5749	-	5749SXX5	-			
119-18 Series - smaller crimp section									
Flat w/ Knee	18-16	Brass Tin-Pl	5703	-	5703SXX5	-	Dual Rear	08A4	07A8
			5704	-	5704SXX5	-			
Flat no Knee	18-16	Brass	5706	-	5706SXX5	-			

* "S" in the Die Part No. indicates Heyco Standard Applicator Die; "U" indicates Heyco Universal Applicator Die. These high volume Applicators are designed for 3-5 ton presses - see page 8-59.

** "XX" represents Wire Gauge. Please specify Wire Gauge when ordering.

For Low Profile Flat Plugs

NEMA 1-15P & 5-15P – .060" Mold Line Thickness

PART DATA				PART NO.		APPLICATION TOOLING*				
Profile	Overall Length in.	AWG Range	Material	Non-polarized	Polarized	Die**		Feeds	Crimp Punch	Anvil
						For Non-polarized	For Polarized			
Flat	1.01	18-14	Brass	8021	8023	8021SXX5	8023SXX5	Left to Right Right to Left	0L06, 0L35	0L10
				8020	8022	8020SXX5	8022SXX5			

* Use the Heyco Standard Applicator Die (indicated by "S" in the Die Part No.), page 8-59.

** "XX" represents Wire Gauge. Please specify Wire Gauge when ordering.

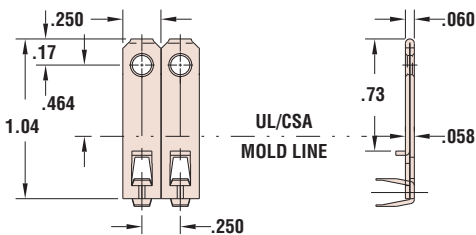

119 Series Non-Polarized

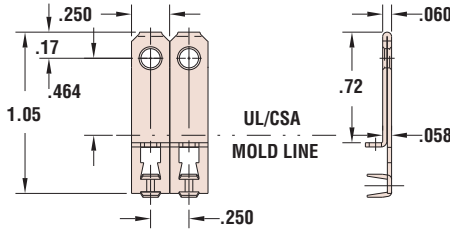

119-18 Series Non-Polarized

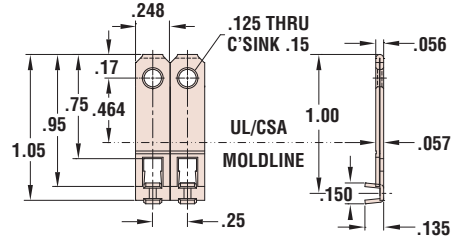

5706

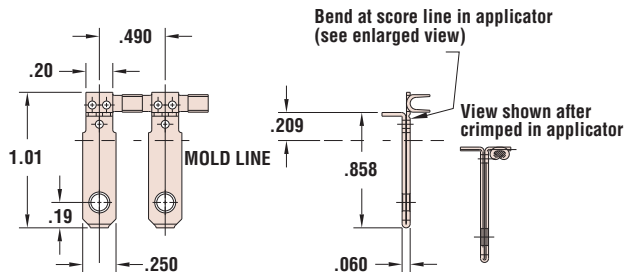

Flat Plug Non-Polarized¹

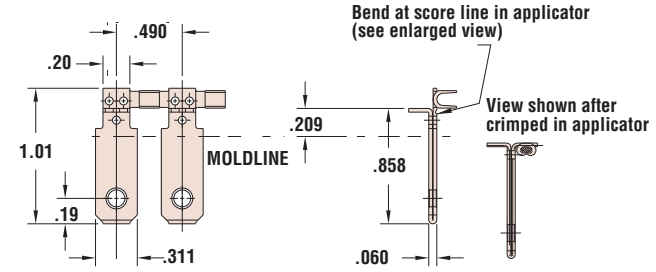

Flat Plug Polarized¹

¹ All Flat Plug Blades are "full wide/full narrow" designed for added support when attached to conductors.

Materials	Alloy 260 Brass (70% Cu, 30% Zn. Higher Cu content resists dezincification) Tin-Pl = Brass, Tin plated before or after stamping
Certifications	Recognized Component under UL File E164169 Certified by the Canadian Standards Association File 91824
Standards	NEMA 1-15P & NEMA 5-15P

Heyco® Full Thickness Male Blades BGB and BGMT Series

Blade-Pin-Blade/Blade-Tab-Pin Strip Sequences

NEMA 1-15P & 5-15P – .058" Mold Line Thickness

One shot, one operator, one die terminating!

For mating Female Cord Connectors, see page 8-50.

For Male Ground Pins, see pages 8-39 & 8-40.

For Full Thickness Male/Female Combination Terminals, see pages 8-55 & 8-56.

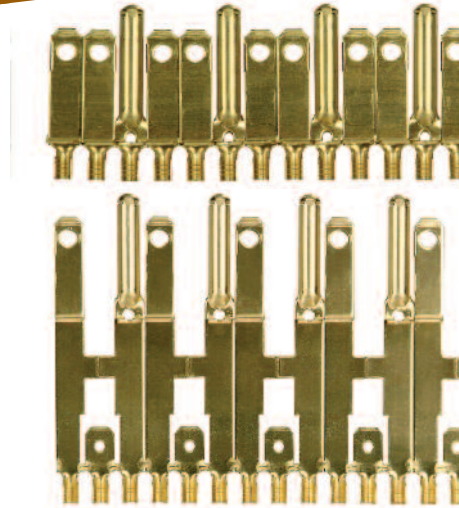

PART DATA			PART NO.		APPLICATION TOOLING*				
Blade Profile	AWG Range	Material	Non-polarized	Polarized	Die**	Feeds	Tool Pack	Crimp Punch	Anvil
BGB Series – Blade-Ground Pin-Blade									
Flat	18-14	Brass Post-Ni	5790	-	5790UXX5	Left to Right	B280L/B281L	C453	C327
			5794	-	5794UXX5				
7-Shape	18-14	Brass Tin-Pl	5792	-	5792UXX5	Right to Left	B280R/B281R		
			5796	-	5796UXX5				
			5793	-	5793UXX5				
alternate tooling for above BGB'S:									
	18						B282L/B283L	C798	C327
	16						B284L/B285L	C799	
	14						B286L/B287L	C800	
BGMT Series – Blade-Male Tab-Ground Pin									
Flat	18-14	Brass	5797	-	Consult Heyco	Left to Right	Consult Heyco		

- BGB and BGMT Series Blades feature (3) components on one reel, allowing the operator to attach all three conductors at once for highly efficient **"3-Up" terminating: one shot, one operator, one die.**
- Flat BGB/BGMT Plug Blades are **front loaded** for overmolding.
- Due to their profile, 7-Shape BGB Blades are **side loaded** for overmolding.
- Both BGB and BGMT feature a **unique folded, double-seam** Ground Pin design.
- DFARS Compliant

7-Shape Blades feature a retention ledge to maintain position during overmolding (mold stop).
 * Use the Heyco Universal Applicator Die (indicated by "U" in the Die Part No.), page 8-59.
 ** "XX" represents Wire Gauge. Please specify Wire Gauge when ordering.

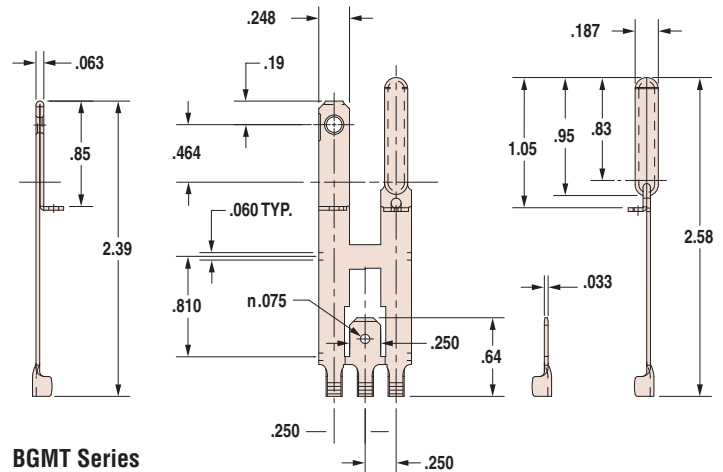
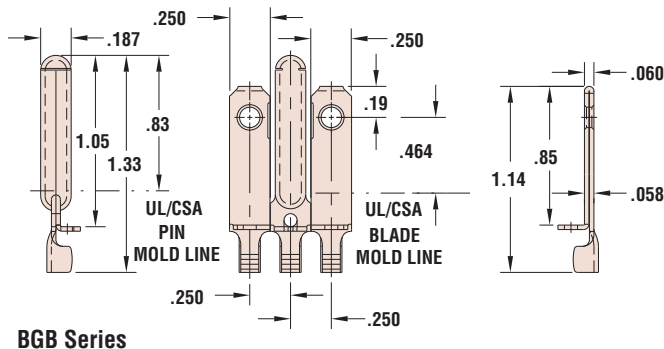

Materials	Alloy 260 Brass (70% Cu, 30% Zn. Higher Cu content resists dezincification) Tin-Pl = Brass, Tin plated before or after stamping Post-Ni = Brass, Nickel plated after stamping
Certifications	Recognized Component under UL File E164169 Certified by the Canadian Standards Association File 91824
Standards	NEMA 1-15P & NEMA 5-15P

Quick Specs

“Stay Connected” with



Power Components

a PennEngineering® Company



Heyco® Hospital Grade Solid Male Blades

NEMA 1-15P & 5-15P – .058" Mold Line Thickness

Used in solder connected applications for “hospital grade” plugs at .057" (1,4 mm) solid brass

- Heyco’s Hospital Grade Line features **solid brass** and **soldered connections** for **increased** strain relief, reliability, and performance.
- DFARS Compliant

Type	PART DATA			PART NO.	Ref Drawing	Feeds
	Overall Length in.	AWG Range	Material			
No Hole	1.31	Solder	Brass	5768	5768	Bulk
Flat	1.31	Solder	Brass Post-Ni	5766 5767	5766	
Angle	1.38	Solder	Brass Post-Ni	5765 5764	5765	

Post plated bright nickel finish available, consult Heyco.

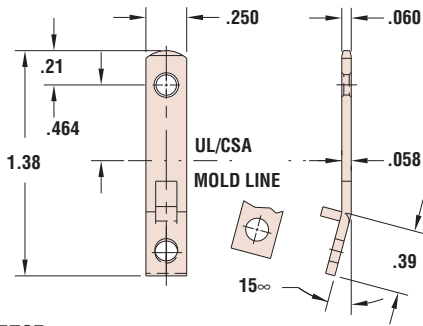

5765

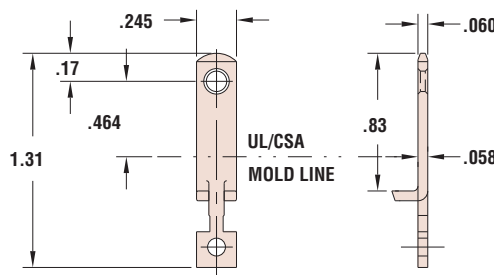

5766

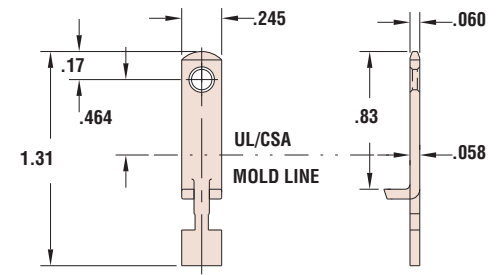

5768



- DFARS Compliant

Heyco® Hospital Grade U-Shape Ground Pins

Type	PART DATA			PART NO.	Ref Drawing	Feeds
	Overall Length in.	AWG Range	Material			
U	1.60	Solder	Brass Post-Ni	5820 5821	5820	Bulk

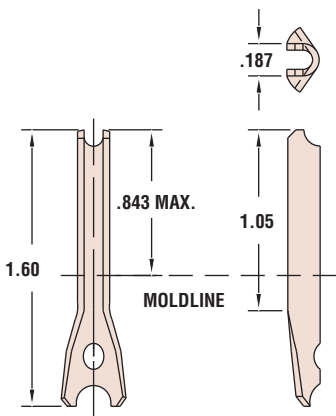

5820

8-35

Materials Alloy 260 Brass (70% Cu, 30% Zn. Higher Cu content resists dezincification)
Post-Ni = Brass, Nickel plated after stamping

“Stay Connected” with



Power Components

a PennEngineering® Company

Heyco® Plug-In Device Contacts

Type	PART DATA			PART NO.		Feeds
	Overall Length in.	AWG Range	Material	Non-polarized	Polarized	
Flat	1.00	Solder	Brass	8063	-	Left to Right
	.80	Solder	Brass	8178	-	
Flat	1.00	Solder	Brass	5029†	5031†	Bulk
				5030††	-	
	1.03	Solder	Brass	8179*	-	
Spring	1.28	Solder	Brass	5021	-	
Flat	1.30	Solder	Brass	8172	-	
				8191†††	-	
	1.97	Solder	Brass	8192	-	

NEW!

† Part Nos. 5029 and 5031 must be ordered together.

†† Part No. 5030 has straight sides

††† No hole.

*Part No. 8179 for .078" Max PCB Thickness

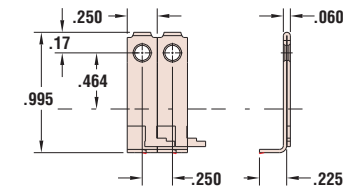

8063

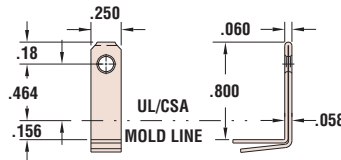

8178

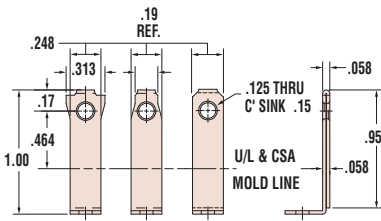

5031/5029, 5030

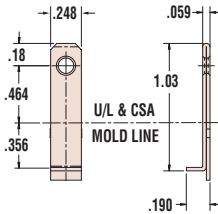

8179

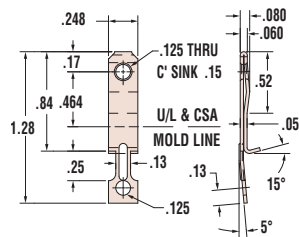

5021

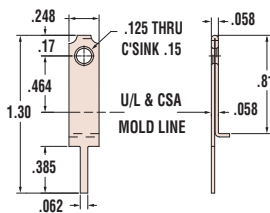

8172

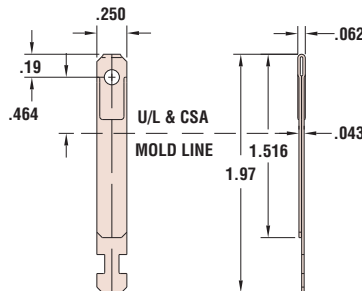

8191/8192



- **Designed for cordless OEM products** that plug directly into an electrical outlet:
 - Plug-in Transformers
 - Plug-in Electronic Power Supplies
 - Plug-in Electronic Enclosures
 - Plug-in Rodent and Other Pest Control Devices
 - Plug-in Air Fresheners and Insect Repellents
 - Plug-in Smoke and Carbon Monoxide Sensors and Alarms
 - Plug-in Timers
 - Plug-in Night Lights
- Plug-In Contacts are not UL or CSA approved.
- DFARS Compliant

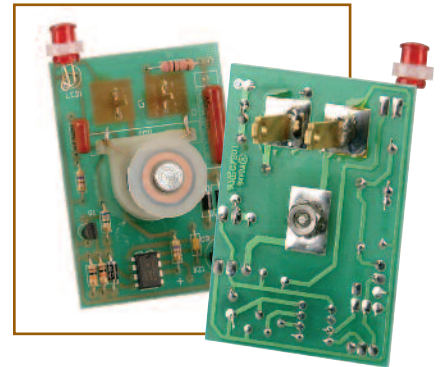

Material

Alloy 260 Brass (70% Cu, 30% Zn. Higher Cu content resists dezincification)

Quick Specs



- Lowest profile - suitable for LED printed circuit boards.
- Nominal voltage according to EN 60598-1:
1-Pole - 600V
2-Pole - 250V
- Nominal current - 6 Amps.
- Clamping Range for both solid and flexible conductors:
24-18 AWG (0,20-0,75 mm²).
- Wire stripping length .315-.354" (8-9 mm).
- Maximum ambient temperature - 220°F (105°C).
- Insulation distances must be considered in the specific application.
- For Heyco's complete line of LED spacers see pages 7-32 and 7-33.

Heyco® Surface Mount Miniature Connectors

AWG	WIRE		AMPS North America	POLES	PART NO. White	DESCRIPTION	Pieces per Coil	Coils per Box
	Size	Type						
SMMC Series								
24	0,20-	Solid or	6	1	4320	SMMC-1	2000	10
18	0,75	Flexible		2	4321	SMMC-2	1500	
SMMC Release Pin Tool					0995	SMMC-T		

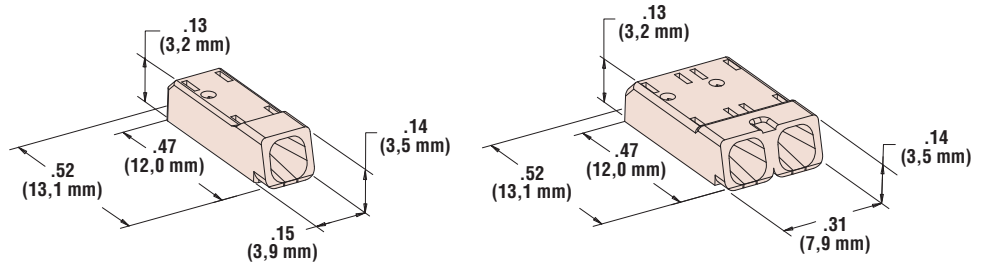

Openings for release of wires with Release Pin Tool #0995

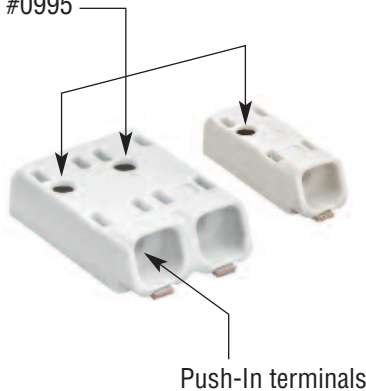

Recommended Printed Circuit Board Configuration

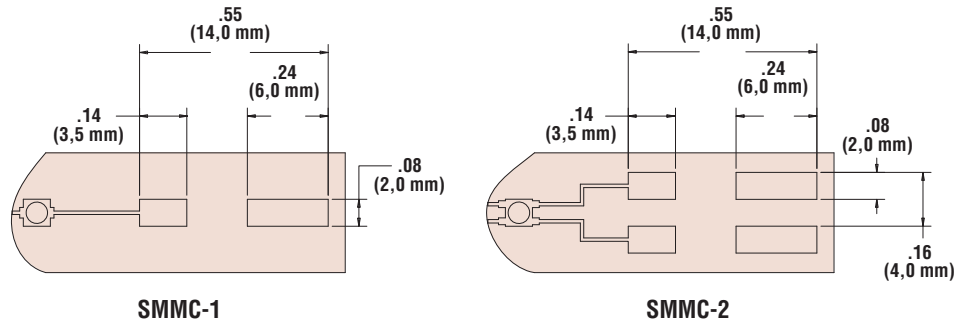

Quick Specs

Material Certifications



GF Nylon 6/6
Recognized under Components Program of Underwriters' Laboratories to both Canadian and US Requirements File E467283

Flammability Rating
Temperature Range

94V-0
-4°F (-18°C) to 248°F (120°C)

“Stay Connected” with



Power Components

a PennEngineering® Company



Heyco® PCB Contacts

PCB Blade, Pins, and Female Connectors

Type	PART DATA				Material	PART NO.		FEEDS
	Dimensions		For Maximum PCB Thickness			Non-polarized	Polarized	
	in.	mm.	in.	mm.				
Blades								
Length								
Snap-thru	.847	21,5	.047	1,2	Brass	5200	5201	Bulk
	1.030	26,1	.078	2,0	Brass	8179	—	
Pins*								
Diameter								
Snap-Thru	.187	4,7	.047	1,2	Brass	5940	—	Bulk
Solder	.187	4,7	.047	1,2	Brass	5907	—	Bulk
Right Angle	.125	3,2	.047	1,2	Tin-Pl	8050	—	Bulk
Female								
Length								
Female	1.080	27,4	Rivet Mount†		Brass	7347	—	Bulk
1155-90 Female**								
Wiping Contact 90°	.790	20,6	.047	1,2	Brass	7261	—	Bulk

NEW!

NEW!

- Designed for printed circuit board applications when **connection to AC power is required**.
- Can be used for either NEMA 1-15 or 5-15 applications.
- **Part Nos. 5200 and 5201** are full wide designed for added support when attached to the printed circuit board.
- For our complete line of stamped Power Components, see Section 8.
- For our complete line of Nylon PCB Supports, see section 7.
- DFARS Compliant

*For additional Heyco Specialty Pins, see page 8-42.

**For additional Heyco Female Cord Connectors, see page 8-50.

† .160" (4,1 mm) mounting hole.

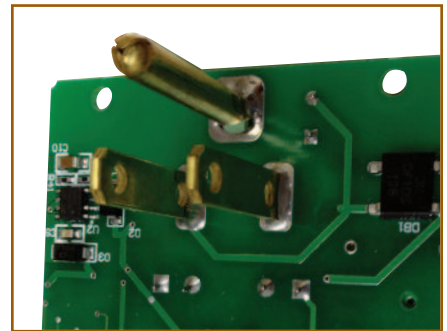
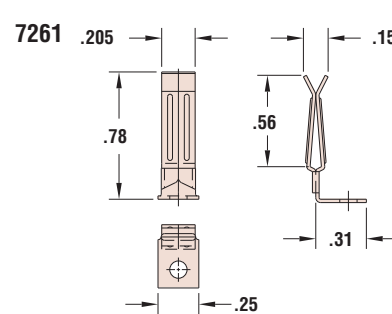
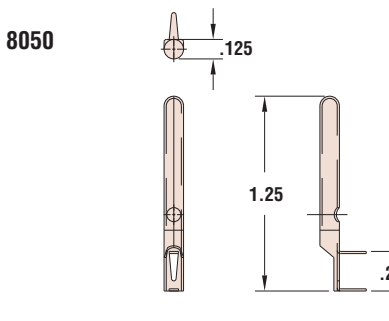
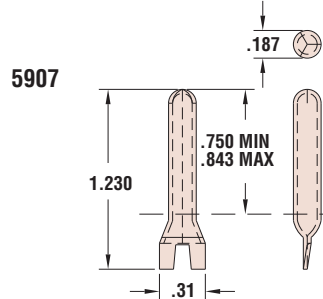
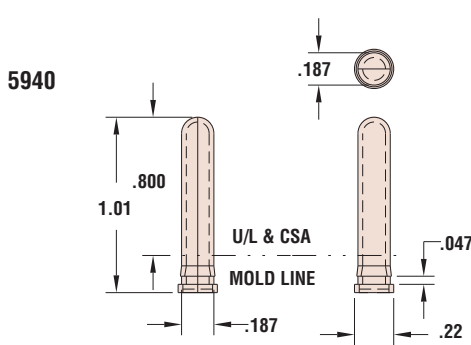
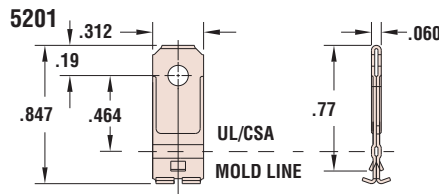
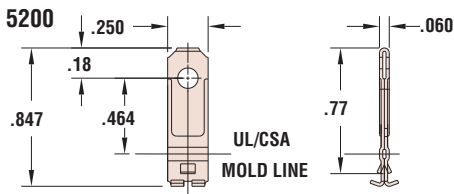

Materials

Alloy 260 Brass (70% Cu, 30% Zn)
Tin-Pl = Brass, Tin plated before or after stamping

*Quick
Specs*



Heyco® .187" Diameter Ground Pins - Male

For Heyco Padded and Full Thickness Blades, see pages 8-29 thru 8-34

All Series:

- **187" (4,7 mm)** Outside Diameter.
- Conductor crimp ears only.
- Available only in continuous strip form except **Part No. 5877** available Bulk only.
- Overall length options of 1.25" (31,8 mm), 1.35" (34,3 mm), and 1.37" (34,8 mm).
- **Series 186 and 186-L** feature a 90° "knee" section for **strain relief** and assembly orientation.
- DFARS Compliant

Overall Length in.	PART DATA		PART NO.	Die**	APPLICATION TOOLING*			Crimp Punch	Anvil
	AWG Range	Material			Feeds	Tool Packs			
188 Series									
1.35	18-12	Brass	5922	5922UXX5	Left to Right	B362L/B363L	C360	C629	
		Tin-Pl	5921	5921UXX5					
		Brass	5923	5923UXX5	Right to Left	B362R/B363R	C360	C365	
		Tin-Pl	5924	5924UXX5					
186 Series									
1.25	18-14	Brass	5877	-	Bulk	-	-	-	
		Brass	5879	5879UXX5					Left to Right
	Tin-Pl	5883	5883UXX5	Right to Left	B360R/B361R				
	Brass	5880	5880UXX5						
	14-10	Brass	5881	5881UXX5					
186-L Series									
1.37	18-14	Brass	5889	5889UXX5	Left to Right	B360L/ B361L	C001	C009	
	14-10	Brass	5888	5888UXX5					
	18-14	Brass	5886	5886UXX5	Right to Left	B360R/B361R			
	Tin-Pl	5887	5887UXX5						
14-10	Brass	5884	5884UXX5						
	Tin-Pl	5885	5885UXX5						

* Heyco high volume Application Tooling, designed for 3-5 ton presses - see page 8-59.
 Heyco Mini Applicators, designed for 1.5-3 ton bench top presses, are available - see page 8-59.
 ** "XX" represents Wire Gauge. Please specify Wire Gauge when ordering.

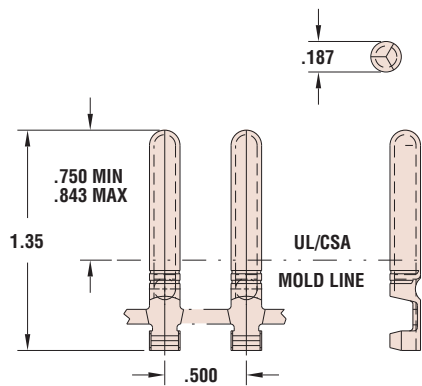

188 Series

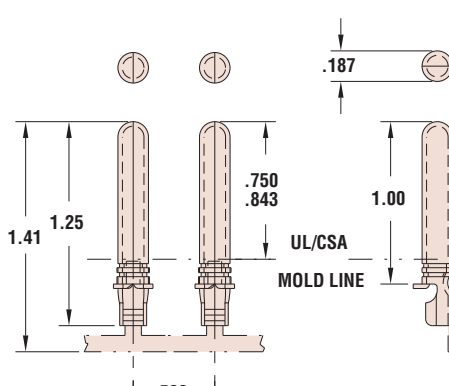

186 Series

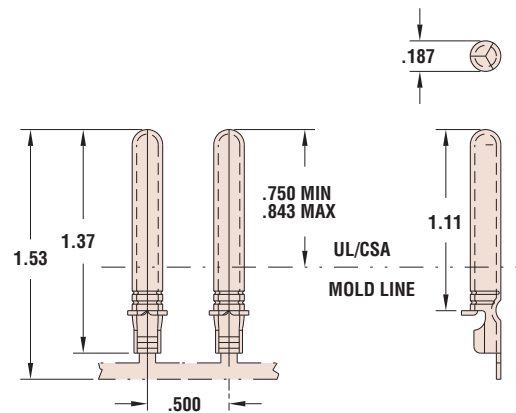

186-L Series

Quick Specs

Materials

Alloy 260 Brass (70% Cu, 30% Zn. Higher Cu content resists dezincification)
 Tin-Pl = Brass, Tin plated before or after stamping

Heyco® .187" Diameter Ground Pins – Male Right Angle

90° crimp section designed for Right Angle Plugs

See pages 8-29 thru 8-34 for Heyco Padded and Full Thickness Blades



Overall Length in.	PART DATA		PART NO.	APPLICATION TOOLING*				
	AWG Range	Material		Die**	Feeds	Tool Packs	Crimp Punch	Anvil
187 Series								
1.34	20-18	Brass Tin-Pl	5913 5915	5913SXX5 5915SXX5	Rear Rear, L-R	-	0J48	0J49
	16-12	Brass Tin-Pl	5900 5901	-	Rear	-	088A	097A
Solid U Shape								
.82	18-16	Brass	8013	-	Bulk			

Male Right Angle Pins - 187 Series

- Feature .187" (4,7 mm) Pin diameter.
- Parts differentiate by **flag type crimp** size and thus accommodate AWG 20-18 conductors and AWG 16-12 conductors.
- DFARS Compliant

Male Right Angle Pin - Solid U Shape

- Feature .187" (4,7 mm) Pin diameter.
- Shorter part, accommodates 18-16 AWG conductors.
- Available in bulk form only.
- DFARS Compliant

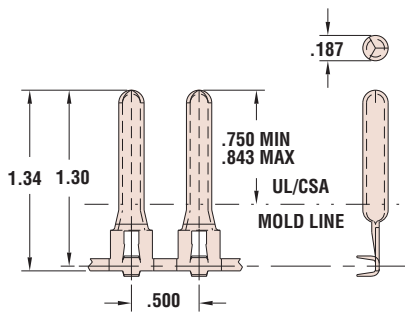

187 Series 20-18 AWG

8013

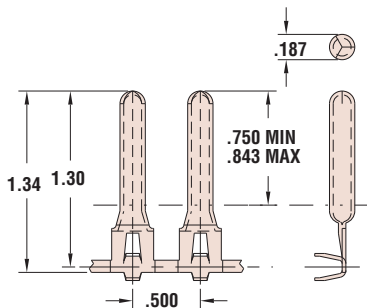
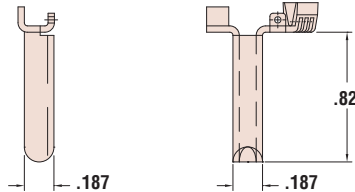
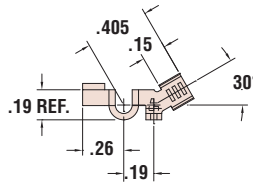

187 Series 16-12 AWG

Materials

Alloy 260 Brass (70% Cu, 30% Zn. Higher Cu content resists dezincification)

Tin-Pl = Brass, Tin plated before or after stamping

Quick
Specs



Heyco® .187" Diameter Ground Pins – Female

D-Shape Barrel designed for .187" (4,7 mm) O.D. Mating Pin

Female Ground Pins

- **All Series:** D-Shaped Barrel for more secure connection with a .187" (4,7 mm) mating Male Pin.
- **1550 Series** have an offset “high” crimp, providing an extremely short barrel and allowing for complete mating Male Pin pass through.
- **1500 and 1530 Series** crimps are standard or in line with the Pin section; they differentiate on crimp size only.
- **1526 Series** parts are terminal lug/ground connectors designed for circuit boards or “3 to 2” wire grounding adapters or converters. For use with **1186 and 1189 Series** Combination Terminals, pages 8-55 and 8-57.
- DFARS Compliant

Overall Length in.	PART DATA		PART NO.	APPLICATION TOOLING*				Crimp Punch	Anvil
	AWG Range	Material		Die**	Feeds	Tool Packs			
1550 Series									
.66	18-14	Brass	7344	7344UXX5	L to R	B592L/B593L	C484	C488	
1500 Series									
1.13	18-16	Brass	7339	7339UXX5	Left to Right	B590L/B591L	C388	C391	
		Tin-Pl	7340	7340UXX5					
1.13	14-10	Brass	7342	7342UXX5	R to L	B590R/B591R			
		Tin-Pl	7341	7341UXX5	Left to Right	B590L/B591L	C388	C391	
Brass	7346	7346UXX5	R to L	B590R/B591R					
1530 Series									
1.13	14-10	Brass	7341	7341UXX5	Left to Right	B590L/B591L	C388	C391	
		Tin-Pl	7346	7346UXX5	R to L	B590R/B591R			
1526 Series									
1.08	-	Brass	7347	-	Bulk	-	-	-	

* Heyco high volume Application Tooling, designed for 3-5 ton presses - see page 8-59.
 Heyco Mini Applicators, designed for 1.5-3 ton bench top presses, are available - see page 8-59.
 ** “XX” represents Wire Gauge. Please specify Wire Gauge when ordering.

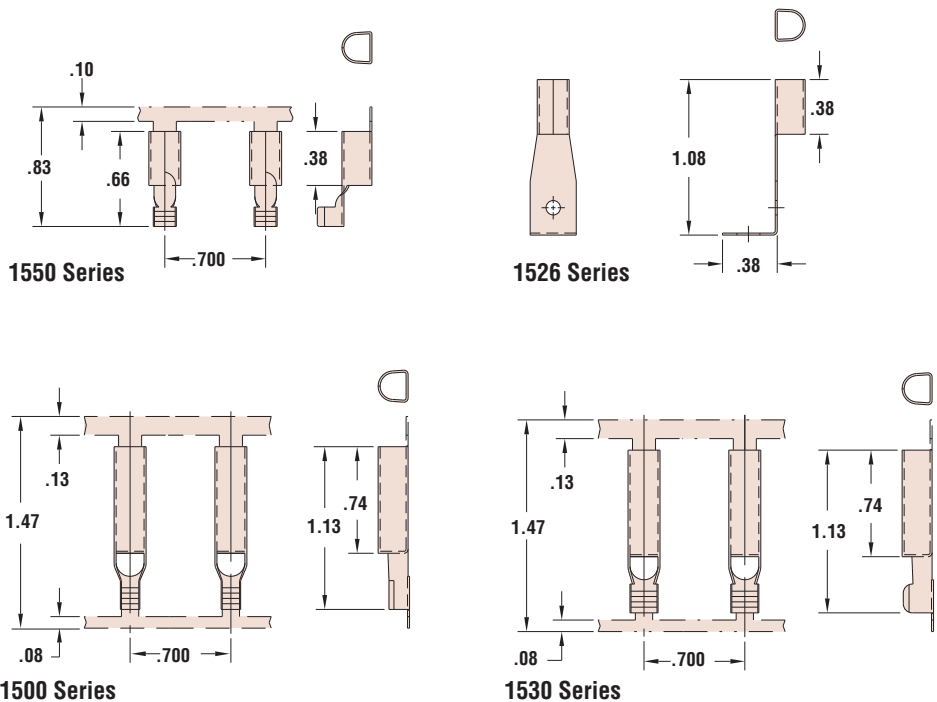

Quick Specs

Materials

Alloy 260 Brass (70% Cu, 30% Zn. Higher Cu content resists dezincification)
 Tin-Pl = Brass, Tin plated before or after stamping

“Stay Connected” with



Power Components

a PennEngineering® Company

Heyco® Specialty Pins

Overall Length in.	Dia. in.	PART DATA			PART NO.	APPLICATION TOOLING*				
		Type	AWG Range	Material		Die**	Feeds	Tool Packs	Crimp Punch	Anvil
PCB†										
1.01	.187	Snap-thru	-	Brass	5940	-	Bulk	-	-	-
1.23	.187	Solder	-	Brass	5907					
1.25	.125	90°	-	Tin-PI	8050					
Electric Blanket										
1.59	.125	-	26-18	Brass	7086	7086UXX5	Left to Right	B310L/B311L	C436	C440
Medical Pins-Ribs										
1.23	.178	IDC - 3	28-24	Brass	8034	8034UXX5	Left to Right	B968L/B969L	C706	C705
1.19	.178	VE - 3	26-22	Brass	8032	8032UXX5	Left to Right	B900L/B901L	C143	C147
			26-30	Post-Ni	8033	8033UXX5				
		AL - 3	26-22	Post-Ni	8036	8036UXX5				
		WB - 4	26-22	Brass	8030	8030UXX5				

* Heyco high volume Application Tooling, designed for 3-5 ton presses - see page 8-59.

Heyco Mini Applicators, designed for 1.5-3 ton bench top presses, are available - see page 8-59.

** “XX” represents Wire Gauge. Please specify Wire Gauge when ordering.

† For additional PCB Contacts, see page 8-38.



- PCB pins designed for use with circuit boards.
- **Medical Pins** feature insulation crimp and dimples on barrel for added strain relief and better contact.
- DFARS Compliant

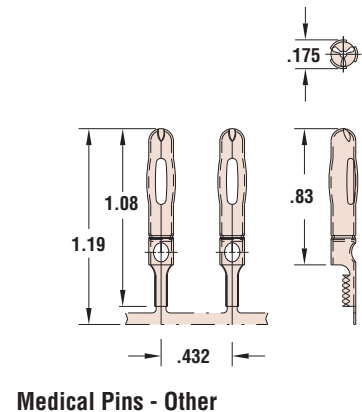
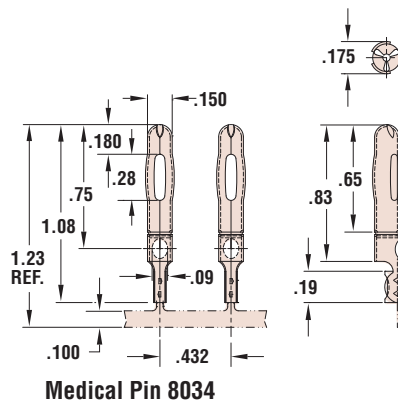
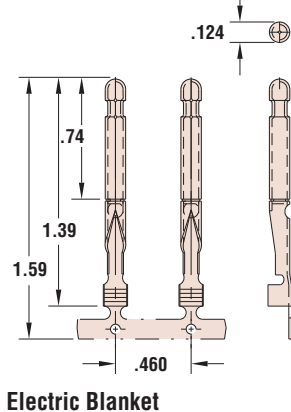
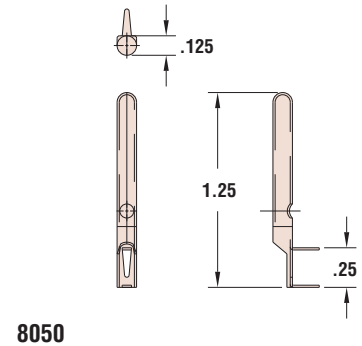
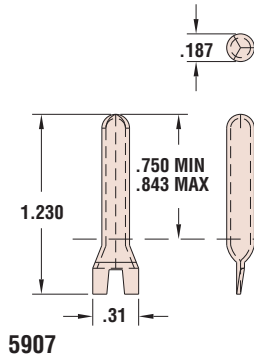
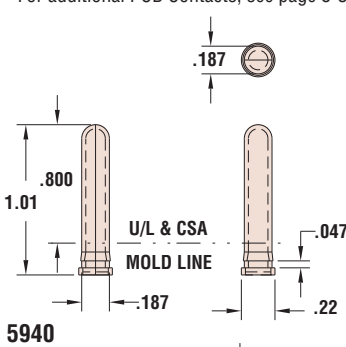

Materials

Alloy 260 Brass (70% Cu, 30% Zn. Higher Cu content resists dezincification)
 Tin-PI = Brass, Tin plated before or after stamping
 Post-Ni = Brass, Nickel plated after stamping

*Quick
Specs*



Heyco® Heavy Duty Ground Pins – Male

For Heavy Duty Blades, see pages 8-27 & 8-28

Both Series:

- Suitable for use in straight and right angle plugs.
- On termination, the strip and crimping die bends Angled Shape parts to 90°.
- All 250 and 312 Series are compatible with Heyco Heavy Duty Blades.
- DFARS Compliant

250 Series:

- a.k.a. "Travel Trailer" Grounding Pin.
- 30 Amp rating.
- Conductor crimp ears only.
- DFARS Compliant

312 Series:

- Heavy Duty Grounding Pin.
- 30, 50 and 60 Amp rating.
- Conductor crimp ears only.
- DFARS Compliant

Overall Length in.	PART DATA			PART NO.	APPLICATION TOOLING*					
	Shape	AWG Range	Material		Die**	Feeds	Tool Packs	Crimp Punch	Anvil	
250 Series - .250" (6,4 mm) outside diameter										
1.88	Angled	14-10	Brass	5930	5930SXX5	Bulk	-	OB51	OB52	
	Flat	14-10	Tin-Pl	5931	5931SXX5					
1.91	Flat	14-10	Brass Brass	5933 5932	5933UXX5 5932UXX5	Left to Right Right to Left	-	C901	0892	
312 Series - .312" (7,9 mm) outside diameter										
2.48	Angled	10-6	Brass	6249	6249SXX5	Bulk	-	OB51	OB53	
			Tin-Pl	6250	6250SXX5					
			Post-Ni	6251	6251SXX5					

* Use the Heyco Universal Applicator Die (indicated by "S" or "U" n the Die Part No.), page 8-59.
 ** "XX" represents Wire Gauge. Please specify Wire Gauge when ordering.

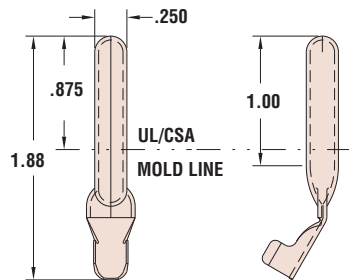

250 Series Angled

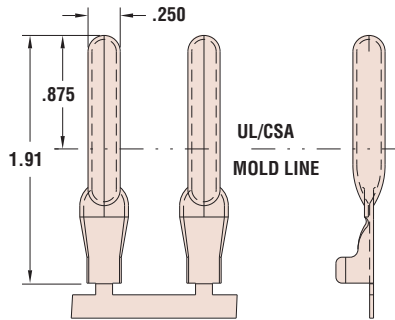

250 Series Flat

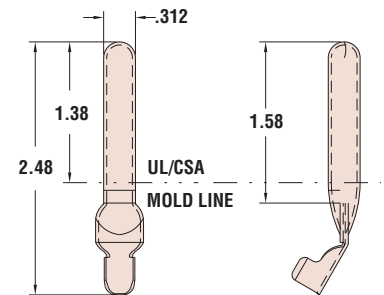

312 Series

Quick Specs

Materials

Alloy 260 Brass (70% Cu, 30% Zn. Higher Cu content resists dezincification)
 Tin-Pl = Brass, Tin plated before or after stamping
 Post-Ni = Brass, Nickel plated after stamping

Heyco® Heavy Duty Ground Pins – Female

For Heavy Duty Blades, see pages 8-27 & 8-28

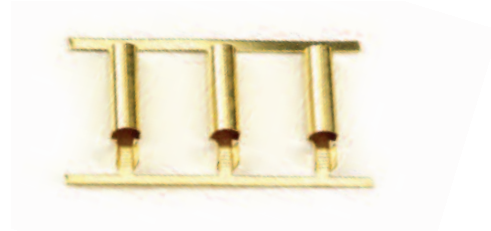

Overall Length in.	PART DATA			PART NO.	APPLICATION TOOLING*				
	Shape	AWG Range	Material		Die**	Feeds	Tool Packs	Crimp Punch	Anvil
250 Series - designed to mate with .250" (6,4 mm) outside diameter Heavy Duty Male Pins									
1.18	D	14-10	Brass	8243	8243UXX5	Left to Right	B966L/B967L	C388	C391
1.22	O	10-6	Tin-Pl	8246	8246UXX5	Left to Right	B974L/B975L		
1.72	O	10-6	Tin-Pl	8245	8245UXX5	Left to Right	B952L/B953L	C640	C647
	D	10-6	Brass	8244	8244UXX5				

- Specify **D-shaped Barrel** parts for the most secure connection.
- DFARS Compliant

* Use the Heyco Universal Applicator Die (indicated by “U” in the Die Part No.), page 8-59.

** “XX” represents Wire Gauge. Please specify Wire Gauge when ordering.

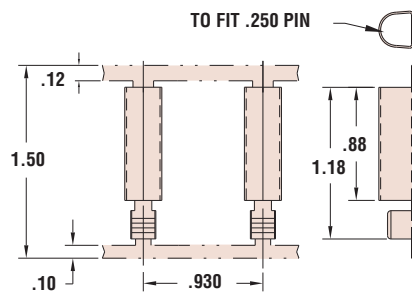

8243

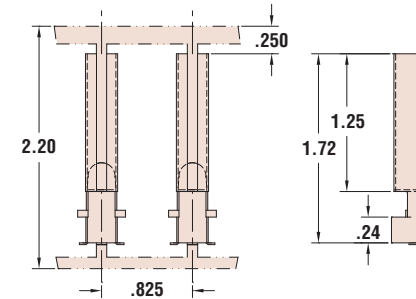

8244

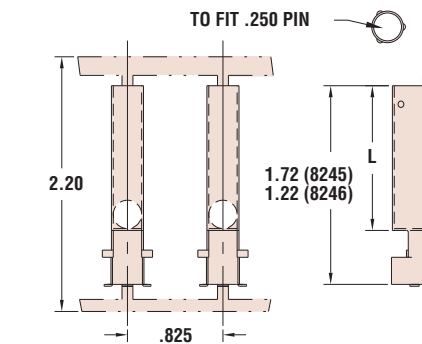

8245

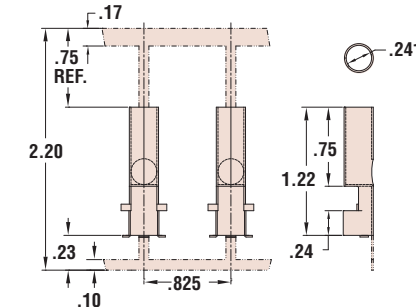

8246

Materials

Alloy 260 Brass (70% Cu, 30% Zn. Higher Cu content resists dezincification)
 Tin-Pl = Brass, Tin plated before or after stamping
 Post-Ni = Brass, Nickel plated after stamping

Quick Specs



Now Available
in Single Reel
Order Quantities!

Heyco® Male Pins

For mating Female Pin & Connectors, see pages 8-47 thru 8-49

- Wide range of diameter and length combinations for 20 to 10 AWG conductors.
- Folded Pin design saves material, **reduces cost.**
- Hole behind crimp provides added **strain relief**, or can be cut-off on Assembly Equipment.
- Conductor crimp ears only.
- Available only in continuous strip form, regular (left to right) wind.
- DFARS Compliant

MP075 Series

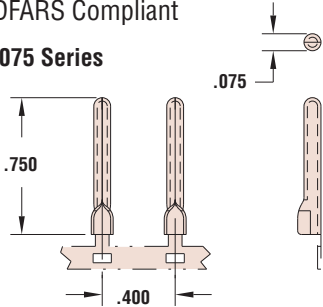

MP089 Series

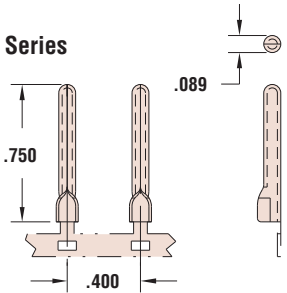

MP093 Series

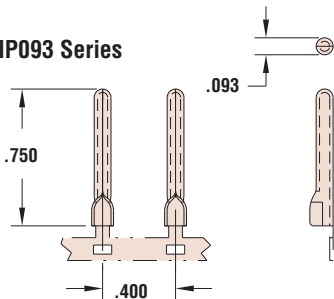

Dia. in.	PART DATA			PART NO.	APPLICATION TOOLING*					
	Overall Length in.	AWG Range	Material		Die**	Feeds	Tool Packs	Crimp Punch	Anvil	
MP075 Series										
.075	1.00	20-18	Brass	7010	7010UXX5	Left to Right	B300L/B301L	C229	C231	
MP089 Series										
.089	.75	20-18	Brass	7012	7012UXX5	Left to Right	B300L/B301L	C229	C231	
			Tin-Pl	7013	7013UXX5					
			Post-Silver	7011	7011UXX5					
MP093 Series										
.093	.63	20-18	Brass	7002	7002UXX5	Left to Right	B300L/B301L	C229	C231	
			Tin-Pl	7003	7003UXX5					
			Tin-Pl	7001	7001UXX5					
			Tin-Pl	7004	7004UXX5					
.093	.75	20-18	Brass	7008	7008UXX5	Left to Right	B304L/B305L	C230	C232	
			Tin-Pl	7009	7009UXX5					
MP109 Series										
.109	.63	20-18	Brass	7032	7032UXX5	Left to Right	B300L/B301L	C229	C231	
			Tin-Pl	7033	7033UXX5					
			Brass	7030	7030UXX5					
	Tin-Pl	7031	7031UXX5							
	.109	1.00	20-18	Brass	7034					7034UXX5
				Tin-Pl	7035					7035UXX5
Brass				7049	7049UXX5					
.109	.63	16-14	Tin-Pl	7050	7050UXX5	Left to Right	B304L/B305L	C230	C232	
			Brass	7047	7047UXX5					
.109	.75	16-14	Tin-Pl	7048	7048UXX5	Left to Right	B304L/B305L	C230	C232	
			Brass	7048	7048UXX5					
MP122 Series										
.122	1.00	16-14	Tin-Pl	7055	7055UXX5	Left to Right	B304L/B305L	C230	C232	

* Heyco high volume Application Tooling, designed for 3-5 ton presses - see page 8-59.
 Heyco Mini Applicators, designed for 1.5-3 ton bench top presses, are available - see page 8-59.
 ** "XX" represents Wire Gauge. Please specify Wire Gauge when ordering.

MP109 Series

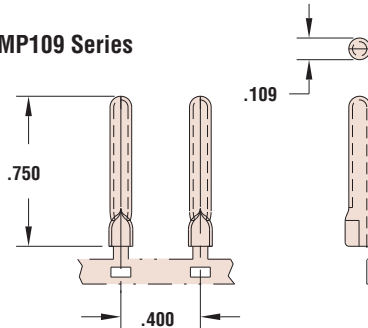

MP122 Series

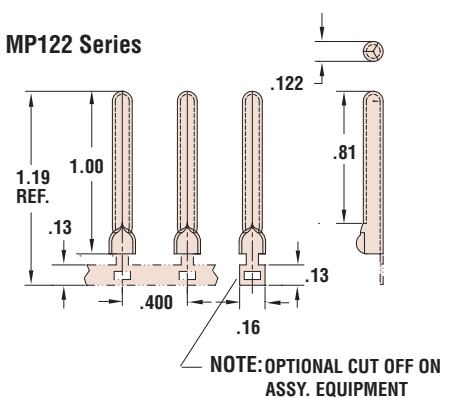

Quick
Specs

Materials

Alloy 260 Brass (70% Cu, 30% Zn. Higher Cu content resists dezincification)
 Tin-Pl = Brass, Tin plated before or after stamping
 Post-Ni = Brass, Nickel plated after stamping

“Stay Connected” with



Power Components

a PennEngineering® Company

Now Available
in Single Reel
Order Quantities!



Heyco® Male Pins

For mating Female Pin & Connectors, see pages 8-47 thru 8-49

Dia. in.	PART DATA			PART NO.		APPLICATION TOOLING*				
	Overall Length in.	AWG Range	Material		Die**	Feeds	Tool Packs	Crimp Punch	Anvil	
MP125 Series										
.125	.63	20-18	Brass	7062	7062UXX5	Left to Right	B300L/B301L	C229	C231	
	.75	20-18	Brass Tin-PI	7060 7061	7060UXX5 7061UXX5					
	1.00	20-18	Brass Tin-PI	7064 7065	7064UXX5 7065UXX5					
	.75	16-14	Brass Tin-PI	7068 7069	7068UXX5 7069UXX5	Left to Right	B304L/B305L	C230	C232	
	1.00	16-14	Tin-PI Tin-PI	7073 7076†	7073UXX5 7076UXX5					
MP141 Series										
.141	1.03	18-16	Brass	7171	7171UXX5	Left to Right	B340L/B341L	C135	C138	
MP156 Series										
.156	1.03	18-16	Brass Tin-PI	7181 7183	7181UXX5 7183UXX5	Left to Right	B340L/B341L	C135	C138	
	1.31	18-16	Brass	7180	7180UXX5					
MP178 Series										
.178	1.39	18-14	Brass	7194	7194UXX5	Right to Left	B360R/B361R	C001	C009	
			Tin-PI	7195	7195UXX5					
		12-10	Brass Tin-PI	7192 7193	7192UXX5 7193UXX5					

* Heyco high volume Application Tooling, designed for 3-5 ton presses - see page 8-59.
 Heyco Mini Applicators, designed for 1.5-3 ton bench top presses, are available - see page 8-59.
 ** “XX” represents Wire Gauge. Please specify Wire Gauge when ordering.
 † Split on seam: pin will flex closed when in contact for a stronger connection.

• DFARS Compliant

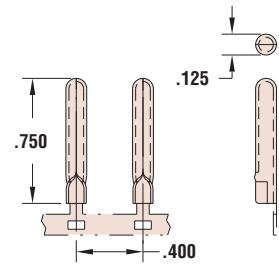

MP125 Series

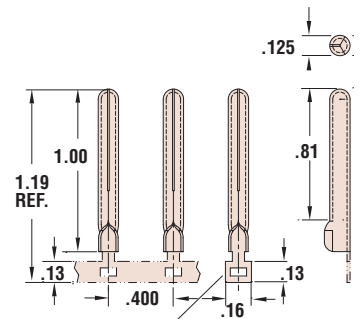

NOTE: OPTIONAL CUT OFF ON ASSY. EQUIPMENT

MP125 Series 7076

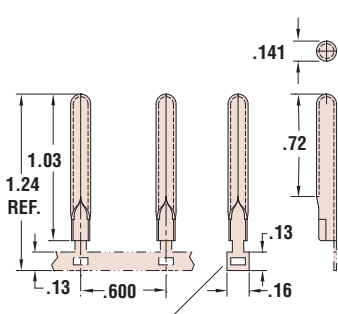

NOTE: OPTIONAL CUT OFF ON ASSY. EQUIPMENT

MP141 Series

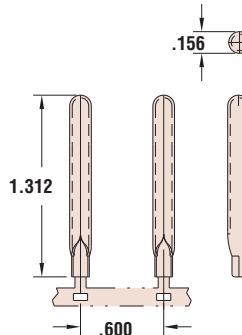

MP156 Series

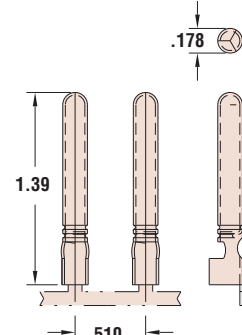

MP178 Series

Materials

Alloy 260 Brass (70% Cu, 30% Zn. Higher Cu content resists dezincification)
 Tin-PI = Brass, Tin plated before or after stamping

Quick
Specs

Now Available
in Single Reel
Order Quantities!



Heyco® Female Pin Connectors

Round Barrel

For mating Male Pins, see pages 8-45 & 8-46
For Female Ground Pins, see pages 8-41 & 8-44

TVR Series

- .56" (14,2 mm) Overall Length.
- .31" (7,9 mm) Round Barrel Length.
- Wide inside diameter range: from .077" (2,0 mm) to .151" (3,8 mm).
- 1/4" (6,4 mm) spacing between connectors for quick, easy attachment.
- Conductor crimp ears only.
- Available only in continuous strip form, regular (left to right) wind.
- DFARS Compliant

SC Series

- .63" (16,0 mm) Overall Length.
- .28" (7,1 mm) Round Barrel Length.
- 1/4" (6,4 mm) spacing between connectors for quick, easy attachment.
- Conductor crimp ears only.
- Available only in continuous strip form, regular (left to right) wind.
- SC Series not CSA certified
- DFARS Compliant

1200 Series

- .56" (14,2 mm) Overall Length.
- D-Shape Barrel with "trap door".
- .109" (2,8 mm) mating Pin diameter for all Part Nos. in Series 1200.
- Mold with D-Shape load pin.
- 1/4" (6,4 mm) spacing between connectors for quick, easy attachment.
- Conductor crimp ears only.
- Available only in continuous strip form, regular (left to right) wind.
- 1200 Series not CSA certified.
- DFARS Compliant

Inside Dia. in.	PART DATA		PART NO.	Die**	APPLICATION TOOLING*			Crimp Punch	Anvil
	AWG Range	Material			Feeds	Tool Packs			
TVR Series - .560" Overall Length									
.077	14-18	Brass	7333 [†]	7333UXX5	Left to Right	B502L/B503L	C180	C181	
.089	14-18	Brass	7319	7319UXX5					
.091, .122	14-18	Brass Tin-PI	7301 7298 [†]	7301UXX5 7298UXX5					
.091	14-18	Brass Tin-PI	7300 7299 [†]	7300UXX5 7299UXX5					
.093	14-18	Brass	7335	7335UXX5					
.105	14-18	Brass Tin-PI	7304 7311 [†]	7304UXX5 7311UXX5					
.107	14-18	Brass	7305 [†]	7305UXX5					
.111	14-18	Brass	7308	7308UXX5					
.122	14-18	Brass	7307	7307UXX5					
.131	14-18	Brass	7315	7315UXX5					
.138, .091	14-18	Brass	7318 7302	7318UXX5 7302UXX5					
.151	14-18	Brass	7303	7303UXX5					
SC Series - .630" Overall Length[†]									
.080	26-22	Tin-PI	7668	7668UXX5	Left to Right	B530L/B531L	C449	C450	
.091	26-22	Brass	7670	7670UXX5					
		Tin-PI Post-Ni	7672 7671	7672UXX5 7671UXX5					
1200 Series - .560" Overall Length[†]									
.103	14-18	Brass	7270	7270UXX5	Left to Right	B502L/B503L	C180	C181	
.105	14-18	Brass Tin-PI	7283 7284	7283UXX5 7284UXX5					
	14-12	Brass	7267	7267UXX5					
.111	14-18	Brass	7291	7291UXX5					

* Heyco high volume Application Tooling, designed for 3-5 ton presses - see page 8-59.
Heyco Mini Applicators, designed for 1.5-3 ton bench top presses, are available - see page 8-59.
** "XX" represents Wire Gauge. Please specify Wire Gauge when ordering.
[†] Not CSA certified.

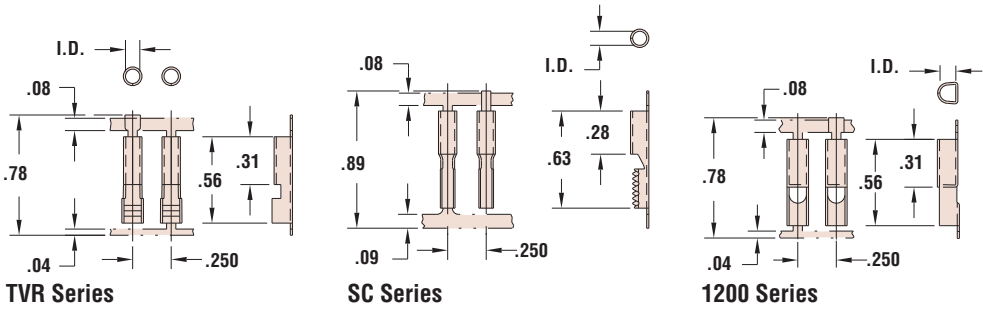

Quick
Specs

Materials	Alloy 260 Brass (70% Cu, 30% Zn. Higher Cu content resists dezincification) Tin-PI = Brass, Tin plated before or after stamping Post-Ni = Brass, Nickel plated after stamping
Certifications	Certified by the Canadian Standards Association File 91824

Heyco® Female Pin Connectors

Round Barrel with Insulation Crimp

For mating Male Pins, see pages 8-45 & 8-46

For Female Ground Pins, see pages 8-41 & 8-44

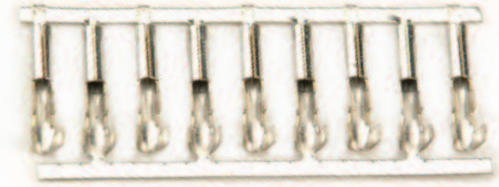

Inside Dia. in.	PART DATA		PART NO.	APPLICATION TOOLING*			Crimp Punch	Anvil
	AWG Range	Material		Die**	Feeds	Tool Packs		
FE Series - .630" Overall Length								
.060	20-18	Brass	7382	7382UXX5	Left to Right	B514L/B515L	C185	C189
		Tin-Pl	7383	7383UXX5				
		Post-Ni	7385	7385UXX5				
.062	20-18	Brass	7370†	7370UXX5				
		Brass Tin-Pl	7386† 7389†	7386UXX5 7389UXX5				
.067	20-18	Brass	7387	7387UXX5				
.070	20-18	Tin-Pl	7379	7379UXX5				
.072	20-18	Tin-Pl	7381	7381UXX5				
.074	20-18	Brass	7393	7393UXX5				
.078	20-18	Brass	7369	7369UXX5				
.079	20-18	Tin-Pl	7371†	7371UXX5				
	20-18	Tin-Pl	7372	7372UXX5				
.082	20-18	Tin-Pl	7378	7378UXX5				
.088	20-18	Brass	7400	7400UXX5				
.091	20-18	Brass	7395	7395UXX5				
		Tin-Pl	7380	7380UXX5				
.093	20-18	Brass	7384	7384UXX5				
.097	20-18	Brass	7376	7376UXX5				
.105	20-18	Brass	7405	7405UXX5				

FE Series

- .63" (16,0 mm) Overall Length.
- .28" (7,1 mm) Round Barrel Length.
- Round barrel with wide inside diameter range: from .060" (1,5 mm) to 1.05" (26,7 mm).
- 1/4" (6,4 mm) spacing between connectors for quick, easy attachment.
- Conductor crimp ears only.
- Available only in continuous strip form, regular (left to right) wind.
- DFARS Compliant

Now Available in Single Reel Order Quantities!

* Heyco high volume Application Tooling, designed for 3-5 ton presses - see page 8-59.

Heyco Mini Applicators, designed for 1.5-3 ton bench top presses, are available - see page 8-59.

** "XX" represents Wire Gauge. Please specify Wire Gauge when ordering.

† Short Insulation.

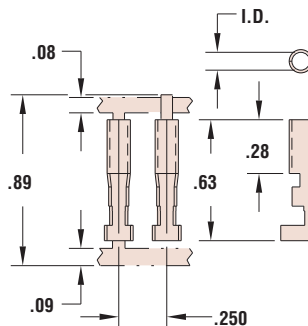

FE Series

Materials

Alloy 260 Brass (70% Cu, 30% Zn. Higher Cu content resists dezincification)

Tin-Pl = Brass, Tin plated before or after stamping

Post-Ni = Brass, Nickel plated after stamping

Quick Specs

Now Available
in Single Reel
Order Quantities!



Heyco® Specialty Female Connectors

For mating Male Pins, see pages 8-45 & 8-46

For Female Ground Pins, see pages 8-41 & 8-44

1330 Series

- **D-Shape Barrel** for better contact.
- .125" (3,2 mm) mating Male Pin diameter for all Part Nos. in Series 1330
 - Available in (3) different lengths: .33" (8,4 mm), .45" (11,4 mm) and .61" (15,5 mm).
 - Assembly dies available for crimping 1, 2 or 3 conductors simultaneously.
- 1/4" (6,4 mm) spacing between connectors for quick, easy attachment.
- Conductor crimp ears only.
- Available only in continuous strip form, regular (left to right) wind and reverse (right to left) wind.
- DFARS Compliant

JH & JHB Series

- .87" (22,1 mm) Overall Length.
- .50" (12,7 mm) **Round Barrel** Length.
- Conductor crimp ears only.
- Available only in continuous strip form, regular (left to right) wind.
- DFARS Compliant

Heater Cord Connector

- 3 wiping legs assure excellent **electrical continuity**.
- Features flaps below crimp for added **strain relief** when placed in a housing.
- Mates with a .156" (4,0 mm) diameter Male Pin.
- DFARS Compliant

Inside Dia. in.	Barrel Length in.	PART DATA			PART NO.	Die**	APPLICATION TOOLING*			
		Overall Length in.	AWG Range	Material			Feeds	Tool Packs	Crimp Punch	Anvil
1330 Series										
.122	.610	.950	24-18	Brass	7357	7357UXX5	Right to Left or	B580R/B581R B578R/B579R	C792 C737	C793 C738
					7359†	7359UXX5	Left to Right or	B582L/B583L B584L/B585L	C026 C030	C035 C037
					7358†	7358UXX5	Right to Left or	B582R/B583R B584R/B585R	C026 C030	C035 C037
	.330	.670	18-16	Brass	7366	7366UXX5	Left to Right or	B572L/B573L B574L/B575L	C020 C024	C034 C036
					7364	7364UXX5				
					7360	7360UXX5	Right to Left or	B572R/B573R B574R/B575R	C020 C024	C034 C036
.450	.800	18-16	Brass	7361	7361UXX5					

JH Series - 3-Finger Crimp

.105	.500	.870	18-16	Brass	7535	7535UXX5	Left to Right	B524L/B525L	C362	C367
.122	.500	.870	18-16	Brass	7540	7540UXX5				
.153	.500	.870	18-16	Brass	7545	7545UXX5				

JHB Series - Swedged Crimp

.105	.500	.870	18-16	Brass	7610	7610UXX5	Left to Right	B526L/B527L	C580	C581
.122	.500	.870	18-16	Brass	7615	7615UXX5				
.153	.500	.870	18-16	Brass	7620	7620UXX5				

Heater Cord Connector

.156	-	-	18-14	Brass	7530	7530UXX5	Left to Right	B970L/B971L	C701	C697
------	---	---	-------	-------	------	----------	---------------	-------------	------	------

* Heyco high volume Application Tooling, designed for 3-5 ton presses - see page 8-59.

Heyco Mini Applicators, designed for 1.5-3 ton bench top presses, are available - see page 8-59.

** "XX" represents Wire Gauge. Please specify Wire Gauge when ordering.

† With Insulation Crimp for strain relief and wire support for insertion into the housing.

1330 Series

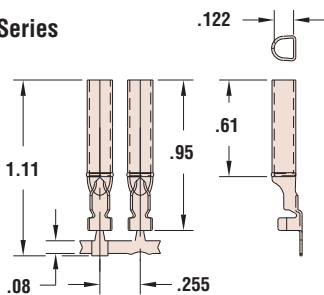

JH Series

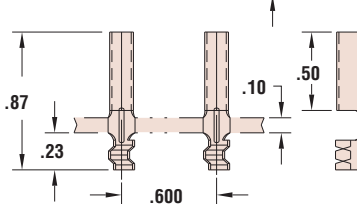

JHB Series

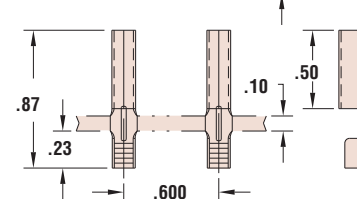

Heater Cord Connector

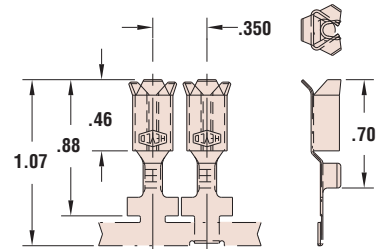

Quick
Specs

Material

Alloy 260 Brass (70% Cu, 30% Zn. Higher Cu content resists dezincification)

Heyco® Female Cord Connectors

For mating Male Blades, see pages 8-27 thru 8-34

For Female Ground Pins, see pages 8-41 & 8-44.

Type	PART DATA		PART NO.	APPLICATION TOOLING*				
	AWG Range	Material		Die**	Feeds	Tool Packs	Crimp Punch	Anvil
1152 Series								
Wiping Contact	18-12	Brass Tin-PI	7277	7277UXX5	Left to Right	B406L/B407L	C504	C510
			7274	7274UXX5				
1155 Series								
Wiping Contact	18-12	Brass Tin-PI	7279	7279UXX5	Left to Right	B410L/B411L	C283	C291
			7273	7273UXX5				
	22-16	Brass	8048	8048UXX5				
1155-90 Series†								
Wiping Contact 90°		Brass	7261	-	Bulk	-	-	-
ECN60 Series - Low Temperature								
Edge Connector	18-14	Brass Brass	7231	7231UXX5	Left to Right Right to Left	B962L/B963L B962R/B963R	C686	C687
			7230	7230UXX5				
EC60 Series - Low Temperature								
Edge Connector	18-14 14-10	Brass Brass	7225	7225UXX5	Left to Right Left to Right	B416L/B417L B950L/B951L	C293 C632	C302 C636
			7227	7227UXX5				
1120 Series								
Wiping Contact	14-12	Brass	7241	7241UXX5	Left to Right	B404L/B405L	C399	C401

* Use the Heyco Universal Applicator Die (indicated by "U" in the Die Part No.), page 8-59.

** "XX" represents Wire Gauge. Please specify Wire Gauge when ordering.

† For additional Heyco PCB Contacts, see page 8-38.

1152 Series



EC Series



1120 Series



1152 & 1155 Series

- Wiping design for maximum contact between surfaces.
- Available in strip form only.
- 1152 made from .027" material; 1155 made from .020" material.
- Part No. **8048** features a dual crimp.
- DFARS Compliant

1155-90 Series

- Wiping design for maximum contact between surfaces.
- Designed for **Circuit Board** use.
- Available in bulk form only.
- For additional PCB Connectors see page 7-22.
- DFARS Compliant

ECN60 & EC60 Series

- .0275" (0,7 mm) thick material.
- Edge Connector design.
- Meet UL and CSA **low temperature** insertion requirements.
- Available in strip form only.
- DFARS Compliant

1120 Series

- This is a heavy duty Female Wiping Contact Blade, see page 8-27.
- DFARS Compliant

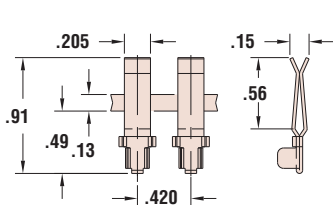

1152 Series

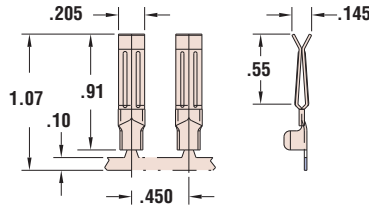

1155 Series

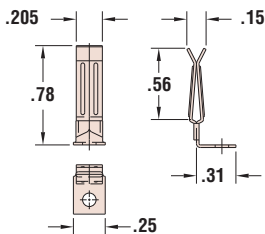

1155-90 Series

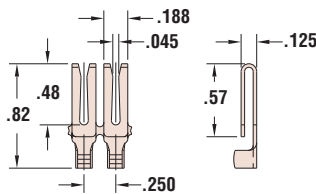

ECN60 & EC60 Series

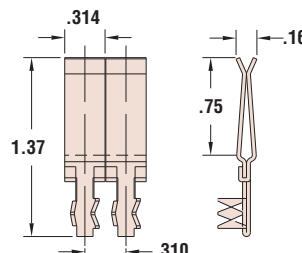

1120 Series

Materials

Alloy 260 Brass (70% Cu, 30% Zn. Higher Cu content resists dezincification)
Tin-PI = Brass, Tin plated before or after stamping

Quick
Specs

Heyco® Male Pins Mating Chart - Pages 8-45 and 8-46

MALE PART DATA			PART NOS.		
Dia. in.	AWG Range	Material	Male	Mating Female	Mating Female Series
MP075 Series					
.075	20-18	Brass	7010	7381	FE
MP089 Series					
.089	20-18	Brass	7012	-	-
		Tin-Pl	7013	-	-
		Post-Silver	7011	-	-
MP093 Series					
.093	20-18	Brass	7002	7395	FE
		Tin-Pl	7003	7380	
	20-18	Brass	7000	7395	
		Tin-Pl	7001	7380	
	20-18	Tin-Pl	7004	7380	TVR
		16-14	Brass	7008	
	Tin-Pl		7009	7299	
	MP109 Series				
.109	20-18	Brass	7032	7305	TVR
		Tin-Pl	7033	-	-
	20-18	Brass	7030	7405	FE
		Tin-Pl	7031	-	-
	20-18	Brass	7034	7405	FE
		Tin-Pl	7035	-	-
	16-14	Brass	7049	7283	1200
		Tin-Pl	7050	7284	
	16-14	Brass	7047	7283	
		Tin-Pl	7048	7284	

Consult Heyco for parts lacking mates.

MALE PART DATA			PART NOS.			
Dia. in.	AWG Range	Material	Male	Mating Female	Mating Female Series	
MP122 Series						
.122	16-14	Tin-Pl	7055	-	-	
MP125 Series						
.125	20-18	Brass	7062	7357, 7358 or 7359*	1330	
		Tin-Pl	7060 7061			
	20-18	Brass	7064		7360, 7361, 7364 or 7366*	1330
		Tin-Pl	7065			
	16-14	Brass	7068	7073		
		Tin-Pl	7069			
	16-14	Tin-Pl	7073	7076		
		Tin-Pl	7076			
MP141 Series						
.141	18-16	Brass	7171	-	-	
MP156 Series						
.156	18-16	Brass	7181	7620	JHB	
		Tin-Pl	7183	-	-	
	18-16	Brass	7180	7620	JHB	
MP178 Series						
.178	18-14	Brass	7194	-	-	
		Tin-Pl	7195	-	-	
	12-10	Brass	7192	-	-	
Tin-Pl		7193	-	-		

*These are Brass 1330 Series Specialty Females, differing in feed direction and insulation crimp.

Please consult Heyco for parts lacking mates.

Heyco® Specialty Pins Mating Chart

Page 8-42

• DFARS Compliant

MALE PART DATA			PART NO.	
Dia. in.	AWG Range	Material	Male	Mating Female Series
PCB				
.187	-	Brass	5940	1500, 1526, 1530
.187	-	Brass	5907	and 1550 Series
.125	-	Tin-Pl	8050	1330 Series
Electric Blanket				
.125	26-18	Brass	7086	1330 Series

Medical Pins - Consult Heyco for .178" Diameter Mates

Quick Specs

Materials

Alloy 260 Brass (70% Cu, 30% Zn. Higher Cu content resists dezincification)
Tin-Pl = Brass, Tin plated before or after stamping
Post-Ni = Brass, Nickel plated after stamping

Heyco® Multi-Connectors for Extension Cords

For mating Male Blades, see pages 8-29 thru 8-34.

For Male Ground Pins, see pages 8-39 & 8-40.

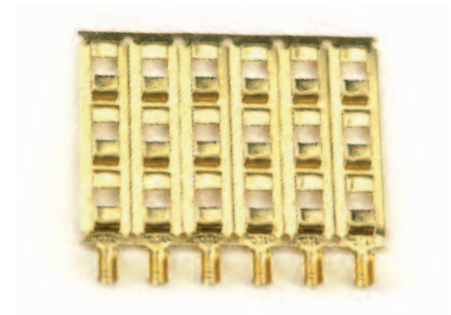

Cube Tap Female

Type	PART DATA			PART NO.	APPLICATION TOOLING*				
	AWG Range	Contact Gap in.	Material		Die**	Feeds	Tool Packs	Crimp Punch	Anvil
POL	18-14	.045	Brass	7249	7249UXX5	Left to Right	B718L/B719L	C091	C097
		.055	Brass	7250	7250UXX5				
		.050	Brass	7252	7252UXX5				

* Use the Heyco Universal Applicator Die (indicated by “U” in the Die Part No.), page 8-59.

** “XX” represents Wire Gauge. Please specify Wire Gauge when ordering.

• DFARS Compliant

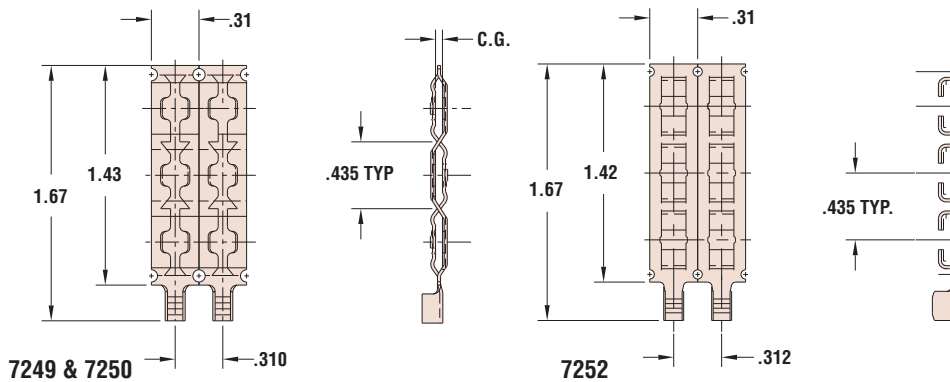

Web-Foot Female

Type	PART DATA			PART NO.	APPLICATION TOOLING*			
	AWG Range	Contact Gap in.	Material		Die**	Feeds	Crimp Punch	Anvil
Blade	16-12	n/a	Brass	8070	8070SXX5	Bulk	0W52	0W53
Ground	16-12	n/a	Brass	8072	8072SXX5	Bulk	0V60	0V61

* Use the Heyco Standard Applicator Die (indicated by “S” in the Die Part No.), page 8-59.

** “XX” represents Wire Gauge. Please specify Wire Gauge when ordering.

• DFARS Compliant

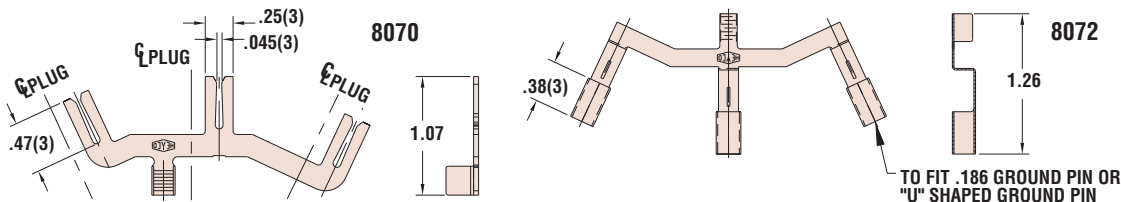

Material Alloy 260 Brass (70% Cu, 30% Zn. Higher Cu content resists dezincification)

Quick Specs

“Stay Connected” with



Power Components

a PennEngineering® Company



Heyco® Multi-Connectors for Power Blocks In-Line Power Block Females

- DFARS Compliant

Type	PART DATA			PART NO.	APPLICATION TOOLING*				
	AWG Range	Material			Die**	Feeds	Tool Packs	Crimp Punch	Anvil
Female Blade .045"	18-14	Brass		8079					
Female Blade .055"	18-14	Brass		8080	-	Bulk	-	-	-
Female Ground	18-14	Brass		8081					
(Short) Female Blade	18-14	Brass		8084	8084UXX5	Left to Right	B978L/B979L	C918, C919 & C920	C912
(Short) Female Ground	18-14	Brass		8085	8085UXX5	Left to Right	B980L/B981L	C926, C927 & C928	C923

* Use the Heyco Universal Applicator Die (indicated by "U" in the Die Part No.), page 8-59.

** "XX" represents Wire Gauge. Please specify Wire Gauge when ordering.

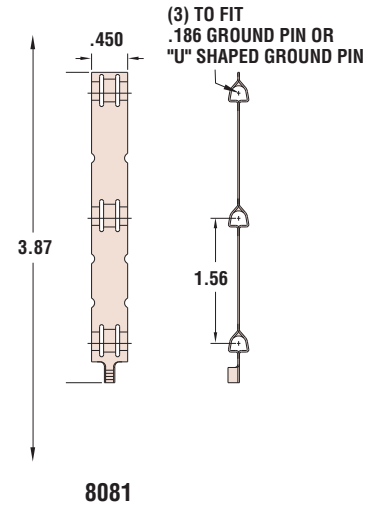
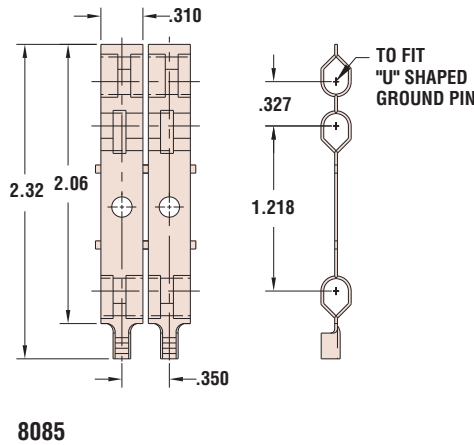
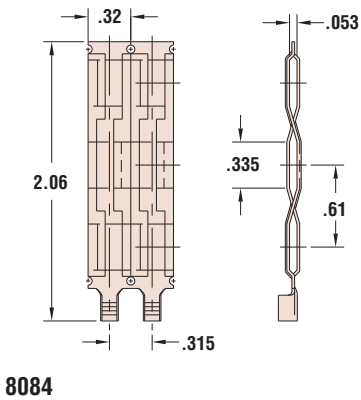
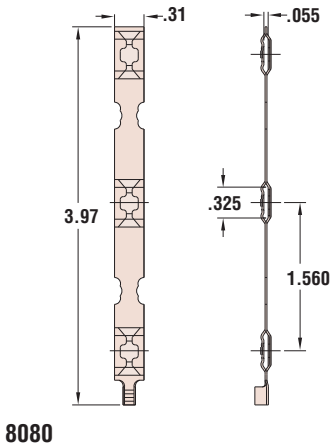

Quick Specs

Material

Alloy 260 Brass (70% Cu, 30% Zn. Higher Cu content resists dezincification)

“Stay Connected” with



Power Components

a PennEngineering® Company

Heyco® Multi-Connectors for Power Blocks

For mating Male Blades, see pages 8-29 thru 8-34.

For Ground Pins, see pages 8-39 & 8-40.

In-Line Power Block Females



Type	PART DATA		PART NO.	APPLICATION TOOLING*				
	AWG Range	Material		Die**	Feeds	Tool Packs	Crimp Punch	Anvil
Female Blade	16-12	Brass	8086	-	Bulk	-	0W52	0W53
Female Ground	16-12	Brass	8088†	-	Bulk	-	0V60	0V61
		Brass	8089	8089SXX5				

• DFARS Compliant

* Use the Heyco Universal Applicator Die (indicated by “S” in the Die Part No.), page 8-59.

** “XX” represents Wire Gauge. Please specify Wire Gauge when ordering.

† Consult Heyco for Part No. 8088 drawing; crimp location is different from 8089 (pictured).

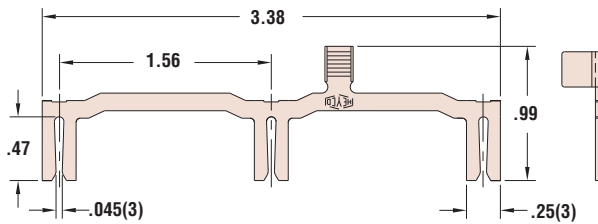

8086

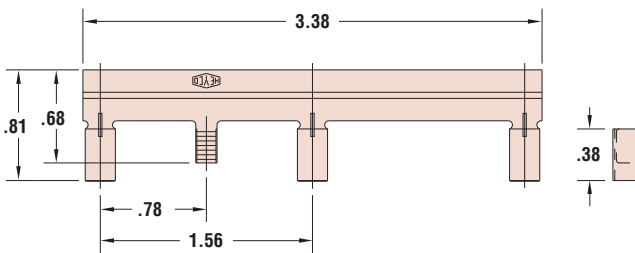

8088

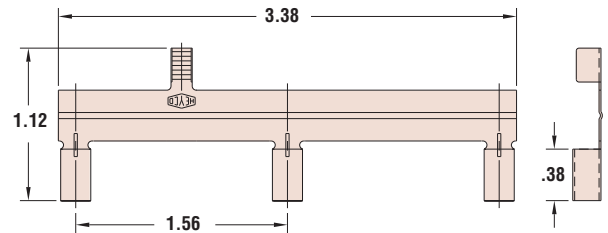

8089

Material

Alloy 260 Brass (70% Cu, 30% Zn. Higher Cu content resists dezincification)

*Quick
Specs*



Heyco® Male/Female Combination Terminals – 27 Gauge

Full Thickness Combination Blades - .058" Mold Line Thickness

For Heyco's complete line of Full Thickness Blades, see pages 8-31 thru 8-34.

1186 Series

- Typical use is 3 to 2 wire grounding adapters and piggy-back current taps.
- Narrow at female end to allow for use of stronger mold loading pins.
- Female end is a wiping contact.
- 1.59" (40.4 mm) overall length.
- Available in bulk only.
- For less costly Padded version see **1189 Series** on page 8-57.
- DFARS Compliant

1186-C Series

- Same as 1186 Series except conductor has crimping ears.
- Features a **notched blade** for high temperature pull-out requirements.
- Available in both bulk and strip form.
- For **lower cost** Padded version see page 8-57.
- DFARS Compliant

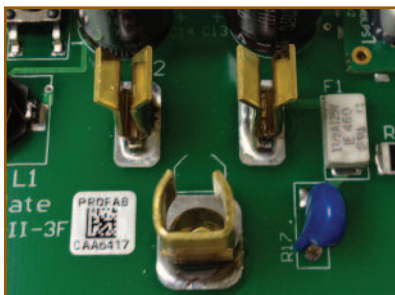
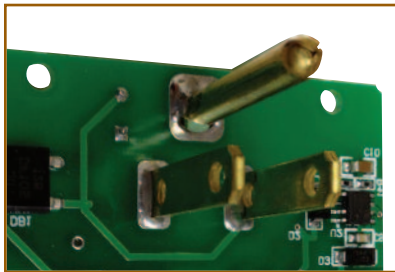

Overall Length in.	PART DATA			PART NO.		APPLICATION TOOLING*				
	Type	Width in.	Material	Non-polarized	Polarized	Die**	Feeds	Crimp Punch	Anvil	
1186 Series - Flat Blades										
1.59	Blade	.250	Brass	6305	-	-	Bulk	-	-	
	Blade	.313	Brass	-	6313†					
	Neutral	.250	Brass	-	6314†					
1186-C Series - Flat Blades with Crimp										
1.59	Blade	.250	Brass	6304	-	-	Bulk	-	-	
				6306	-	6306SXX5	Left to Right	019C	021C	
	Blade	.313	Brass	-	6310††	6310SXX5				
	Neutral	.250	Brass							

* Use the Heyco Standard Applicator Die (indicated by "S" in the Die Part No.), page 8-59.

** "XX" represents Wire Gauge. Please specify Wire Gauge when ordering.

† Parts are not UL Recognized and **must be purchased together in equal quantities.**

†† Polarized pair in strip form, not UL Recognized.

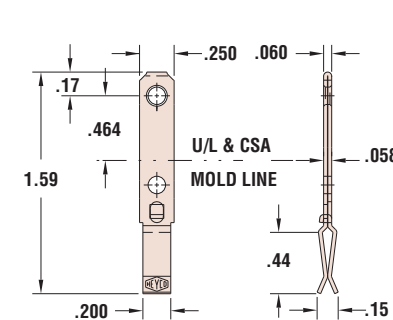

6305

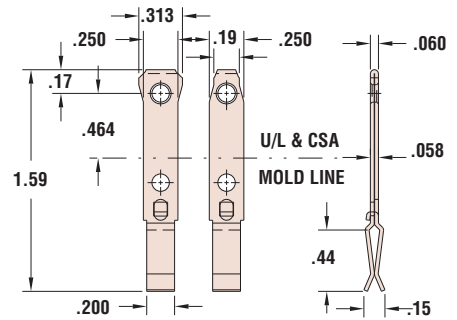

6313 & 6314 (must be purchased together)

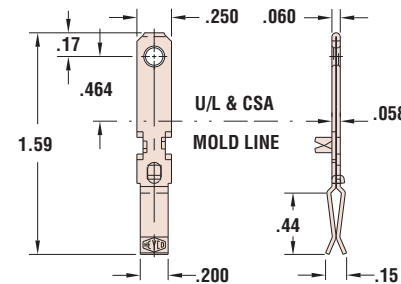

6304 (bulk) & 6306 (strip)

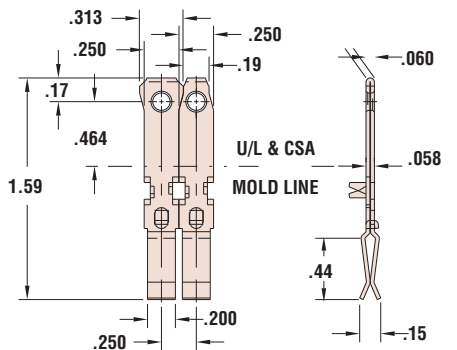

6310

Quick Specs

Material
Certifications

Alloy 260 Brass (70% Cu, 30% Zn. Higher Cu content resists dezincification)
Recognized Component under UL File E164169

“Stay Connected” with



Power Components

a PennEngineering® Company

Heyco® Male/Female Combination Terminals – 27 Gauge

Full Thickness Combination Blades - .058" Mold Line Thickness

For Heyco’s complete line of Full Thickness Blades, see pages 8-31 thru 8-34.



Overall Length in.	PART DATA			PART NO.		Feeds
	Type	Width in.	Material	Non-polarized	Polarized	
1191 Series - 7-Shape						
1.95	Blade	.250	Brass	6363	-	Bulk
	Blade	.313	Brass	-	6364†	
	Neutral	.250	Brass	-	6365†	

† Parts must be purchased together in equal quantities.

- Double spring form construction.
- Long length suitable for use in serial plugs.
- Female end is a wiping contact.
- 1.95" (49,5 mm) overall length.
- 7-Shape Blades feature a retention ledge to maintain position during overmolding (mold stop).
- Available in bulk only.
- DFARS Compliant

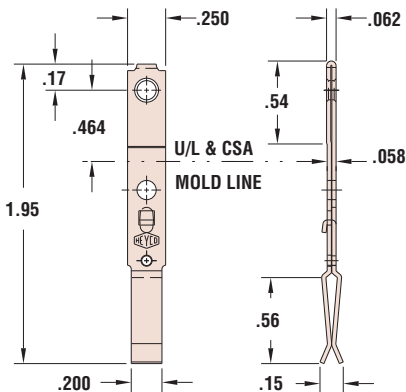

6363

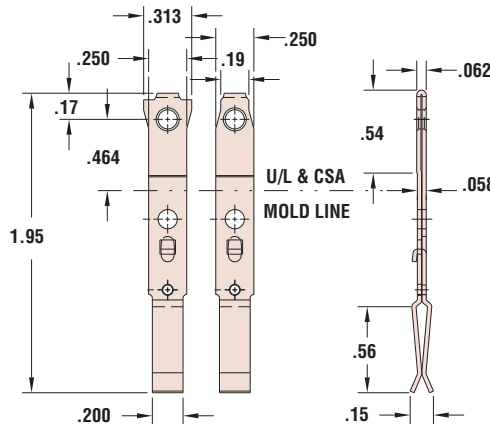

6364 & 6365 (must be purchased together)

Material Alloy 260 Brass (70% Cu, 30% Zn. Higher Cu content resists dezincification)
 Certifications Recognized Component under UL File E164169

Quick Specs

“Stay Connected” with



Power Components

a PennEngineering® Company



- Interchangeable with **1186 Series**, page 8-53.
- Higher temper, thinner material for lower cost, yet these Padded Blades are **functionally equivalent** to their Full thickness counterparts.
- Female end is a wiping contact.
- 1.59” (40,4 mm) overall length.
- Available in bulk only.
- DFARS Compliant

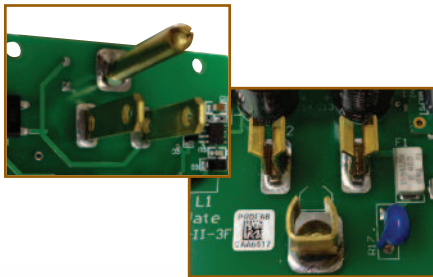

Heyco® Male/Female Combination Terminals - 20 Gauge

Padded Combination Blades - .043” Mold Line Thickness

For Heyco’s complete line of Padded Blades, see pages 8-29 & 8-30.

Overall Length in.	PART DATA			PART NO.		Feeds
	Type	Width in.	Material	Non-polarized	Polarized	
1189 Series						
1.59	Blade	.250	Brass	6320	-	Bulk
	Blade	.313	Brass	-	6321	
	Neutral	.250	Brass	-	6322	

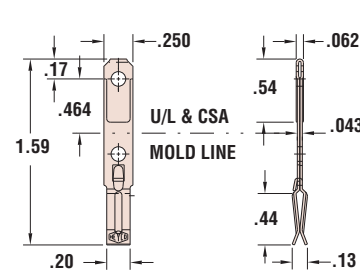

1189 Series Non-Polarized

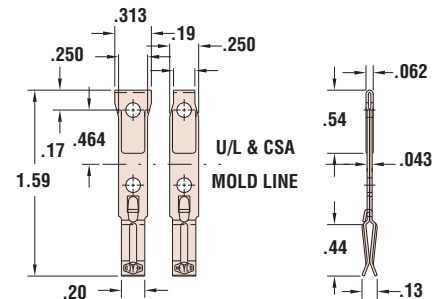

1189 Series Polarized

Heyco® Combination Ground Pins

For Heyco’s complete line of Ground Pins, see pages 8-39 thru 8-44.

Overall Length in.	PART DATA			PART NO.		Feeds
	Type	Mate Dia. in.	Material			
1125 Series - Round Barrel						
1.88	Ground Pin	.187	Brass	7245	Bulk	
				7246		Right to Left
2.13	Long Ground Pin	.187	Brass	7247	Bulk	
1526 Series - D-Shape Barrel						
1.08	D-Shape	.187	Brass	7347	Bulk	

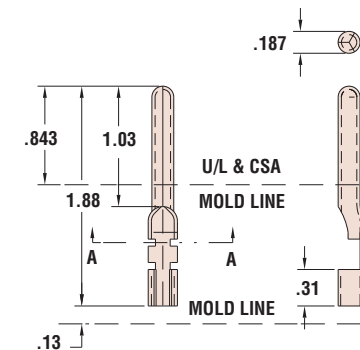

1125 Series

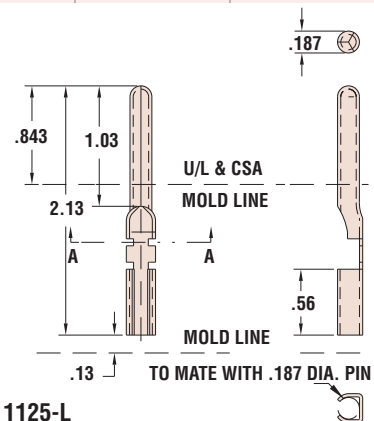

1125-L

- For grounding type adapters, series plugs and piggy-back current taps.
- **1125 Series** parts are grounding pin/ground connectors, compatible with ALL Combination Terminals on pages 8-55 thru 8-57.
- **1526 Series** parts are terminal lug/ground connectors designed for circuit boards or “3 to 2” wire grounding adapters or converters. For use with **1186 and 1189 Series** Combination Terminals, pages 8-55 and above.
- DFARS Compliant

Quick Specs

Material	Alloy 260 Brass (70% Cu, 30% Zn. Higher Cu content resists dezincification)
Certifications	Recognized Component under UL File E164169

Applicator Ordering Guidelines and Press Specifications...

To order a Heyco® Applicator:

Please provide your customer service representative with the following:

1. Correct Heyco part number
2. American Wire Gauge (AWG) you will be using with the Heyco part number (AWG replaces the "XX" that appears under the Die column in the tabular charts).
3. Shut height of your press
4. Sample of the wire you are using

Press Specifications:

For Universal and Standard Applicators:

1. 3.0 to 5.0 tons depending on terminal
2. Universal: 1.00-1.50" (25,4 – 38,1 mm) stroke 4.00-5.00" (101,6 – 127,0 mm) shut height
3. Standard: 1.50" (38,1 mm) stroke 5.00" (127,0 mm) shut height
4. Diameter of mounting hole for shank 1.00" (25,4 mm)

For Heyco® Mini Applicators:

1. 1.5 to 3.0 tons depending on terminal
2. 1.575" to 1.181" (30 – 40 mm) stroke
3. 5.346" (135,8 mm) shut height
4. Mounting mini die T style coupling

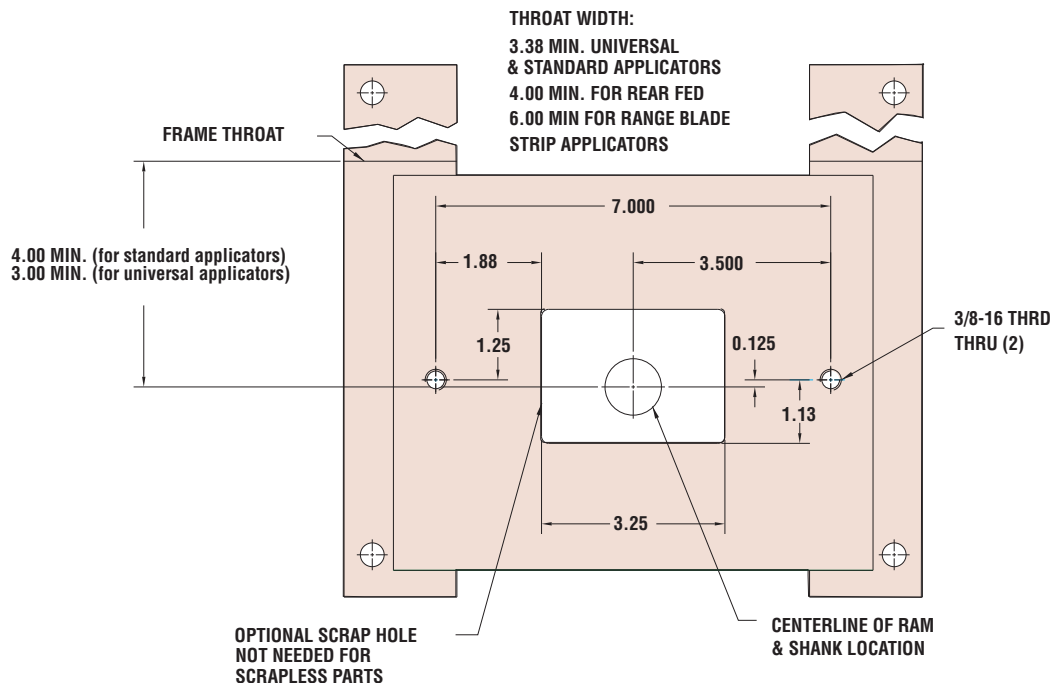

Heyco® Application Equipment

Universal Assembly Die–Applicator Die

Modular design allows the application of a wide variety of terminals in one die set. The top and bottom “tool packs” are replaced to apply different types of terminals. Adjustable feed: left-to-right or right-to-left. Adjustable stroke: fits most standard 3 and 5 ton presses. Easy crimp height adjustments. New feed and drag design make for simple consistent feed adjustments.

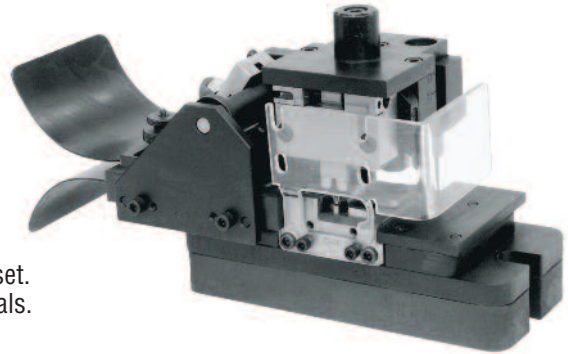

Standard Applicator Die

Required for some Heyco® terminals. Fits in standard bench presses with 5” shut height and 1-1/2” stroke. Left-to-right and right-to-left or rear feed.

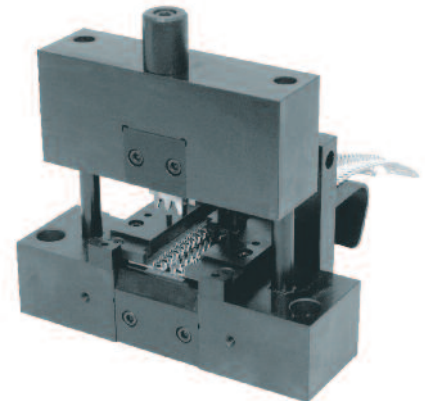

Heyco Mini Applicators

Quick change Mini-Applicators compatible with industry standard 1.5 - 3 ton presses available. Consult Heyco with your specific application needs.

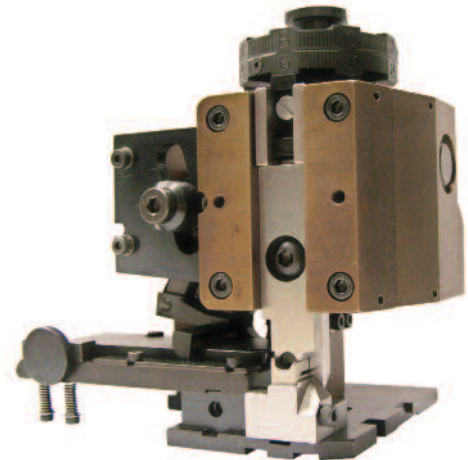

For use with the following Heyco parts.

DESCRIPTION	PAGE NO.	PART NO.
Heyco Ring and Spade Terminals	8-15, 8-16	All
	8-13, 8-14	All
Heyco Quick Connect Terminals	8-8	4750, 4751
	8-9	4838, 4834, 4835
Heyco Padded Male Blades	8-29	All
Heyco Full Thickness Male Blades	8-31	All
	8-33	None
Heyco .187” Diameter Ground Pins - Male & Female	8-39, 8-41	All
Heyco Specialty Pins	8-42	All
Heyco Male Pins	8-45, 8-46	All
Heyco Female Pin Connectors - Round Barrel	8-47	All
Heyco Female Pin Connectors - Round Barrel with Insulation Crimp	8-48	All
Heyco Specialty Female Connectors	8-49	All

For Ordering Instructions and Press Specifications, see page 8-58

Heyco[®] Application Equipment

Semi-Automatic Application Systems for Heyco Female and Male “Bridges” only, pages 8-22 thru 8-24

This equipment provides accurate, easy termination of all three contacts at once for Heyco’s **Male and Female Preassembled Cordset Components**. Parts are bowl or gravity fed into the application die eliminating the need for operator placement. The unique funnel design provides precise placement of the wire in the contacts crimps. A Stripping unit can be added to prepare the wire prior to termination.

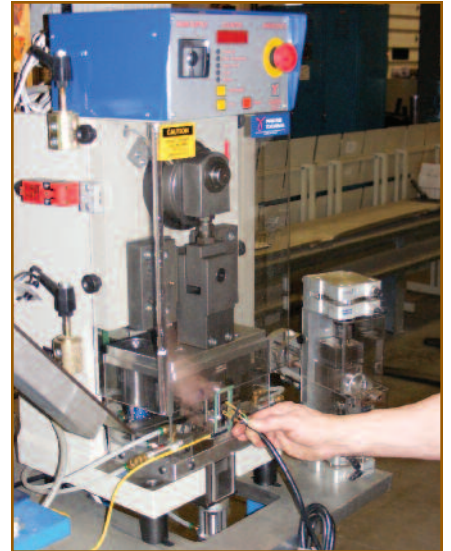
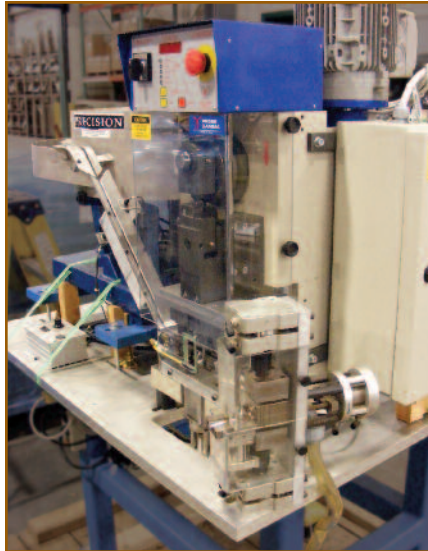

Wire Stripper

Heyco now offers a Wire Stripping Unit for use with our Semi-Automatic Application Systems. This unit will cut and strip to length the inner jacket of your wire. It also preforms the wire for faster insertion when using our Semi-Automatic Application Systems.

Order the Z464 Wire Stripper Assembly Base with the appropriate wire gauge tooling shown:

- Z462 Wire Stripper (18 Ga.)
- Z498 Wire Stripper (16 Ga.)
- Z499 Wire Stripper (14 Ga.)
- Z590 Wire Stripper (12 Ga.)
- Z591 Wire Stripper (10 Ga.)

The wire gauge tooling is interchangeable if various wire gauges are required.

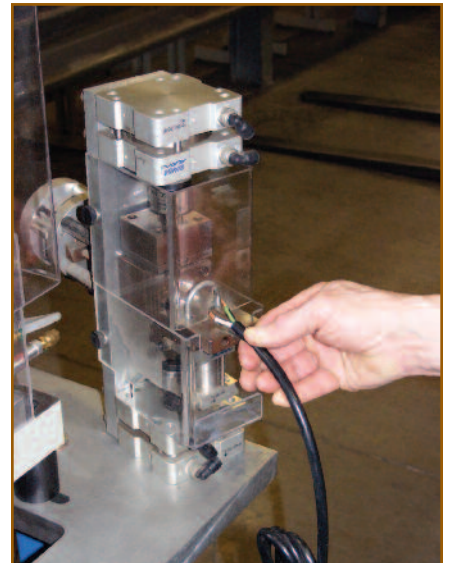

Visit heyco.com for video on training and usage

“Stay Connected” with



Power Components

a PennEngineering® Company

Stay Connected with Heyco® for All of Your Stamping Needs

Heyco's modern and efficient high-speed Stamping Room has presses from 22 to 60 tons for **high speed production of blades, pins, terminals, female contacts, and other power components.**

These presses, along with our auxiliary equipment and highly trained technicians, can accommodate a large variety of custom stampings in ferrous and nonferrous materials in addition to our core lines of 110V and 220V electrical components.

High speed application equipment and tooling are available to speed the use of our products and **save you money**, while our **on-site tool shop** provides **fast turnaround** for tool maintenance, repair and modification.

Heyco® Specialty Power Cords





Heyco[®] Custom Turn-2-Lock (T2L) Cord and Plug Sets Male and Female Configurations

New Heyco[®] Custom Turn-2-Lock Cord and Plug Sets are specifically designed for use in highbay and lowbay lighting, display cases, commercial cooking, laundry, construction, and other specialty equipment where the possibility of the male and female ends of the plug becoming easily disconnected is not an option.

- We offer 12" to 15+ feet Turn-2-Lock Whips in both Male and Female NEMA configurations.
- Popular 125, 250, 277, 347, and 480 Volt; with 15, 20, and 30 Amp NEMA configurations available.
- Standard colors are Black and White. Consult Heyco for custom colors.
- And please consult Heyco for special Lengths, applied Terminations and Strain Reliefs, and **other Custom configurations not shown**. Turn-2-Lock can be supplied with a Strain Relief, Metallic or Non-Metallic Cordgrip, and/or a Ring or other Terminal(s) already attached, to save time and reduce cost in your assembly process.
- For ease of assembly into the panel, we can assemble a Snap-In Self-Locking Strain Relief or Snap-In Cordgrip Strain Relief to your Cordset.
- For additional UL approved wire types such as SJTOW, SJTOOW, STW, and STOOW, consult Heyco.

At Heyco we use only

Alloy 260 (70/30 Brass-higher Cu content resists dezincification)

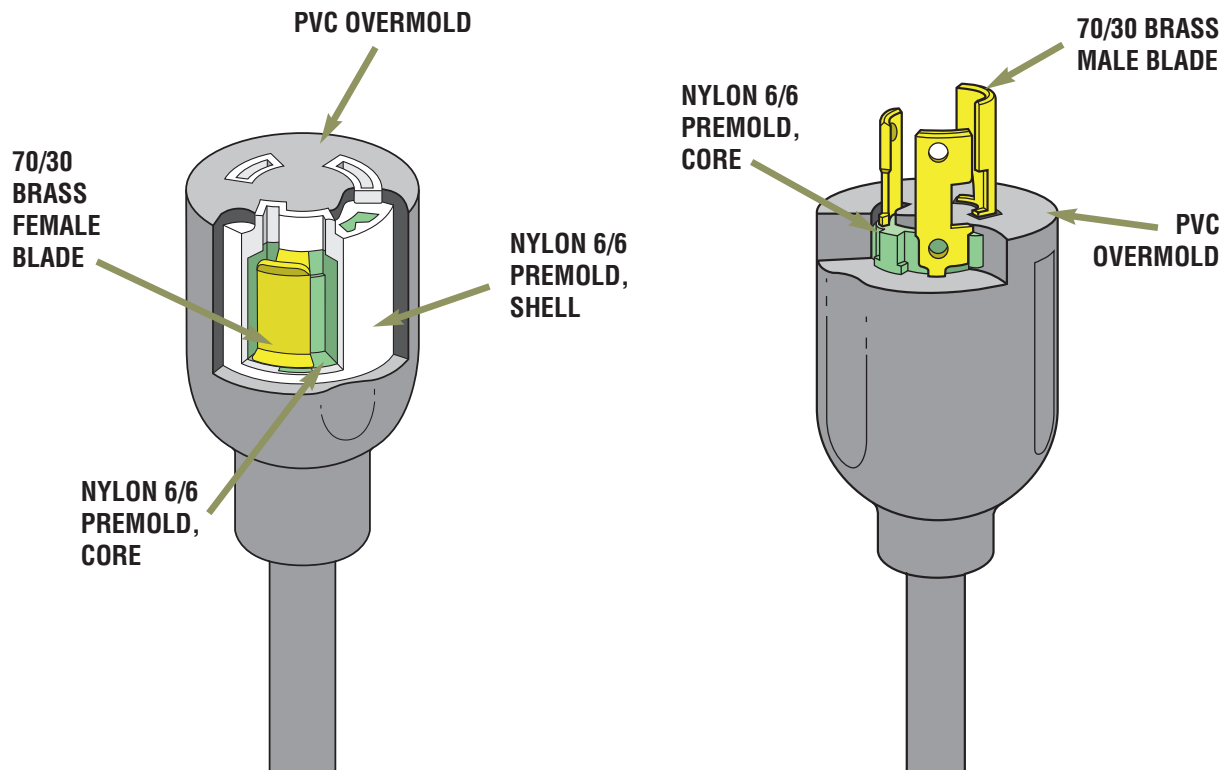

Custom Female T2L Configurations

Recognized for Use in the U.S. and Canada Under File E217650

Part No.	Description	Color	Wire		Overall Length A in.	ROJ B in.	Strip Length C in.	Ring Terminal Part No.	Strain Relief	
			Gauge AWG/Cond	Type					Part No.	D in.
L5-15R, 12 Gauge										
S7610AI	FT2L 125V-15A	Black	12-3	SJTW	24	2.5	1/2	8145	-	-
S7610	FT2L 125V-15A	Black	12-3	SJTW	36	2.5	1/2	8145	-	-
S7611	FT2L 125V-15A	White	12-3	SJTW	36	2.5	1/2	8145	-	-
S7612	FT2L 125V-15A	Black	12-3	STOW	36	2.5	1/2	8145	-	-
S7610QQ	FT2L 125V-15A	Black	12-3	SJTW	48	5	1/2	8145	-	-
S7612AQ	FT2L 125V-15A	Black	12-3	STOW	54	15	1/2	8145	-	-
S7610NN	FT2L 125V-15A	Black	12-3	SJTW	60	2.5	1/2	8145	-	-
S7612NN	FT2L 125V-15A	Black	12-3	STOW	60	2.5	1/2	8145	-	-
S7612WW	FT2L 125V-15A	Black	12-3	STOW	66	6	1/2	8145	-	-
S7610AH	FT2L 125V-15A	Black	12-3	SJTW	72	2.5	1/2	8145	-	-
S7612BR	FT2L 125V-15A	Black	12-3	STOW	72	2.5	5/8	-	-	-
S7612SS	FT2L 125V-15A	Black	12-3	STOW	84	2.5	1/2	8145	-	-
S7612BK	FT2L 125V-15A	Black	12-3	STOW	96	2.5	5/8	-	-	-
S7612AE	FT2L 125V-15A	Black	12-3	STOW	120	2.5	5/8	-	-	-
L5-20R, 12 Gauge										
S7743BM	FT2L 125V-20A	Black	12-3	SJTW	12	5	1/2	-	1865	6
S7743BH	FT2L 125V-20A	Black	12-3	SJTW	24	3.5	1/2	-	1865	4.5
S7743	FT2L 125V-20A	Black	12-3	SJTW	36	2.5	1/2	8145	-	-
S7744	FT2L 125V-20A	White	12-3	SJTW	36	2.5	1/2	8145	-	-
S7750	FT2L 125V-20A	Black	12-3	STOW	36	2.5	1/2	8145	-	-
S7750ZZ	FT2L 125V-20A	Black	12-3	STOW	36	6	1/2	8145	-	-
S7750B	FT2L 125V-20A	Black	12-3	STOW	60	5	1/2	-	-	-
S7750WW	FT2L 125V-20A	Black	12-3	STOW	66	6	1/2	8145	-	-
S7743AW	FT2L 125V-20A	Black	12-3	SJTW	72	5	1/2	-	-	-
L7-15R, 12 Gauge										
S7733	FT2L 277V-15A	Black	12-3	SJTW	36	2.5	1/2	8145	-	-
S7734	FT2L 277V-15A	White	12-3	SJTW	36	2.5	1/2	8145	-	-

Commonly Applied Turn-2-Lock Accessories

Ring Terminals		
PART NO.	DESCRIPTION	Page
6072	.265, HD 8-12 AWG	8-15
8123	#8, 20-14 AWG	8-16
8125	#10, 20-14 AWG	8-16
8145	#10, 12 AWG	8-16
8147	#10, 10 AWG	8-16

Strain Relief Devices		
PART NO.	DESCRIPTION	Page
1859	RDD 301-2 Black	4-8
1860	RDD 301-2 White	4-8
1865	RDD 401 Black	4-8
3231	LTF 1/2 NPT Black	3-19
4539	Brass CG Pg11-120	3-35
4545	Brass CG Pg16-150	3-35
4547	Brass CG Pg21-160	3-35

- DFARS Compliant

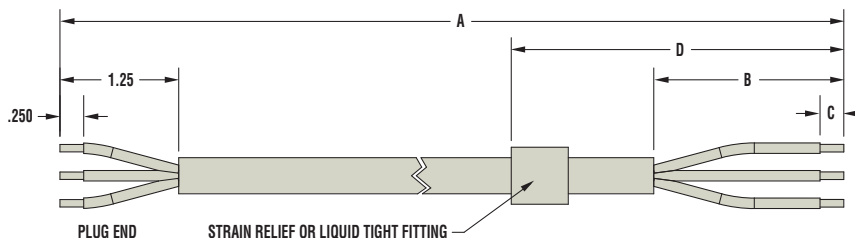

Custom Male T2L Configurations

Listed for Use in the U.S. and Canada Under File E217650

Part No.	Description	Color	Wire		Overall Length A in.	ROJ		Strip Length C in.	Ring Terminal Part No.	Strain Relief	
			Gauge AWG/Cond	Type		B in.	D in.				
L5-15P, 16 Gauge											
S7650	T2L 125V-15A	Black	16-3	SE00W	36	2.5	1/2	8125	-	-	
S7651	T2L 125V-15A	White	16-3	SE0W	36	2.5	1/2	8125	-	-	
S7650W	T2L 125V-15A	Black	16-3	SE00W	36	2.5	5/8	-	-	-	
S7651E	T2L 125V-15A	White	16-3	SE0W	36	5.5	1/2	8125	1859	6.5	
S7651W	T2L 125V-15A	White	16-3	SE0W	36	2.5	5/8	-	-	-	
S7651D	T2L 125V-15A	White	16-3	SE0W	42	3	1/2	-	-	-	
S7651XX	T2L 125V-15A	White	16-3	SE0W	48	2.5	1/2	8125	-	-	
S7650G	T2L 125V-15A	Black	16-3	SE00W	72	2.5	1/2	8125	-	-	
S7651FF	T2L 125V-15A	White	16-3	SE0W	72	2.5	5/8	-	-	-	
S7651G	T2L 125V-15A	White	16-3	SE0W	72	2.5	1/2	8125	-	-	
S7651AU	T2L 125V-15A	White	16-3	SE0W	78	4	1/2	8125	-	-	
S7651AB	T2L 125V-15A	White	16-3	SE0W	84	2.5	5/8	-	-	-	
S7650I	T2L 125V-15A	Black	16-3	SE00W	96	2.5	1/2	8125	-	-	
S7651BK	T2L 125V-15A	White	16-3	SE0W	96	2.5	5/8	-	-	-	
S7651AC	T2L 125V-15A	White	16-3	SE0W	108	2.5	5/8	-	-	-	
S7650BA	T2L 125V-15A	Black	16-3	SE00W	120	2.5	1/2	8125	-	-	
S7651AE	T2L 125V-15A	White	16-3	SE0W	120	2.5	5/8	-	-	-	
L5-15P, 14 Gauge											
S7655	T2L 125V-15A	Black	14-3	SJT	36	2.5	1/2	8145	-	-	
S7656	T2L 125V-15A	White	14-3	SJT	36	2.5	1/2	8145	-	-	
L5-15P, 12 Gauge											
S7657AI	T2L 125V-15A	Black	12-3	SJTW	24	2.5	1/2	8145	-	-	
S7652	T2L 125V-15A	Black	12-3	STOW	36	2.5	1/2	8145	-	-	
S7657	T2L 125V-15A	Black	12-3	SJTW	36	2.5	1/2	8145	-	-	
S7658	T2L 125V-15A	White	12-3	SJTW	36	2.5	1/2	8145	-	-	
S7657QQ	T2L 125V-15A	Black	12-3	SJTW	48	5	1/2	8145	-	-	
S7652NN	T2L 125V-15A	Black	12-3	STOW	60	2.5	1/2	8145	-	-	
S7657NN	T2L 125V-15A	Black	12-3	SJTW	60	2.5	1/2	8145	-	-	
S7652AD	T2L 125V-15A	Black	12-3	STOW	66	2	5/8	-	-	-	
S7652WW	T2L 125V-15A	Black	12-3	STOW	66	6	1/2	8145	-	-	
S7657AH	T2L 125V-15A	Black	12-3	SJTW	72	2.5	1/2	8145	-	-	
S7652SS	T2L 125V-15A	Black	12-3	STOW	84	2.5	1/2	8145	-	-	
L5-20P, 16 Gauge											
S7640	T2L 125V-20A	Black	16-3	SE00W	36	2.5	1/2	8125	-	-	
S7640BQ	T2L 125V-20A	Black	16-3	SE00W	36	5	1/2	-	-	-	
S7641BQ	T2L 125V-20A	White	16-3	SE0W	36	5	1/2	-	-	-	
S7640A	T2L 125V-20A	Black	16-3	SE00W	54	6	1/2	8125	3231	8	
S7640B	T2L 125V-20A	Black	16-3	SE00W	60	5	1/2	-	-	-	
S7640G	T2L 125V-20A	Black	16-3	SE00W	72	2.5	1/2	8125	-	-	
S7641RR	T2L 125V-20A	White	16-3	SE0W	96	5	1/2	8125	-	-	
S7640VV	T2L 125V-20A	Black	16-3	SE00W	108	6	1/2	8125	3231	8	

- DFARS Compliant

Custom Male T2L Configurations continued

Listed for Use in the U.S. and Canada Under File E217650

Part No.	Description	Color	Wire		Overall Length A in.	ROJ		Strip Length C in.	Ring Terminal Part No.	Strain Relief	
			Gauge AWG/Cond	Type		B in.	D in.				
L5-20P, 14 Gauge											
S7613	T2L 125V-20A	Black	14-3	SJT	36	2.5	1/2	8145	-	-	-
S7614	T2L 125V-20A	White	14-3	SJT	36	2.5	1/2	8145	-	-	-
S7645	T2L 125V-20A	Black	14-3	SEOW	36	2.5	1/2	8145	-	-	-
S7646	T2L 125V-20A	White	14-3	SEOW	36	2.5	1/2	8145	-	-	-
S7645QQ	T2L 125V-20A	Black	14-3	SEOW	48	5	1/2	8145	-	-	-
S7645B	T2L 125V-20A	Black	14-3	SEOW	60	5	1/2	-	-	-	-
L5-20P, 12 Gauge											
S7647BL	T2L 125V-20A	Black	12-3	SJTW	12	5	1/2	8145	1865	6	-
S7647BG	T2L 125V-20A	Black	12-3	SJTW	24	3.5	1/2	8145	1865	4.5	-
S7642	T2L 125V-20A	Black	12-3	STOW	36	2.5	1/2	8145	-	-	-
S7642ZZ	T2L 125V-20A	Black	12-3	STOW	36	6	1/2	8145	-	-	-
S7647	T2L 125V-20A	Black	12-3	SJTW	36	2.5	1/2	8145	-	-	-
S7648	T2L 125V-20A	White	12-3	SJTW	36	2.5	1/2	8145	-	-	-
S7647BI	T2L 125V-20A	Black	12-3	SJTW	36	6	1/2	-	-	-	-
S7642AA	T2L 125V-20A	Black	12-3	STOW	54	6	1/2	-	-	-	-
S7642B	T2L 125V-20A	Black	12-3	STOW	60	5	1/2	-	-	-	-
S7642WW	T2L 125V-20A	Black	12-3	STOW	66	6	1/2	8145	-	-	-
S7642AC	T2L 125V-20A	Black	12-3	STOW	108	2.5	5/8	-	-	-	-
L5-30P, 12 Gauge											
S7715	T2L 125V-30A	Black	12-3	SJO	36	2.5	1/2	8145	-	-	-
S7716	T2L 125V-30A	Black	12-3	SJTO	36	2.5	1/2	8145	-	-	-
S7717	T2L 125V-30A	Black	12-3	SJT	36	2.5	1/2	8145	-	-	-
L5-30P, 10 Gauge											
S7718	T2L 125V-30A	Black	10-3	SJT	36	2.5	1/2	8145	-	-	-
S7718BI	T2L 125V-30A	Black	10-3	SJT	36	6	1/2	-	-	-	-
L6-15P, 16 Gauge											
S7690	T2L 250V-15A	Black	16-3	SEOW	36	2.5	1/2	8125	-	-	-
S7690W	T2L 250V-15A	Black	16-3	SEOW	36	2.5	5/8	-	-	-	-
S7691	T2L 250V-15A	White	16-3	SEOW	36	2.5	1/2	8125	-	-	-
S7691E	T2L 250V-15A	White	16-3	SEOW	36	5.5	1/2	8125	1859	6.5	-
S7691W	T2L 250V-15A	White	16-3	SEOW	36	2.5	5/8	-	-	-	-
S7691D	T2L 250V-15A	White	16-3	SEOW	42	3	1/2	-	-	-	-
S7690G	T2L 250V-15A	Black	16-3	SEOW	72	2.5	1/2	8125	-	-	-
S7691FF	T2L 250V-15A	White	16-3	SEOW	72	2.5	5/8	-	-	-	-
S7691AU	T2L 250V-15A	White	16-3	SEOW	78	4	1/2	8125	-	-	-
S7691C	T2L 250V-15A	White	16-3	SEOW	78	4	1/2	8125	1859	6	-
S7690HH	T2L 250V-15A	Black	16-3	SEOW	84	6	5/8	-	-	-	-

- DFARS Compliant

Don't see the configuration you need?

Consult Heyco for your particular NEMA Plug; wire gauge, type, length, and color; and Strain Relief and Termination requirements. Our Axcell® rapid development team is ready to meet your design requirements.

“Stay Connected” with



Specialty Power Cords

a PennEngineering® Company

Custom Male T2L Configurations continued

cUL^{us} Listed for Use in the U.S. and Canada Under File E217650

Part No.	Description	Color	Wire		Overall Length A in.	ROJ		Strip Length C in.	Ring Terminal Part No.	Strain Relief	
			Gauge AWG/Cond	Type		B in.	D in.				
L6-15P, 14 Gauge											
S7695	T2L 250V-15A	Black	14-3	SJT	36	2.5	1/2	8145	-	-	-
S7696	T2L 250V-15A	White	14-3	SJT	36	2.5	1/2	8145	-	-	-
S7695G	T2L 250V-15A	Black	14-3	SJT	72	2.5	1/2	8145	-	-	-
L6-30P, 12 Gauge*											
S7705	T2L 250V-30A	Black	12-3	SJT	36	2.5	1/2	8145	-	-	-
S7710	T2L 250V-30A	Black	12-3	STOW	36	2.5	1/2	8145	-	-	-
S7710Q	T2L 250V-30A	Black	12-3	STOW	78	4	1/2	-	4547	5	-
L6-30P, 10 Gauge											
S7700	T2L 250V-30A	Black	10-3	SJT	36	2.5	1/2	6072	-	-	-
S7708	T2L 250V-30A	Black	10-3	STOOW	36	2.5	1/2	6072	-	-	-
L7-15P, 16 Gauge											
S7630	T2L 277V-15A	Black	16-3	SE00W	36	2.5	1/2	8125	-	-	-
S7631	T2L 277V-15A	White	16-3	SE0W	36	2.5	1/2	8125	-	-	-
S7631BQ	T2L 277V-15A	White	16-3	SE0W	36	5	1/2	-	-	-	-
S7631E	T2L 277V-15A	White	16-3	SE0W	36	5.5	1/2	8125	1859	6.5	-
S7631W	T2L 277V-15A	White	16-3	SE0W	36	2.5	5/8	-	-	-	-
S7631D	T2L 277V-15A	White	16-3	SE0W	42	3	1/2	-	-	-	-
S7630FF	T2L 277V-15A	Black	16-3	SE00W	72	2.5	5/8	-	-	-	-
S7630G	T2L 277V-15A	Black	16-3	SE00W	72	2.5	1/2	8125	-	-	-
S7631FF	T2L 277V-15A	White	16-3	SE0W	72	2.5	5/8	-	-	-	-
S7631G	T2L 277V-15A	White	16-3	SE0W	72	2.5	1/2	8125	-	-	-
S7631AU	T2L 277V-15A	White	16-3	SE0W	78	4	1/2	8125	-	-	-
S7631C	T2L 277V-15A	White	16-3	SE0W	78	4	1/2	8125	1859	6	-
S7630H	T2L 277V-15A	Black	16-3	SE00W	84	3	1/2	8125	-	-	-
S7630HH	T2L 277V-15A	Black	16-3	SE00W	84	6	5/8	-	-	-	-
S7631HH	T2L 277V-15A	White	16-3	SE0W	84	6	5/8	-	-	-	-
S7630I	T2L 277V-15A	Black	16-3	SE00W	96	2.5	1/2	8125	-	-	-
S7631BK	T2L 277V-15A	White	16-3	SE0W	96	2.5	5/8	-	-	-	-
S7631AC	T2L 277V-15A	White	16-3	SE0W	108	2.5	5/8	-	-	-	-
S7631J	T2L 277V-15A	White	16-3	SE0W	108	6	5/8	-	-	-	-
S7630AZ	T2L 277V-15A	Black	16-3	SE00W	120	2.5	1/2	-	1859	3.5	-
S7630BA	T2L 277V-15A	Black	16-3	SE00W	120	2.5	1/2	-	-	-	-
S7631AE	T2L 277V-15A	White	16-3	SE0W	120	2.5	5/8	-	-	-	-
L7-15P, 14 Gauge											
S7635	T2L 277V-15A	Black	14-3	SE0W	36	2.5	1/2	8145	-	-	-
S7636	T2L 277V-15A	White	14-3	SE0W	36	2.5	1/2	8145	-	-	-
L7-15P, 12 Gauge											
S7637	T2L 277V-15A	Black	12-3	SJTW	36	2.5	1/2	8145	-	-	-
S7638	T2L 277V-15A	White	12-3	SJTW	36	2.5	1/2	8145	-	-	-

*For 12 AWG applications, the power cords are derated to 20 Amp.

- DFARS Compliant

“Stay Connected” with



Specialty Power Cords

a PennEngineering® Company

Custom Male T2L Configurations concluded

cUL_{us} Listed for Use in the U.S. and Canada Under File E217650

Part No.	Description	Color	Wire		Overall Length A in.	ROJ B in.	Strip Length C in.	Ring Terminal Part No.	Strain Relief	
			Gauge AWG/Cond	Type					Part No.	D in.
L7-20P, 16 Gauge										
S7620	T2L 277V-20A	Black	16-3	SE00W	36	2.5	1/2	8125	-	-
S7621	T2L 277V-20A	White	16-3	SE0W	36	2.5	1/2	8125	-	-
S7621BQ	T2L 277V-20A	White	16-3	SE0W	36	5	1/2	-	-	-
S7621QQ	T2L 277V-20A	White	16-3	SE0W	48	5	1/2	8145	-	-
S7620G	T2L 277V-20A	Black	16-3	SE00W	72	2.5	1/2	8125	-	-
S7620I	T2L 277V-20A	Black	16-3	SE00W	96	2.5	1/2	8125	-	-
S7621BC	T2L 277V-20A	White	16-3	SE0W	120	6	5/8	-	-	-
L7-20P, 14 Gauge										
S7625	T2L 277V-20A	Black	14-3	SJT	36	2.5	1/2	8145	-	-
S7626	T2L 277V-20A	White	14-3	SJT	36	2.5	1/2	8145	-	-
S7626QQ	T2L 277V-20A	White	14-3	SJT	48	5	1/2	8145	-	-
L24-20P, 16 Gauge										
S7660	T2L 347V-20A	Black	16-3	SE00W	36	2.5	1/2	8125	-	-
S7661	T2L 347V-20A	White	16-3	SE0W	36	2.5	1/2	8125	-	-
S7661AC	T2L 347V-20A	White	16-3	SE0W	108	2.5	5/8	-	-	-
L24-20P, 14 Gauge										
S7665	T2L 347V-20A	Black	14-3	SJT	36	2.5	1/2	8145	-	-
S7666	T2L 347V-20A	White	14-3	SJT	36	2.5	1/2	8145	-	-
S7666QQ	T2L 347V-20A	White	14-3	SJT	48	5	1/2	8145	-	-
L8-20P, 16 Gauge										
S7670	T2L 480V-20A	Black	16-3	SE00W	36	2.5	1/2	8125	-	-
S7671	T2L 480V-20A	White	16-3	SE0W	36	2.5	1/2	8125	-	-
S7671W	T2L 480V-20A	White	16-3	SE0W	36	2.5	5/8	-	-	-
S7671D	T2L 480V-20A	White	16-3	SE0W	42	3	1/2	-	-	-
S7670G	T2L 480V-20A	Black	16-3	SE00W	72	2.5	1/2	8125	-	-
S7670PP	T2L 480V-20A	Black	16-3	SE00W	72	6	5/8	-	-	-
S7671FF	T2L 480V-20A	White	16-3	SE0W	72	2.5	5/8	-	-	-
S7670HH	T2L 480V-20A	Black	16-3	SE00W	84	6	5/8	-	-	-
S7671RR	T2L 480V-20A	White	16-3	SE0W	102	5	1/2	8125	-	-
S7671AC	T2L 480V-20A	White	16-3	SE0W	108	2.5	5/8	-	-	-
S7671AE	T2L 480V-20A	White	16-3	SE0W	120	2.5	5/8	-	-	-
L8-20, 14 Gauge										
S7675	T2L 480V-20A	Black	14-3	SJT	36	2.5	1/2	8145	-	-
S7676RR	T2L 480V-20A	White	14-3	SJT	102	5	1/2	8125	-	-

- DFARS Compliant

Still don't see the configuration you need?

Consult Heyco for your particular NEMA Plug; wire gauge, type, length, and color; and Strain Relief and Termination requirements. Our Axcell® rapid development team is ready to meet your design requirements.

“Stay Connected” with



Specialty Power Cords

a PennEngineering® Company

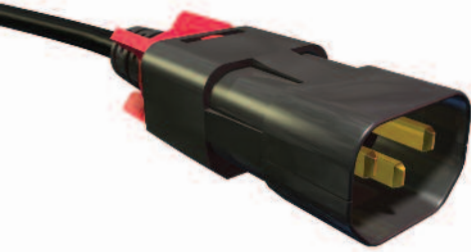

HEYlock™ Locking IEC Power Cords

Universal C13 to C14 Locking Power Cords - designed for retrofit!

UL Listed (UL 817) and CE Compliant (IEC 60320)

- The only locking IEC 13-14 power cord that locks at both ends.
- Designed for retrofit - plug and play replacement for existing power cords.
- Universally compatible - requires no mating plug or receptacle on the other side of the connection.
- Consult Heyco for IEC 19-20 power cord configurations.

Type	WIRE Gauge AWG/ Cond	Color *	Length *		PART NO.	DESCRIPTION
			Feet	M		
H05	17/3	Black	1.7	0.5	S8000	HPC-C13/C14-17/3-BLK-H05-1.7
			3.3	1.0	S8002	HPC-C13/C14-17/3-BLK-H05-3.3
			5.0	1.5	S8004	HPC-C13/C14-17/3-BLK-H05-5.0
			6.6	2.0	S8006	HPC-C13/C14-17/3-BLK-H05-6.6
			8.3	2.5	S8008	HPC-C13/C14-17/3-BLK-H05-8.3
SJT	16/3	Black	1.7	0.5	S8020	HPC-C13/C14-16/3-BLK-SJT-1.7
			3.3	1.0	S8022	HPC-C13/C14-16/3-BLK-SJT-3.3
			5.0	1.5	S8024	HPC-C13/C14-16/3-BLK-SJT-5.0
			6.6	2.0	S8026	HPC-C13/C14-16/3-BLK-SJT-6.6
SJT	14/3	Black	1.7	0.5	S8030	HPC-C13/C14-14/3-BLK-SJT-1.7
			3.3	1.0	S8032	HPC-C13/C14-14/3-BLK-SJT-3.3
			5.0	1.5	S8034	HPC-C13/C14-14/3-BLK-SJT-5.0
			6.6	2.0	S8036	HPC-C13/C14-14/3-BLK-SJT-6.6

*Custom colors and lengths available, consult Heyco.



Universal C13 to 5-15P Locking Power Cords - designed for retrofit!

UL Listed (UL 817) and CE Compliant (IEC 60320)

- IEC 13 to NEMA 5-15P power cord that locks at the application end.
- Designed for retrofit - plug and play replacement for existing power cords.
- Universally compatible - requires no mating receptacle on the other side of the connection.
- IEC 13 to any International plug configuration available. Consult Heyco.

Type	WIRE Gauge AWG/ Cond	Color *	Length *		PART NO.	DESCRIPTION
			Feet	M		
SJT	18/3	Black	2.0	0.6	S8052	HPC-C13/515P-18/3-BLK-SJT-2.0
			3.0	0.9	S8053	HPC-C13/515P-18/3-BLK-SJT-3.0
			6.0	1.8	S8056	HPC-C13/515P-18/3-BLK-SJT-6.0
SJT	16/3	Black	2.0	0.6	S8062	HPC-C13/515P-16/3-BLK-SJT-2.0
			3.0	0.9	S8063	HPC-C13/515P-16/3-BLK-SJT-3.0
			6.0	1.8	S8066	HPC-C13/515P-16/3-BLK-SJT-6.0
SJT	14/3	Black	2.0	0.6	S8072	HPC-C13/515P-14/3-BLK-SJT-2.0
			3.0	0.9	S8073	HPC-C13/515P-14/3-BLK-SJT-3.0
			6.0	1.8	S8076	HPC-C13/515P-14/3-BLK-SJT-6.0

*Custom colors and lengths available, consult Heyco.

*Quick
Specs*

Materials

Nylon 6/6 and PVC with Plated Copper Alloy Contacts

Certifications

cULus Certified by UL for Compliance with both Canadian and U.S. Requirements under File E471200 (C13/C14)

cULus Certified by UL for Compliance with both Canadian and U.S. Requirements under File E115330 (C13/5-15P)

