



## Heyco® Quick Connect Terminals

See pages 8-13 & 8-14 for mating Quick Connect Females.

For Heyco Applicators, see page 8-59

### Male Terminal Tabs - .032 gauge

- All terminals feature a **rectangular “locking tab”** in center for added **strain relief** and **support** when inserted into Female connector.
- Heyco Terminals meet all your application needs with **solder**, **crimp**, and **dual male** connections.
- For schematic drawings see opposite page.
- DFARS Compliant

Crimp?	Ref Dwg	PART DATA			PART NO.	APPLICATION TOOLING*				
		Overall Length in.	AWG Range	Material		Die**	Feeds	Crimp Punch	Anvil	
<b>Solder Connection Tabs</b>										
No	4810	.65	Short	Brass	<b>4810</b>	-	Bulk	-	-	
	4833	.72	Solder	Brass	<b>4833</b>	-	Right to Left	-	-	
	8211	.73	Solder	Brass	<b>8211</b>	-	Bulk	-	-	
	4800	.81	Solder	Brass	<b>4800</b>	-	Bulk	-	-	
Yes†	8044	1.12	Solder	Brass	<b>8044</b>	-	Bulk	-	-	
	8040	1.61	Solder	Brass	<b>8040</b>	-	Bulk	-	-	
<b>Crimp Connection Tabs</b>										
Yes	4836	.64	90° Angle Crimp 18-16	Brass	<b>4836</b>	0624	Right to Left	OK24	OK25	
	4838	.71	26-18	Brass	<b>4838</b>	4838UXX5	Left to Right	C458	C463	
	4820	.81	18-16	Brass	<b>4820</b>	-	Bulk	-	-	
Brass				<b>4834</b>	4834UXX5	Left to Right	C460	C465		
<b>Dual Connection Tabs</b>										
No	4830	.83	Dual	Brass	<b>4830</b>	-	Bulk	-	-	

\* Heyco high volume Application Tooling, designed for 3-5 ton presses - see page 8-59.

Heyco Mini Applicators, designed for 1.5-3 ton bench top presses, are available for Part Nos. 4834, 4835 & 4848 only. See page 8-59.

\*\* “XX” represents Wire Gauge. Please specify Wire Gauge when ordering.

† Hook crimp located at the quick connect tab end of Terminal

Quick Specs

Materials

Alloy 260 Brass (70% Cu, 30% Zn. Higher Cu content resists dezincification)

“Stay Connected” with



Power Components

a PennEngineering® Company

## Heyco® Quick Connect Terminals

Male Terminal Tabs - .032 gauge – Schematic Drawings

### Solder Connection Tabs

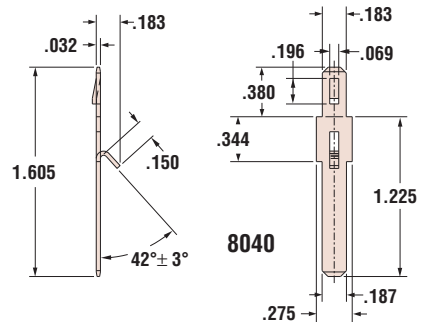
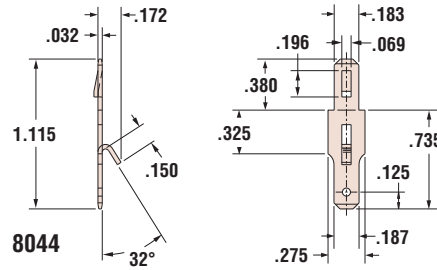
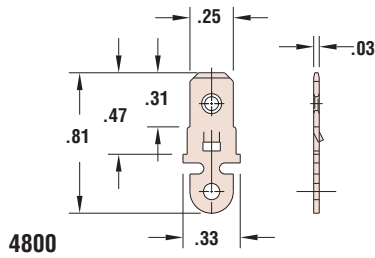
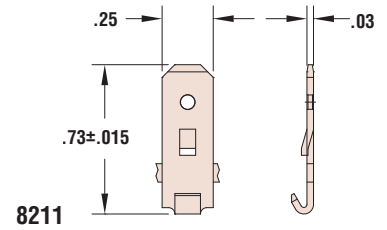
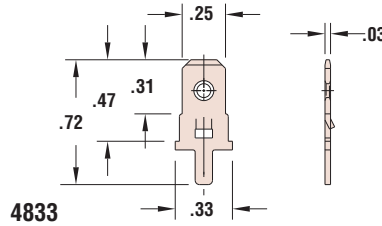
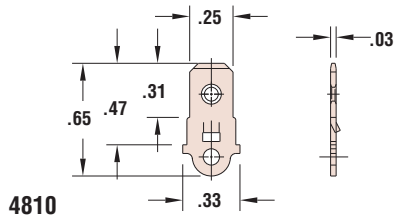

### Crimp Connection Tabs

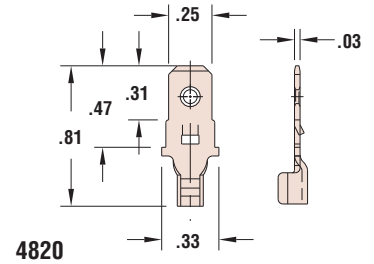
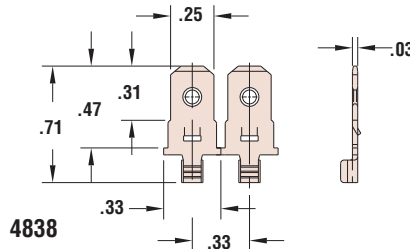
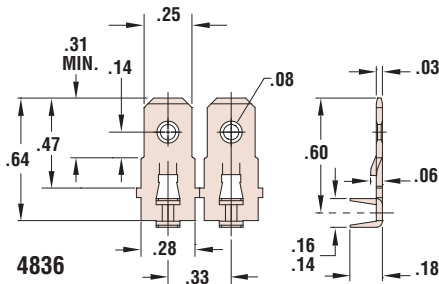

### Dual Connection Tabs

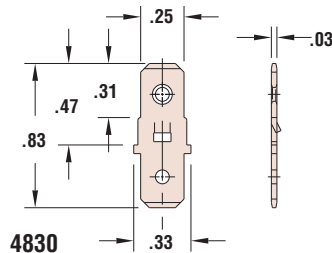

Materials

Alloy 260 Brass (70% Cu, 30% Zn. Higher Cu content resists dezincification)

Quick  
Specs